

Solenoid valves VZWD, directly actuated

FESTO



Festo core product range
Covers 80% of your automation tasks

Worldwide:

Always in stock

Superb:

Festo quality at an attractive price

Easy:

Simplified procurement and warehousing

★ Generally ready for shipping ex works in 24 hours

In stock at 13 Service Centres worldwide

More than 2200 products

★ Generally ready for shipping ex works in 5 days

Assembled for you at 4 Service Centres worldwide

Up to 6×10^{12} variants per product family

Just look
for the
star!

Key features and product range overview

General

Directly actuated solenoid valves VZWD are mainly intended for applications with high pressure ranges and low flow rates.

This type of valve switches the sealing element directly via the solenoid system. The seal generally has to lift away from the seat against the effective operating pressure using just the actuator.

A closing spring, supported by the pressure of the medium, keeps the valve closed. The function is dependent on the seat size, the effective operating pressure and the magnetic force.

The difference with respect to force pilot operated solenoid valves (VZWF) lies in the flow rate.

General

-  - Connecting thread
G1/4, G1/8

-  - Flow rate Kv
0.06 ... 0.4 m³/h

Areas of application

- Vacuum technology
- Venting gas and tank systems
- Safety shut-offs for burner controllers

Design

- Insensitive to slight contamination of the media

Advantages

- Valves switch from 0 bar up to the max. operating pressure
- Excellent sealing properties

- - Note

The valves are suitable for vacuum with Pabs > 100 mbar. Please ensure the flow direction corresponds to the direction of the arrow.

Key features and product range overview

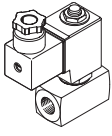
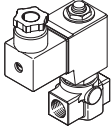
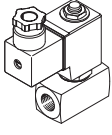
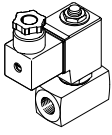
Design	Type	Valve body connection	Nominal size DN	Pressure of medium ¹⁾ [bar]	→ Page/Internet	
Brass housing						
	VZWD-L-...	G1/4	1	0 ... 50	5	
			1.5	0 ... 30		
			2	0 ... 15		
			2.5	0 ... 8		
			G1/8			1
				1.5	0 ... 30	
				2	0 ... 15	
		Brass housing				
	VZWD-L-...	G1/4	1	0 ... 90	9	
			1.5	0 ... 85		
			2	0 ... 40		
			2.5	0 ... 22		
			3	0 ... 15		
			4	0 ... 8		
			5	0 ... 5		
		6	0 ... 4			
		G1/8		1	0 ... 90	9
				1.5	0 ... 85	
				2	0 ... 40	
				2.5	0 ... 22	
				3	0 ... 15	
				4	0 ... 8	
		5	0 ... 5			
		6	0 ... 4			
Stainless steel housing						
	VZWD-L-...-R1	G1/4	1	0 ... 90	14	
			1.5	0 ... 85		
			2	0 ... 40		
			2.5	0 ... 22		
			3	0 ... 15		
			4	0 ... 8		
			5	0 ... 5		
6	0 ... 4					
	VZWD-L-...-R1	G1/8	1	0 ... 90	14	
			1.5	0 ... 85		
			2	0 ... 40		
			2.5	0 ... 22		
			3	0 ... 15		
			4	0 ... 8		
			5	0 ... 5		
6	0 ... 4					

1) The valves are suitable for vacuum with Pabs > 100 mbar. Please ensure the flow direction corresponds to the direction of the arrow.

Type codes

001	Series	
VZWD	Solenoid valve, directly actuated	

002	Directional control valve type	
L	In-line valve	

003	Valve function	
M22C	2/2-way valve, normally closed	

004	Reset method for monostable/single solenoid valves	
M	Mechanical spring	

005	Process valve connection	
G14	G1/4	
G18	G1/8	

006	Nominal width [mm]	
10	10	
15	15	
20	20	
25	25	
30	30	
40	40	
50	50	
60	60	

007	Sealant	
V	FPM	

008	Nominal operating voltage	
1	24 V DC	
2A	110 V AC/50-60 Hz	
3A	230 V AC/50-60 Hz	

009	Electrical connection	
P4	Plug socket, 3-wire	

010	Pressure of medium [bar]	
4	4	
5	5	
8	8	
15	15	
22	22	
30	30	
40	40	
50	50	
85	85	
90	90	

011	Corrosion protection	
	Standard	
R1	Stainless steel	

Data sheet – Brass housing, nominal pressure PN 50

Function

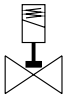

-  - Connecting thread
G1/4, G1/8

-  - Flow rate Kv
0.06 ... 0.16 m³/h



General technical data		1.0	1.5	2.0	2.5
Nominal size DN		1.0	1.5	2.0	2.5
Valve function		2/2-way, single solenoid, closed			
Design		Directly actuated poppet valve			
Type of mounting		In-line installation			
Actuation type		Electrical			
Reset method		Mechanical spring			
Flow direction		Non-reversible			
Type of control		Direct			
Manual override		None			
Mounting position		Any			
Sealing principle		Soft			
Max. viscosity	[mm ² /s]	22			
Degree of protection		IP65			

Operating and environmental conditions		1.0	1.5	2.0	2.5
Nominal size DN		1.0	1.5	2.0	2.5
Standard nominal flow rate	[l/min]	60	95	140	170
Flow rate Kv	[m ³ /h]	0.06	0.09	0.13	0.16
Nominal pressure of fitting PN		50			
Medium		Compressed air to ISO 8573-1:2010 [7:4:4]			
		Inert gases			
		Mineral oil			
		Neutral fluids			
		Water			
		Other flow media on request			
Pressure difference	[bar]	0			
Ambient temperature	[°C]	-10 ... +35°C			
Temperature of medium	[°C]	-10 ... +80°C			
Leak rate to EN 12266-1		A			
Corrosion resistance class CRC ¹⁾		1			

1) Corrosion resistance class CRC 1 to Festo standard FN 940070

Low corrosion stress. Dry indoor application or transport and storage protection. Also applies to parts behind covers, in the non-visible interior area, and parts which are covered in the application (e.g. drive trunnions).

Data sheet – Brass housing, nominal pressure PN 50

Electrical data			
Operating voltage		24 V DC	110 V AC 230 V AC
Electrical connection	Plug to EN 175301-803 type A, square design		
CE marking		–	73/23/EEC 73/23/EEC
Insulation class		H	F F
Duty cycle	[%]	100	
Permissible voltage fluctuations	[%]	±10	
Switching time on	[ms]	25	
Switching time off	[ms]	10	
Characteristic coil data			
Direct current DC	[V]	24	– –
Alternating current AC	[V]	–	110 230
Power consumption	[W]	6.8	– –
Pick-up power	[VA]	–	10.5 10.5
Holding power	[VA]	–	8 7.6
	[Hz]	–	50, 60 50, 60
Materials			
Solenoid valves			Material number
Housing	High-alloy stainless steel		1.4305
	Brass		CW614N
Seals	FPM		
Note on materials	Contains paint-wetting impairment substances		
	RoHS-compliant		

Data sheet – Brass housing, nominal pressure PN 50

Dimensions

Download CAD data → www.festo.com

Milled brass housing

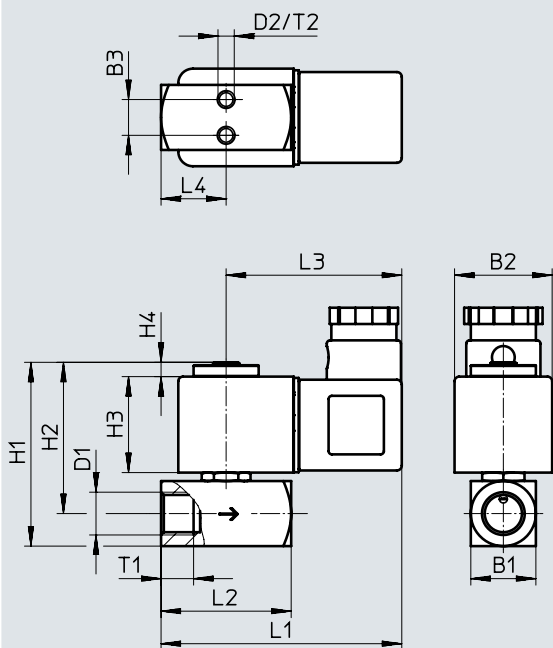

Type	B1	B2	B3	D1	D2	H1	H2	H3	H4	L1	L2	L3	L4	L5	T1	T2
VZWD-...-G1/8-10-...-50	15	30	8	G1/8	M3	52	44	30	5	70	32	54	16	-	8	4.5
VZWD-...-G1/8-15-...-30																
VZWD-...-G1/8-20-...-15																
VZWD-...-G1/4-10-...-50	20	30	11	G1/4	M5	57	47	30	5	74	40	54	20	-	10	5.5
VZWD-...-G1/4-15-...-30																
VZWD-...-G1/4-20-...-15																
VZWD-...-G1/4-25-...-8																

Data sheet – Brass housing, nominal pressure PN 50

★ Core product range

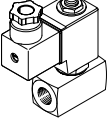
Ordering data							
	Valve body connection	Nominal width DN	Pressure of medium ¹⁾ [bar]	Product weight [g]	Operating voltage	Brass housing	
						Part no.	Type
	G1/8	1	0 ... 50	300	24 V DC	★ 1491825	VZWD-L-M22C-M-G18-10-V-1P4-50
		2	0 ... 15	300	24 V DC	★ 1491827	VZWD-L-M22C-M-G18-20-V-1P4-15

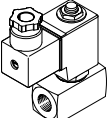
Ordering data							
	Valve body connection	Nominal width DN	Pressure of medium ¹⁾ [bar]	Product weight [g]	Operating voltage	Brass housing	
						Part no.	Type
	G1/4	1	0 ... 50	350	24 V DC	1491828	VZWD-L-M22C-M-G14-10-V-1P4-50
					110 V AC	1491906	VZWD-L-M22C-M-G14-10-V-2AP4-50
					230 V AC	1491984	VZWD-L-M22C-M-G14-10-V-3AP4-50
		1.5	0 ... 30	350	24 V DC	1491829	VZWD-L-M22C-M-G14-15-V-1P4-30
					110 V AC	1491907	VZWD-L-M22C-M-G14-15-V-2AP4-30
					230 V AC	1491985	VZWD-L-M22C-M-G14-15-V-3AP4-30
		2	0 ... 15	350	24 V DC	1491830	VZWD-L-M22C-M-G14-20-V-1P4-15
					110 V AC	1491908	VZWD-L-M22C-M-G14-20-V-2AP4-15
					230 V AC	1491986	VZWD-L-M22C-M-G14-20-V-3AP4-15
		2.5	0 ... 8	350	24 V DC	1491831	VZWD-L-M22C-M-G14-25-V-1P4-8
					110 V AC	1491909	VZWD-L-M22C-M-G14-25-V-2AP4-8
					230 V AC	1491987	VZWD-L-M22C-M-G14-25-V-3AP4-8

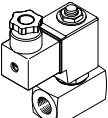
Ordering data							
	Valve body connection	Nominal width DN	Pressure of medium ¹⁾ [bar]	Product weight [g]	Operating voltage	Brass housing	
						Part no.	Type
	G1/8	1	0 ... 50	300	110 V AC	1491903	VZWD-L-M22C-M-G18-10-V-2AP4-50
					230 V AC	1491981	VZWD-L-M22C-M-G18-10-V-3AP4-50
		1.5	0 ... 30	300	24 V DC	1491826	VZWD-L-M22C-M-G18-15-V-1P4-30
					110 V AC	1491904	VZWD-L-M22C-M-G18-15-V-2AP4-30
					230 V AC	1491982	VZWD-L-M22C-M-G18-15-V-3AP4-30
		2	0 ... 15	300	110 V AC	1491905	VZWD-L-M22C-M-G18-20-V-2AP4-15
230 V AC	1491983				VZWD-L-M22C-M-G18-20-V-3AP4-15		

1) The valves are suitable for vacuum with Pabs > 100 mbar. Please ensure the flow direction corresponds to the direction of the arrow.

Data sheet – Brass housing, nominal pressure PN 100

Function

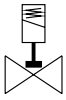

-  - Connecting thread
G1/4, G1/8

-  - Flow rate Kv
0.06 ... 0.4 m³/h

Nominal size DN
1.0 ... 6.0 mm



General technical data

Nominal size DN	1.0	1.5	2.0	2.5	3.0	4.0	5.0	6.0
Valve function	2/2-way, single solenoid, closed							
Design	Directly actuated poppet valve							
Type of mounting	In-line installation							
Actuation type	Electrical							
Reset method	Mechanical spring							
Flow direction	Non-reversible							
Type of control	Direct							
Manual override	None							
Mounting position	Any							
Sealing principle	Soft							
Max. viscosity [mm ² /s]	22							
Degree of protection	IP65							

Operating and environmental conditions

Nominal size DN	1.0	1.5	2.0	2.5	3.0	4.0	5.0	6.0
Standard nominal flow rate [l/min]	60	95	140	170	210	310	375	430
Flow rate Kv [m ³ /h]	0.06	0.09	0.13	0.16	0.2	0.3	0.35	0.4
Nominal pressure of fitting PN	100							
Pressure difference [bar]	0							
Medium	Compressed air to ISO 8573-1:2010 [7:4:4]							
	Inert gases							
	Mineral oil							
	Neutral fluids							
	Water							
	Other flow media on request							
Ambient temperature [°C]	-10 ... +35°C							
Temperature of medium [°C]	-10 ... +80°C							
Leak rate to EN 12266-1	A							
Corrosion resistance class CRC ¹⁾	1							

1) Corrosion resistance class CRC 1 to Festo standard FN 940070

Low corrosion stress. Dry indoor application or transport and storage protection. Also applies to parts behind covers, in the non-visible interior area, and parts which are covered in the application (e.g. drive trunnions).

Data sheet – Brass housing, nominal pressure PN 100

Electrical data			
Operating voltage		24 V DC	110 V AC 230 V AC
Electrical connection	Plug to EN 175301-803 type A, square design		
CE marking		–	73/23/EEC 73/23/EEC
Insulation class		H	F F
Duty cycle	[%]	100	
Permissible voltage fluctuations	[%]	±10	
Switching time on	[ms]	20	
Switching time off	[ms]	18	
Characteristic coil data			
Direct current DC	[V]	24	– –
Alternating current AC	[V]	–	110 230
Power consumption	[W]	11	– –
Pick-up power	[VA]	–	19 18
Holding power	[VA]	–	16 15
	[Hz]	–	50, 60 50, 60
Materials			
Solenoid valves			Material number
Housing	High-alloy stainless steel		1.4305
	Brass		CW614N
Seals	FPM		
Note on materials	Contains paint-wetting impairment substances		
	RoHS-compliant		

Data sheet – Brass housing, nominal pressure PN 100

Dimensions

Download CAD data → www.festo.com

Die-cast brass housing

Milled brass housing

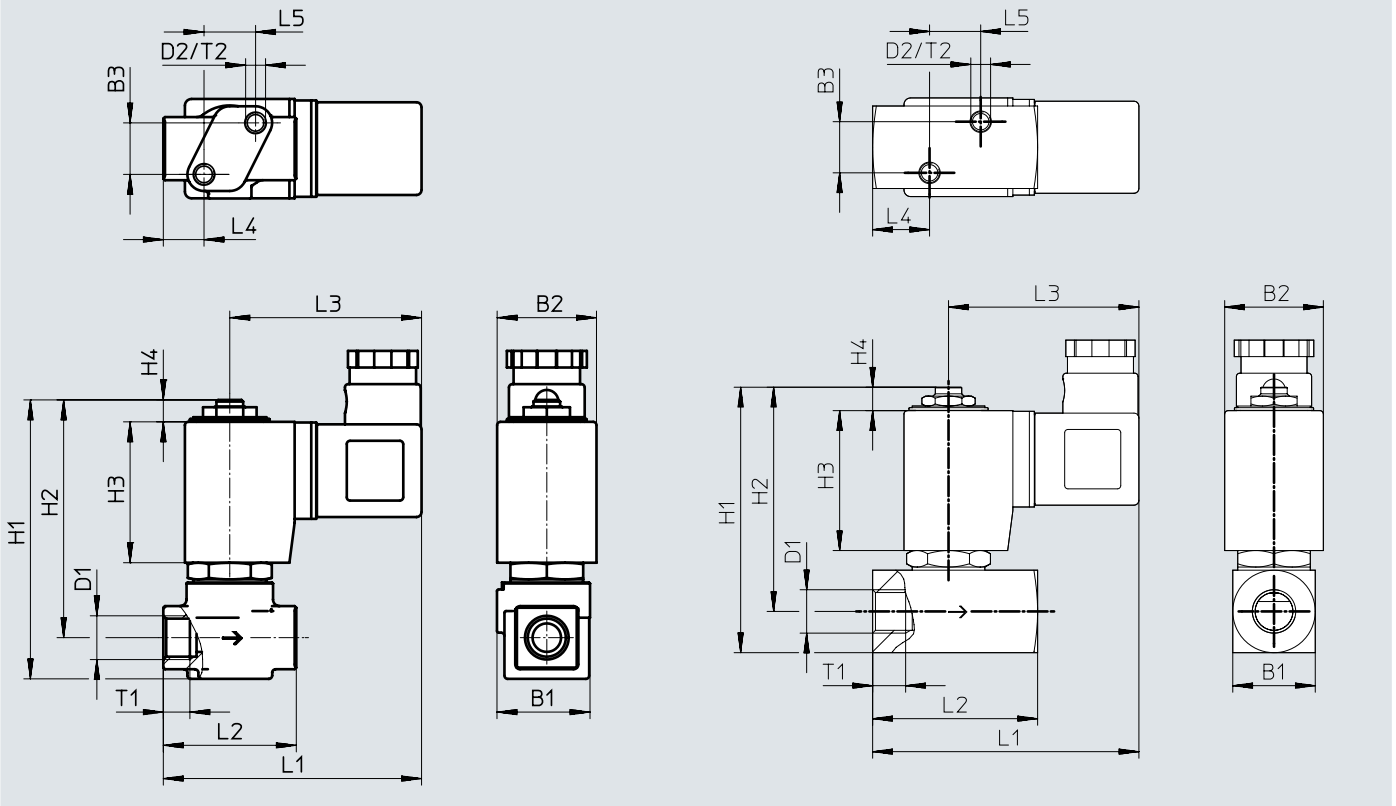



Type	B1	B2	B3	D1	D2	H1	H2	H3	H4	L1	L2	L3	L4	L5	T1	T2
VZWD-...G1/8-10-...-90	28	30	15.5	G1/8	M6	84	72	42.5	6.5	78	40	58	12	15.5	8	6
VZWD-...G1/8-15-...-85																
VZWD-...G1/8-20-...-40																
VZWD-...G1/8-25-...-22																
VZWD-...G1/8-30-...-15																
VZWD-...G1/8-40-...-8																
VZWD-...G1/4-10-...-90	28	30	15.5	G1/4	M6	84	72	42.5	6.5	78	40	58	12	15.5	10	6
VZWD-...G1/4-15-...-85																
VZWD-...G1/4-20-...-40																
VZWD-...G1/4-25-...-22																
VZWD-...G1/4-30-...-15																
VZWD-...G1/4-40-...-8																
VZWD-...G1/8-50-...-5	25	30	15.5	G1/8	M6	81	68	42.5	7	78	40	58	12	15.5	8	6
VZWD-...G1/8-60-...-4																
VZWD-...G1/4-50-...-5																
VZWD-...G1/4-60-...-4	25	30	15.5	G1/4	M6	81	68	42.5	7	85	50	58	17	15.5	10	6

Data sheet – Brass housing, nominal pressure PN 100

★ Core product range

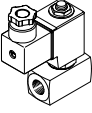
Ordering data							
Valve body connection	Nominal width DN	Pressure of medium ¹⁾ [bar]	Product weight [g]	Operating voltage	Brass housing		
					Part no.	Type	
	3	0 ... 15	550	24 V DC	★ 1491844	VZWD-L-M22C-M-G14-30-V-1P4-15	
	4	0 ... 8	550	24 V DC	★ 1491845	VZWD-L-M22C-M-G14-40-V-1P4-8	

Ordering data							
Valve body connection	Nominal width DN	Pressure of medium ¹⁾ [bar]	Product weight [g]	Operating voltage	Brass housing		
					Part no.	Type	
	6	0 ... 4	600	24 V DC	★ 1491847	VZWD-L-M22C-M-G14-60-V-1P4-4	

Ordering data							
Valve body connection	Nominal width DN	Pressure of medium ¹⁾ [bar]	Product weight [g]	Operating voltage	Brass housing		
					Part no.	Type	
	3	0 ... 15	550	24 V DC	★ 1491836	VZWD-L-M22C-M-G18-30-V-1P4-15	
	4	0 ... 8	550	24 V DC	★ 1491837	VZWD-L-M22C-M-G18-40-V-1P4-8	

Ordering data							
Valve body connection	Nominal width DN	Pressure of medium ¹⁾ [bar]	Product weight [g]	Operating voltage	Brass housing		
					Part no.	Type	
	1	0 ... 90	550	24 V DC	1491840	VZWD-L-M22C-M-G14-10-V-1P4-90	
				110 V AC	1491918	VZWD-L-M22C-M-G14-10-V-2AP4-90	
				230 V AC	1491996	VZWD-L-M22C-M-G14-10-V-3AP4-90	
	1.5	0 ... 85	550	24 V DC	1491841	VZWD-L-M22C-M-G14-15-V-1P4-85	
				110 V AC	1491919	VZWD-L-M22C-M-G14-15-V-2AP4-85	
				230 V AC	1491997	VZWD-L-M22C-M-G14-15-V-3AP4-85	
	2	0 ... 40	550	24 V DC	1491842	VZWD-L-M22C-M-G14-20-V-1P4-40	
				110 V AC	1491920	VZWD-L-M22C-M-G14-20-V-2AP4-40	
				230 V AC	1491998	VZWD-L-M22C-M-G14-20-V-3AP4-40	
	2.5	0 ... 22	550	24 V DC	1491843	VZWD-L-M22C-M-G14-25-V-1P4-22	
				110 V AC	1491921	VZWD-L-M22C-M-G14-25-V-2AP4-22	
				230 V AC	1491999	VZWD-L-M22C-M-G14-25-V-3AP4-22	
	3	0 ... 15	550	110 V AC	1491922	VZWD-L-M22C-M-G14-30-V-2AP4-15	
				230 V AC	1492000	VZWD-L-M22C-M-G14-30-V-3AP4-15	
	4	0 ... 8	550	110 V AC	1491923	VZWD-L-M22C-M-G14-40-V-2AP4-8	
				230 V AC	1492001	VZWD-L-M22C-M-G14-40-V-3AP4-8	

1) The valves are suitable for vacuum with Pabs > 100 mbar. Please ensure the flow direction corresponds to the direction of the arrow.

Data sheet – Brass housing, nominal pressure PN 100

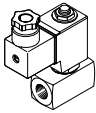
Ordering data							
	Valve body connection	Nominal width DN	Pressure of medium ¹⁾ [bar]	Product weight [g]	Operating voltage	Brass housing	
						Part no.	Type
	G1/4	5	0 ... 5	600	24 V DC	1491846	VZWD-L-M22C-M-G14-50-V-1P4-5
					110 V AC	1491924	VZWD-L-M22C-M-G14-50-V-2AP4-5
					230 V AC	1492002	VZWD-L-M22C-M-G14-50-V-3AP4-5
		6	0 ... 4	600	110 V AC	1491925	VZWD-L-M22C-M-G14-60-V-2AP4-4
					230 V AC	1492003	VZWD-L-M22C-M-G14-60-V-3AP4-4

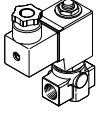
Ordering data							
	Valve body connection	Nominal width DN	Pressure of medium ¹⁾ [bar]	Product weight [g]	Operating voltage	Brass housing	
						Part no.	Type
	G1/8	1	0 ... 90	550	24 V DC	1491832	VZWD-L-M22C-M-G18-10-V-1P4-90
					110 V AC	1491910	VZWD-L-M22C-M-G18-10-V-2AP4-90
					230 V AC	1491988	VZWD-L-M22C-M-G18-10-V-3AP4-90
		1.5	0 ... 85	550	24 V DC	1491833	VZWD-L-M22C-M-G18-15-V-1P4-85
					110 V AC	1491911	VZWD-L-M22C-M-G18-15-V-2AP4-85
					230 V AC	1491989	VZWD-L-M22C-M-G18-15-V-3AP4-85
		2	0 ... 40	550	24 V DC	1491834	VZWD-L-M22C-M-G18-20-V-1P4-40
					110 V AC	1491912	VZWD-L-M22C-M-G18-20-V-2AP4-40
					230 V AC	1491990	VZWD-L-M22C-M-G18-20-V-3AP4-40
		2.5	0 ... 22	550	24 V DC	1491835	VZWD-L-M22C-M-G18-25-V-1P4-22
					110 V AC	1491913	VZWD-L-M22C-M-G18-25-V-2AP4-22
					230 V AC	1491991	VZWD-L-M22C-M-G18-25-V-3AP4-22
		3	0 ... 15	550	110 V AC	1491914	VZWD-L-M22C-M-G18-30-V-2AP4-15
					230 V AC	1491992	VZWD-L-M22C-M-G18-30-V-3AP4-15
		4	0 ... 8	550	110 V AC	1491915	VZWD-L-M22C-M-G18-40-V-2AP4-8
					230 V AC	1491993	VZWD-L-M22C-M-G18-40-V-3AP4-8

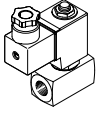

Ordering data							
	Valve body connection	Nominal width DN	Pressure of medium ¹⁾ [bar]	Product weight [g]	Operating voltage	Brass housing	
						Part no.	Type
	G1/8	5	0 ... 5	600	24 V DC	1491838	VZWD-L-M22C-M-G18-50-V-1P4-5
					110 V AC	1491916	VZWD-L-M22C-M-G18-50-V-2AP4-5
					230 V AC	1491994	VZWD-L-M22C-M-G18-50-V-3AP4-5
		6	0 ... 4	600	24 V DC	1491839	VZWD-L-M22C-M-G18-60-V-1P4-4
					110 V AC	1491917	VZWD-L-M22C-M-G18-60-V-2AP4-4
					230 V AC	1491995	VZWD-L-M22C-M-G18-60-V-3AP4-4

1) The valves are suitable for vacuum with Pabs > 100 mbar. Please ensure the flow direction corresponds to the direction of the arrow.

Data sheet – Stainless steel housing, nominal pressure PN 100

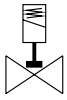
Function



-  - Connecting thread
G1/4, G1/8
-  - Flow rate Kv
0.06 ... 0.4 m³/h



General technical data

Nominal size DN	1.0	1.5	2.0	2.5	3.0	4.0	5.0	6.0
Valve function	2/2-way, single solenoid, closed							
Design	Directly actuated poppet valve							
Type of mounting	In-line installation							
Actuation type	Electrical							
Reset method	Mechanical spring							
Type of control	Direct							
Manual override	None							
Mounting position	Any							
Sealing principle	Soft							
Flow direction	Non-reversible							
Max. viscosity [mm ² /s]	22							
Degree of protection	IP65							

Operating and environmental conditions

Nominal size DN	1.0	1.5	2.0	2.5	3.0	4.0	5.0	6.0
Standard nominal flow rate [l/min]	60	95	140	170	210	310	375	430
Flow rate Kv [m ³ /h]	0.06	0.09	0.13	0.16	0.2	0.3	0.35	0.4
Nominal pressure of fitting PN	100							
Medium	Compressed air to ISO 8573-1:2010 [7:4:4]							
	Inert gases							
	Mineral oil							
	Neutral fluids							
	Water							
	Other flow media on request							
Pressure difference [bar]	0							
Ambient temperature [°C]	-10 ... +35°C							
Temperature of medium [°C]	-10 ... +80°C							
Leak rate to EN 12266-1	A							
Corrosion resistance class CRC ¹⁾	3							

1) Corrosion resistance class CRC 3 to Festo standard FN 940070

High corrosion stress. Outdoor exposure under moderate corrosive conditions. Externally visible parts with primarily functional surface requirements which are in direct contact with a normal industrial environment.

Data sheet – Stainless steel housing, nominal pressure PN 100

Electrical data			
Operating voltage		24 V DC	110 V AC 230 V AC
Electrical connection	Plug to EN 175301-803 type A, square design		
CE marking		–	73/23/EEC 73/23/EEC
Insulation class		H	F F
Duty cycle	[%]	100	
Permissible voltage fluctuations	[%]	±10	
Switching time on	[ms]	20	
Switching time off	[ms]	18	
Characteristic coil data			
Direct current DC	[V]	24	– –
Alternating current AC	[V]	–	110 230
Power consumption, solenoid coil type	VACS-H0P	[W]	6.8 – –
	VACS-H1P	[W]	11 – –
Pick-up power, solenoid coil type	VACS-H0P	[VA]	– 10.5 10.5
	VACS-H1P	[VA]	– 19 18
Holding power, solenoid coil type	VACS-H0P	[VA]	– 8 7.6
	VACS-H1P	[VA]	– 16 15
	[Hz]	–	50, 60 50, 60
Materials			
Solenoid valves			Material number
Housing	High-alloy stainless steel		1.4305
Seals	FPM		
Note on materials	Contains paint-wetting impairment substances		
	RoHS-compliant		

Data sheet – Stainless steel housing, nominal pressure PN 100

Dimensions

Download CAD data → www.festo.com

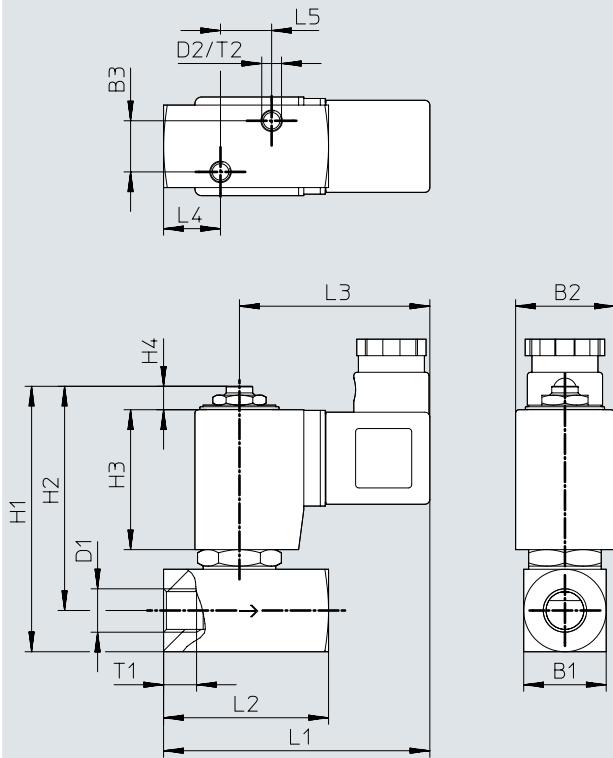

Type	B1	B2	B3	D1	D2	H1	H2	H3	H4	L1	L2	L3	L4	L5	T1	T2
VZWD-...-G 1/8-50-...-5	25	30	15.5	G1/8	M6	81	68	42.5	7	78	40	58	12	15.5	8	6
VZWD-...-G 1/8-60-...-4																
VZWD-...-G 1/4-50-...-5	25	30	15.5	G1/4	M6	81	68	42.5	7	85	50	58	17	15.5	10	6
VZWD-...-G 1/4-60-...-4																

Data sheet – Stainless steel housing, nominal pressure PN 100

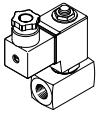
Ordering data							
	Valve body connection	Nominal width	Pressure of medium ¹⁾	Product weight	Operating voltage	Stainless steel casting housing	
		DN	[bar]	[g]		Part no.	Type
	G1/4	1	0 ... 90	650	24 V DC	1491856	VZWD-L-M22C-M-G14-10-V-1P4-90-R1
					110 V AC	1491934	VZWD-L-M22C-M-G14-10-V-2AP4-90-R1
					230 V AC	1492012	VZWD-L-M22C-M-G14-10-V-3AP4-90-R1
		1.5	0 ... 85	650	24 V DC	1491857	VZWD-L-M22C-M-G14-15-V-1P4-85-R1
					110 V AC	1491935	VZWD-L-M22C-M-G14-15-V-2AP4-85-R1
					230 V AC	1492013	VZWD-L-M22C-M-G14-15-V-3AP4-85-R1
		2	0 ... 40	650	24 V DC	1491858	VZWD-L-M22C-M-G14-20-V-1P4-40-R1
					110 V AC	1491936	VZWD-L-M22C-M-G14-20-V-2AP4-40-R1
					230 V AC	1492014	VZWD-L-M22C-M-G14-20-V-3AP4-40-R1
		2.5	0 ... 22	650	24 V DC	1491859	VZWD-L-M22C-M-G14-25-V-1P4-22-R1
					110 V AC	1491937	VZWD-L-M22C-M-G14-25-V-2AP4-22-R1
					230 V AC	1492015	VZWD-L-M22C-M-G14-25-V-3AP4-22-R1
		3	0 ... 15	650	24 V DC	1491860	VZWD-L-M22C-M-G14-30-V-1P4-15-R1
					110 V AC	1491938	VZWD-L-M22C-M-G14-30-V-2AP4-15-R1
					230 V AC	1492016	VZWD-L-M22C-M-G14-30-V-3AP4-15-R1
		4	0 ... 8	650	24 V DC	1491861	VZWD-L-M22C-M-G14-40-V-1P4-8-R1
					110 V AC	1491939	VZWD-L-M22C-M-G14-40-V-2AP4-8-R1
					230 V AC	1492017	VZWD-L-M22C-M-G14-40-V-3AP4-8-R1
		5	0 ... 5	650	24 V DC	1491862	VZWD-L-M22C-M-G14-50-V-1P4-5-R1
					110 V AC	1491940	VZWD-L-M22C-M-G14-50-V-2AP4-5-R1
					230 V AC	1492018	VZWD-L-M22C-M-G14-50-V-3AP4-5-R1
		6	0 ... 4	650	24 V DC	1491863	VZWD-L-M22C-M-G14-60-V-1P4-4-R1
					110 V AC	1491941	VZWD-L-M22C-M-G14-60-V-2AP4-4-R1
					230 V AC	1492019	VZWD-L-M22C-M-G14-60-V-3AP4-4-R1

1) The valves are suitable for vacuum with Pabs > 100 mbar. Please ensure the flow direction corresponds to the direction of the arrow.

Data sheet – Stainless steel housing, nominal pressure PN 100

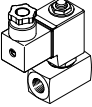
Ordering data	Valve body connection	Nominal width DN	Pressure of medium ¹⁾ [bar]	Product weight [g]	Operating voltage	Stainless steel casting housing	
						Part no.	Type
	G1/8	1	0 ... 90	500	24 V DC	1491848	VZWD-L-M22C-M-G18-10-V-1P4-90-R1
					110 V AC	1491926	VZWD-L-M22C-M-G18-10-V-2AP4-90-R1
					230 V AC	1492004	VZWD-L-M22C-M-G18-10-V-3AP4-90-R1
		1.5	0 ... 85	500	24 V DC	1491849	VZWD-L-M22C-M-G18-15-V-1P4-85-R1
					110 V AC	1491927	VZWD-L-M22C-M-G18-15-V-2AP4-85-R1
					230 V AC	1492005	VZWD-L-M22C-M-G18-15-V-3AP4-85-R1
		2	0 ... 40	500	24 V DC	1491850	VZWD-L-M22C-M-G18-20-V-1P4-40-R1
					110 V AC	1491928	VZWD-L-M22C-M-G18-20-V-2AP4-40-R1
					230 V AC	1492006	VZWD-L-M22C-M-G18-20-V-3AP4-40-R1
		2.5	0 ... 22	500	24 V DC	1491851	VZWD-L-M22C-M-G18-25-V-1P4-22-R1
					110 V AC	1491929	VZWD-L-M22C-M-G18-25-V-2AP4-22-R1
					230 V AC	1492007	VZWD-L-M22C-M-G18-25-V-3AP4-22-R1
		3	0 ... 15	500	24 V DC	1491852	VZWD-L-M22C-M-G18-30-V-1P4-15-R1
					110 V AC	1491930	VZWD-L-M22C-M-G18-30-V-2AP4-15-R1
					230 V AC	1492008	VZWD-L-M22C-M-G18-30-V-3AP4-15-R1
		4	0 ... 8	500	24 V DC	1491853	VZWD-L-M22C-M-G18-40-V-1P4-8-R1
					110 V AC	1491931	VZWD-L-M22C-M-G18-40-V-2AP4-8-R1
					230 V AC	1492009	VZWD-L-M22C-M-G18-40-V-3AP4-8-R1
		5	0 ... 5	500	24 V DC	1491854	VZWD-L-M22C-M-G18-50-V-1P4-5-R1
					110 V AC	1491932	VZWD-L-M22C-M-G18-50-V-2AP4-5-R1
					230 V AC	1492010	VZWD-L-M22C-M-G18-50-V-3AP4-5-R1
		6	0 ... 4	500	24 V DC	1491855	VZWD-L-M22C-M-G18-60-V-1P4-4-R1
					110 V AC	1491933	VZWD-L-M22C-M-G18-60-V-2AP4-4-R1
					230 V AC	1492011	VZWD-L-M22C-M-G18-60-V-3AP4-4-R1

1) The valves are suitable for vacuum with Pabs > 100 mbar. Please ensure the flow direction corresponds to the direction of the arrow.