

M12 Connectivity Solutions



M12 PVC Cordsets

Cable: PVC jacket, PUR (polyurethane) connector body, nickel-plated brass coupling nut

Vibration Shock: Meets IEC 60068-2-6 requirements

Mechanical Shock: Meets IEC 60068-2-27 requirements

Temperature: -40° to +70° C

Environmental Rating: IP66, IP67, IP68, NEMA 1, UL Type 1

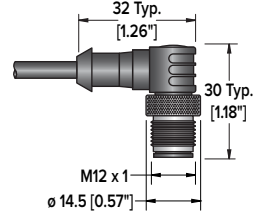
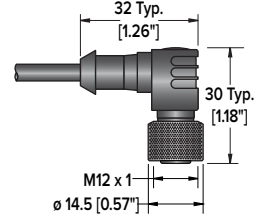
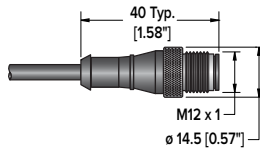
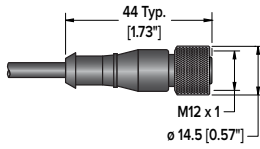

4-Pin (Voltage: 250 V dc/ac, Current: 4 A)



	Length	Straight	Right-Angle		Pinout
4-Pin Female QD to Flying Leads	1 m	MQDC-403	—		1 = Brown 2 = White 3 = Blue 4 = Black
	2 m	MQDC-406	MQDC-406RA		
	3 m	MQDC-410	—		
	5 m	MQDC-415	MQDC-415RA		
	9 m	MQDC-430	MQDC-430RA		
	15 m	MQDC-450	MQDC-450RA		
	18 m	MQDC-460	MQDC-460RA		
	21 m	MQDC-470	MQDC-470RA		
	30 m	MQDC-4100	MQDC-4100RA		
				22 AWG	Cable ϕ – 5.2 mm



4-Pin Male QD to Flying Leads	2 m	MQDMC-406	MQDMC-406RA		1 = Brown 2 = White 3 = Blue 4 = Black
	5 m	MQDMC-415	MQDMC-415RA		
	9 m	MQDMC-430	MQDMC-430RA		
				22 AWG	Cable ϕ – 5.2 mm



	Length	Straight/Straight (female/male)	Straight/Right-Angle (female/male)		Pinout
4-Pin Double-Ended	0.3 m	MQDEC-401SS	MQDEC-401RS		1 = Brown 2 = White 3 = Blue 4 = Black
	0.6 m	MQDEC-402SS	—		
	0.9 m	MQDEC-403SS	MQDEC-403RS		
	1.8 m	MQDEC-406SS	MQDEC-406RS		
	3.0 m	MQDEC-410SS	—		
	3.6 m	MQDEC-412SS	MQDEC-412RS		
	4.5 m	MQDEC-415SS	—		
	6.1 m	MQDEC-420SS	MQDEC-420RS		
	9.2 m	MQDEC-430SS	MQDEC-430RS		
	15.2 m	MQDEC-450SS	MQDEC-450RS		
				22 AWG	Cable ϕ – 5.2 mm



	Length	Straight	Right-Angle		Pinout
4-Pin Female QD to Flying Leads Open Shield with Drain Wire	2 m	MQDEC2-406	MQDEC2-406RA		1 = Brown 2 = White 3 = Blue 4 = Black
	5 m	MQDEC2-415	MQDEC2-415RA		
	9 m	MQDEC2-430	MQDEC2-430RA		
	15 m	MQDEC2-450	MQDEC2-450RA		
				22 AWG	Cable ϕ – 5.2 mm

*Not all models are shown. Please contact Banner for other available lengths and double-ended styles.

M12 PVC Cordsets

5-Pin (Voltage: 60 V dc/ac, Current: 4 A)

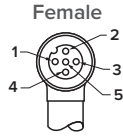

	Length	Straight	Right-Angle		Pinout
5-Pin Female QD to Flying Leads	0.9 m	MQDC1-503	—		1 = Brown 2 = White 3 = Blue 4 = Black 5 = Gray
	2 m	MQDC1-506	MQDC1-506RA		
	5 m	MQDC1-515	MQDC1-515RA		
	9 m	MQDC1-530	MQDC1-530RA		
	18 m	MQDC1-560	—		
	30 m	MQDC1-5100	—		
				22 AWG	Cable ø – 5.6 mm

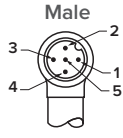

5-Pin Male QD to Flying Leads	2 m	MQDMC-506	MQDMC-506RA		1 = Brown 2 = White 3 = Blue 4 = Black 5 = Gray
	5 m	MQDMC-515	MQDMC-515RA		
	9 m	MQDMC-530	MQDMC-530RA		
				22 AWG	Cable ø – 5.6 mm

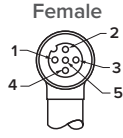

	Length	Straight/Straight (female/male)	Straight/Right-Angle		Pinout
5-Pin Double-Ended	0.3 m	MQDEC-501SS	—		1 = Brown 2 = White 3 = Blue 4 = Black 5 = Gray
	1 m	MQDEC-503SS	—		
	2 m	MQDEC-506SS	—		
	5 m	MQDEC-515SS	—		
	9 m	MQDEC-530SS	—		
	15 m	MQDEC-550SS	—		
				22 AWG	Cable ø – 5.6 mm

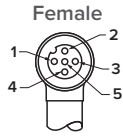

	Length	Straight	Right-Angle		Pinout
5-Pin Female QD to Flying Leads Open Shield with Drain Wire	2 m	MQDEC2-506	MQDEC2-506RA		1 = Brown 2 = White 3 = Blue 4 = Black 5 = Gray
	5 m	MQDEC2-515	MQDEC2-515RA		
	9 m	MQDEC2-530	MQDEC2-530RA		
	15 m	MQDEC2-550	MQDEC2-550RA		
	23 m	MQDEC2-575	MQDEC2-575RA		
	30 m	MQDEC2-5100	MQDEC2-5100RA		
				22 AWG	Cable ø – 5.7 mm

*Not all models are shown. Please contact Banner for other available lengths and double-ended styles.

M12 PVC Cordsets

8-Pin (Voltage: 30 V dc/ac, Current: 2 A)

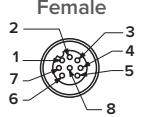

	Length	Straight	Right-Angle		Pinout
8-Pin Female to Flying Leads	2 m	MQDC1-806	MQDC1-806RA	 <p>Female</p>	1 = White 5 = Gray 2 = Brown 6 = Pink 3 = Green 7 = Blue 4 = Yellow 8 = Red
	5 m	MQDC1-815	MQDC1-815RA		
	9 m	MQDC1-830	MQDC1-830RA		
	15 m	MQDC1-850	MQDC1-850RA		
	30 m	MQDC1-8100	—		
				24 AWG	Cable ø – 5.9 mm

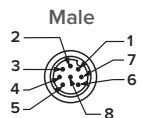

8-Pin Male to Flying Leads	2 m	MQDMC1-806	—	 <p>Male</p>	1 = White 5 = Gray 2 = Brown 6 = Pink 3 = Green 7 = Blue 4 = Yellow 8 = Red
	5 m	MQDMC1-815	—		
	9 m	MQDMC1-830	—		
	15 m	MQDMC1-850	—		
				24 AWG	Cable ø – 5.9 mm

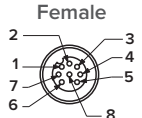

	Length	Straight/Straight (female/male)	Right-Angle/Straight		Pinout
8-Pin Double-Ended	1 m	MQDEC1-803SS	—	 <p>Female</p>	1 = White 5 = Gray 2 = Brown 6 = Pink 3 = Green 7 = Blue 4 = Yellow 8 = Red
	2 m	MQDEC1-806SS	—		
	5 m	MQDEC1-815SS	—		
	9 m	MQDEC1-830SS	—		
	15 m	MQDEC1-850SS	—		
	30 m	MQDEC1-8100SS	—		
				24 AWG	Cable ø – 5.9 mm

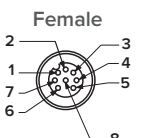

	Length	Straight	Right-Angle		Pinout
8-Pin Female QD to Flying Leads Open Shield with Drain Wire	2 m	MQDC2S-806	MQDC2S-806RA	 <p>Female</p>	1 = White 5 = Gray 2 = Brown 6 = Pink 3 = Green 7 = Blue 4 = Yellow 8 = Red
	5 m	MQDC2S-815	MQDC2S-815RA		
	10 m	MQDC2S-830	MQDC2S-830RA		
	16 m	MQDC2S-850	MQDC2S-850RA		
	31 m	MQDC2S-8100	—		
				24 AWG	Cable ø – 5.6 mm

*Not all models are shown. Please contact Banner for other available lengths and double-ended styles.

M12 PVC Cordsets

12-Pin (Voltage: 30 V dc/ac, Current: 2 A)



	Length	Straight	Right-Angle		Pinout	
12-Pin Female to Flying Leads	2 m	MQDC-1206	—	<p>Female</p>	1 = White	7 = Blue
	3 m	MQDC-1210	—		2 = Brown	8 = Red
	5 m	MQDC-1215	—		3 = Green	9 = Orange
	9 m	MQDC-1230	—		4 = Yellow	10 = Tan
				24 AWG	5 = Gray	11 = Black
					6 = Pink	12 = Violet
					Cable \varnothing – 6.35 mm	

M12 PUR Cordsets

Cable: PUR jacket, PUR (polyurethane) connector body, nickel-plated brass coupling nut

Vibration Shock: Meets IEC 60068-2-6 requirements

Mechanical Shock: Meets IEC 60068-2-27 requirements

Temperature: -40° to +70° C

Environmental Rating: IP66, IP67, IP68, NEMA 1, UL Type 1

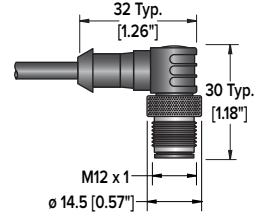
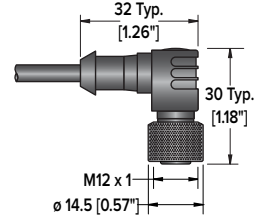
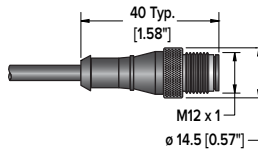
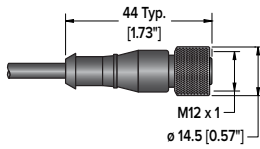

4-Pin (Voltage: 250 V dc/ac, Current: 4 A)



	Length	Straight	Right-Angle		Pinout
4-Pin Female QD to Flying Leads	2 m	MQDC-406-PUR	MQDC-406RA-PUR	<p>Female 22 AWG</p>	1 = Brown 2 = White 3 = Blue 4 = Black Cable ø – 4.1 mm
	5 m	MQDC-415-PUR	MQDC-415RA-PUR		
	10 m	MQDC-430-PUR	MQDC-430RA-PUR		



	Length	Straight/Straight (female/male)	Right-Angle/Straight (female/male)		Pinout
4-Pin Double-Ended	0.3 m	MQDEC-401SS-PUR	MQDEC-401SR-PUR	<p>Female</p>	1 = Brown 2 = White 3 = Blue 4 = Black Cable ø – 4.1 mm
	0.6 m	MQDEC-402SS-PUR	MQDEC-402SR-PUR		
	1 m	MQDEC-403SS-PUR	MQDEC-403SR-PUR		
	2 m	MQDEC-406SS-PUR	MQDEC-406SR-PUR	<p>Male</p>	
	3 m	MQDEC-409SS-PUR	MQDEC-409SR-PUR		
	5 m	MQDEC-415SS-PUR	MQDEC-415SR-PUR		
	10 m	MQDEC-430SS-PUR	MQDEC-430SR-PUR		

*Not all models are shown. Please contact Banner for other available lengths and double-ended styles.

M12 Specialty Cordsets

Lighted Cordsets

Cable: PVC jacket, translucent white PVC connector body, nickel-plated brass coupling nut

Vibration Shock: Meets IEC 60068-2-6 requirements

Mechanical Shock: Meets IEC 60068-2-27 requirements

Temperature: Max current of 1.0 A: -40 to +60 °C
 Max current of 2.0 A: -40 to +55 °C
 Max current of 4.0 A: -40 to +45 °C

Environmental Rating: IP66, IP67, IP68, NEMA 1, UL Type 1

LED Operation: Green LED indicates power ON; Yellow LED overrides green LED when pin 4 is active

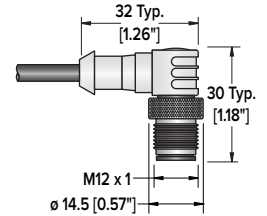
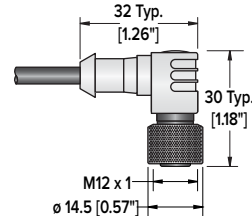
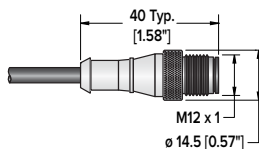
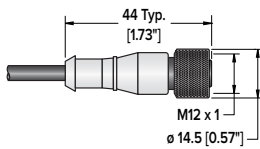

4-Pin (Voltage: 10 V dc to 30 V dc at 15 mA max)



	Length	Straight	Right-Angle		Pinout
4-Pin PNP	2 m	MQDC-406-GYP	MQDC-406-GYPRA	 22 AWG	1 = Brown 2 = White 3 = Blue 4 = Black (ouput LED) Cable ø – 5.2 mm
	5 m	MQDC-415-GYP	MQDC-415-GYPRA		
	9 m	MQDC-430-GYP	MQDC-430-GYPRA		
4-Pin NPN	2 m	MQDC-406-GYN	MQDC-406-GYNRA	 22 AWG	1 = Brown 2 = White 3 = Blue 4 = Black (ouput LED) Cable ø – 5.2 mm
	5 m	MQDC-415-GYN	MQDC-415-GYNRA		
	9 m	MQDC-430-GYN	MQDC-430-GYNRA		

5-Pin (Voltage: 10 V dc to 30 V dc at 15 mA max)



	Length	Straight	Right-Angle		Pinout
5-Pin PNP	2 m	MQDC-506-GYP	MQDC-506-GYPRA	 22 AWG	1 = Brown 2 = White 3 = Blue 4 = Black (ouput LED) 5 = Gray Cable ø – 5.6 mm
	5 m	MQDC-515-GYP	MQDC-515-GYPRA		
	9 m	MQDC-530-GYP	MQDC-530-GYPRA		
5-Pin NPN	2 m	MQDC-506-GYN	MQDC-506-GYNRA	 22 AWG	1 = Brown 2 = White 3 = Blue 4 = Black (ouput LED) 5 = Gray Cable ø – 5.6 mm
	5 m	MQDC-515-GYN	MQDC-515-GYNRA		
	9 m	MQDC-530-GYN	MQDC-530-GYNRA		

M12 Specialty Cordsets

Coiled Cordsets

Cable: PUR jacket, black PUR connector body, nickel-plated brass coupling nut

Vibration Shock: Meets IEC 60068-2-6 requirements

Mechanical Shock: Meets IEC 60068-2-27 requirements

Temperature: -40° to +70° C

Environmental Rating: IP67, IP69K, NEMA 1, 3, 4, 6P, 13

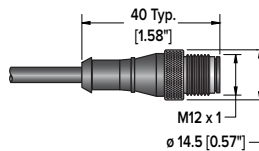
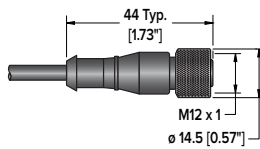

4-Pin (Voltage: 250 V dc/ac, Current: 4 A)



	Length (retracted to extended)	Straight	Pinout
4-Pin	0.8 to 1.7 m	MQDC-401.7M-PUR-C	<p>Female</p> <p>1 = Brown 2 = White 3 = Blue 4 = Black</p> <p>22 AWG Cable ø – 5.2 mm</p>
	1.0 to 2.6 m	MQDC-402.6M-PUR-C	
	1.2 to 3.3 m	MQDC-403.3M-PUR-C	



	Length (retracted to extended)	Straight/Straight	Pinout
4-Pin Double-Ended Cordsets	0.8 to 1.7 m	MQDEC-401.7M-PUR-C	<p>Female</p> <p>1 = Brown 2 = White 3 = Blue 4 = Black</p> <p>22 AWG Cable ø – 5.2 mm</p>
	1.0 to 2.6 m	MQDEC-403.3M-PUR-C	

M12 Specialty Cordsets

High Pressure and Temperature Washdown Cordsets

Cable: PVC jacket, 316 stainless steel nut

Vibration Shock: Meets IEC 60068-2-6 requirements

Mechanical Shock: Meets IEC 60068-2-27 requirements

Temperature: -40 to +70 °C

Environmental Rating: IP66, IP67, IP68, IP69K, NEMA 1, UL Type 1

Certifications: **ECOLAB** test F and E Nr. 40-1

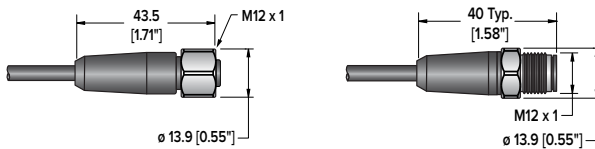

4-Pin (Voltage: 250 V dc/ac, Current: 4 A)



	Length	Straight	Pinout
4-Pin	2 m	MQDC-WDSS-0406	
	5 m	MQDC-WDSS-0415	
	9 m	MQDC-WDSS-0430	



	Length	Straight/Straight	Pinout
4-Pin Double-Ended	0.31 m	MQDEC-WDSS-401SS	
	0.91 m	MQDEC-WDSS-403SS	
	1.83 m	MQDEC-WDSS-406SS	
	3.7 m	MQDEC-WDSS-412SS	

5-Pin (Voltage: 60 V dc/ac, Current: 4 A)



	Length	Straight	Pinout
5-Pin	2 m	MQDC-WDSS-0506	
	5 m	MQDC-WDSS-0515	
	9 m	MQDC-WDSS-0530	



	Length	Straight/Straight	Pinout
5-Pin Double-Ended	1.5 m	MQDEC-WDSS-505SS	
	3 m	MQDEC-WDSS-510SS	
	4.57 m	MQDEC-WDSS-515SS	

M12 Specialty Cordsets

Chemical Washdown Cordsets

Cable: White polypropylene jacket, polypropylene connector body, polypropylene contact carriers, 316 stainless steel nut

Vibration Shock: Meets IEC 60068-2-6 requirements

Mechanical Shock: Meets IEC 60068-2-27 requirements

Temperature: -40 °C to +90 °C

Environmental Rating: IP68, NEMA 1, 3, 4, 6P

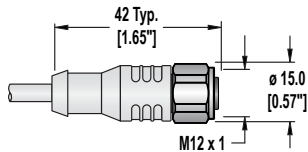

5-Pin (Voltage: 250 V dc/ac, Current: 4 A)



	Length	Straight	Pinout
5-Pin Female QD to Flying Leads Open Shield with Drain Wire	2 m	MQDCWD-506	<p>Female</p> <p>1 = Brown 2 = White 3 = Blue 4 = Black 5 = Gray</p> <p>22 AWG Cable ϕ – 4.5 mm</p>
	9 m	MQDCWD-530	

Namur

Cable: Blue PVC jacket, PUR connector body, nickel-plated brass coupling nut

Vibration Shock: Meets IEC 60068-2-6 requirements

Mechanical Shock: Meets IEC 60068-2-27 requirements

Temperature: -40 °C to +105 °C

Environmental Rating: IP67, NEMA 1, 3, 4, 6P, 13

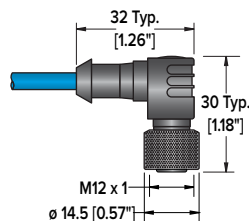
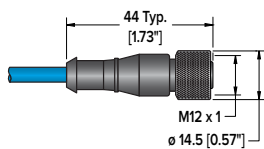

4-Pin (Voltage: 250 V dc/ac, Current: 4 A)



	Length	Straight	Right-Angle	Pinout
4-Pin	2 m	MQD9-406	MQD9-406RA	<p>Female</p> <p>1 = Brown 2 = Blue</p> <p>20 AWG Cable ϕ – 5.2 mm</p>
	5 m	MQD9-415	MQD9-415RA	
	9 m	MQD9-430	MQDC-430RA	

M12 Splitters, Combiners, and Tees

Round QD Splitters

Cable: PVC jacket, PUR (polyurethane) connector body, nickel-plated brass coupling nut

Temperature: -40 to +90 °C

Environmental Rating: IP68

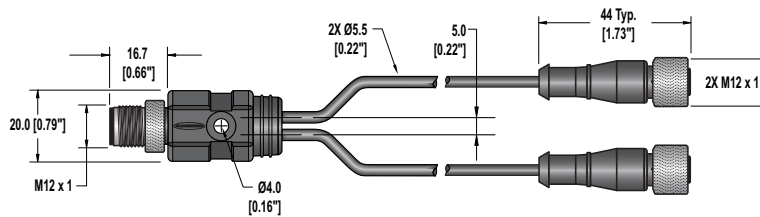

Example of Parallel 4-Pin Wiring

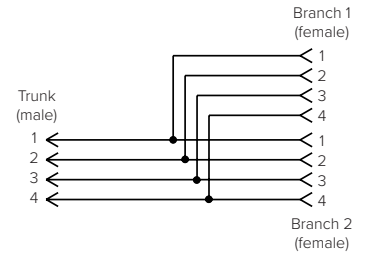

4-Pin (Voltage: 60 V dc/ac, Current: 2 A)



	Models	Cable Lengths		Pinout
		Trunk (Male)	Branches (Female)	
4-Pin	CSRB-M1240M1241	No Trunk/ Integral QD	0.3 m	Female 1 = Brown 2 = White 3 = Blue 4 = Black Male 4 x 22 AWG Cable ø – 5.5 mm
	CSRB-M1240M1242		0.6 m	
	CSRB-M1240M1243		0.9 m	
	CSRB-M1240M1244		1.2 m	

5-Pin (Voltage: 60 V dc/ac, Current: 2 A)



	Models	Cable Lengths		Pinout
		Trunk (Male)	Branches (Female)	
5-Pin	CSRB-M1250M125.47M125.73	No Trunk/ Integral QD	Branch 1 0.14 m Branch 2 0.22 m	Female 1 = Brown 2 = White 3 = Blue 4 = Black 5 = Gn/Ye Male 5 x 22 AWG Cable ø – 5.5 mm

M12 Splitters, Combiners, and Tees

Compact Flat QD Splitters and Tees

Cable: PVC jacket, PUR (polyurethane) connector body, nickel-plated brass coupling nut

Temperature: -40 to +90 °C

Environmental Rating: IP68

Example of Parallel 4-Pin Wiring

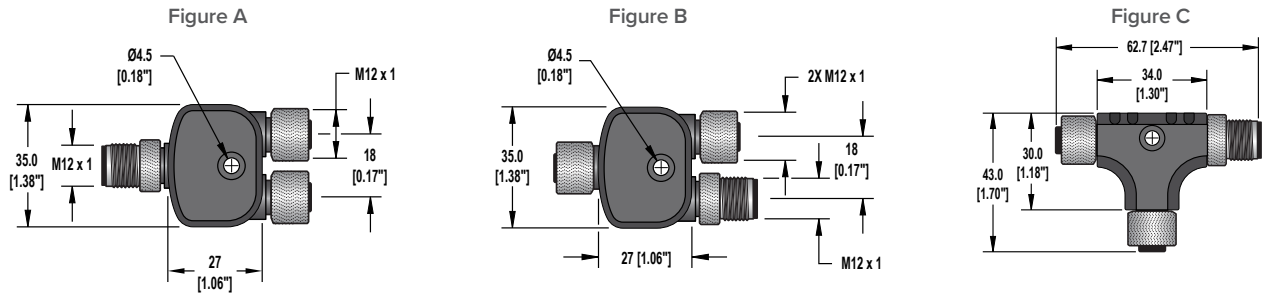
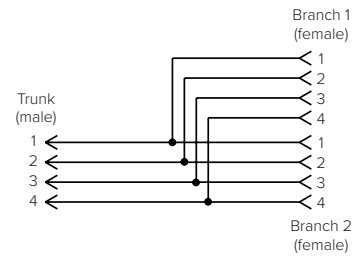

4-Pin (Voltage: 250 V dc/ac, Current: 4 A)



Models	Dimensional Drawing	Pinout
4-Pin CSB-M1240M1240	Figure A	<p>Female</p> <p>1 = Brown 2 = White 3 = Blue 4 = Black</p> <p>Male</p> <p>22 AWG Cable ø – 6.0 mm</p>

5-Pin (Voltage: 30 V dc/ac, Current: 2 A)



Models	Dimensional Drawing	Pinout
5-Pin CSB-M1250M1250-T	Figure C	<p>Female</p> <p>1 = Brown 2 = White 3 = Blue 4 = Black 5 = Gray</p> <p>Male</p> <p>22 AWG Cable ø – 5.5 mm</p>
5-Pin CSB-M1250M1250A	Figure A	
5-Pin CSB-M1250M1250	Figure B	

8-Pin (Voltage: 60 V dc/ac, Current: 2 A)



Models	Dimensional Drawing	Pinout
8-Pin CSB-M1280M1280	Figure A	<p>Female</p> <p>1 = Brown 2 = Or/Bk 3 = Orange 4 = White 5 = Black 6 = Blue 7 = Gr/Ye 8 = Violet</p> <p>Male</p> <p>22 AWG Cable ø – 6.0 mm</p>

M12 Splitters, Combiners, and Tees

Flat QD Splitters

Cable: PVC jacket, PUR (polyurethane) connector body, nickel-plated brass coupling nut

Temperature: -40 to +90 °C

Environmental Rating: IP68

Example of Parallel 4-Pin Wiring

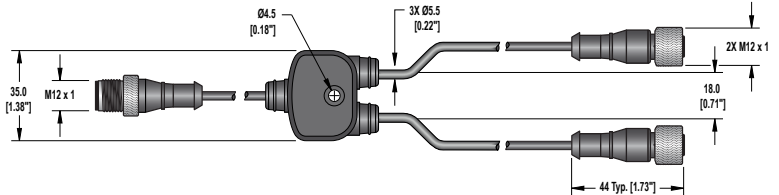
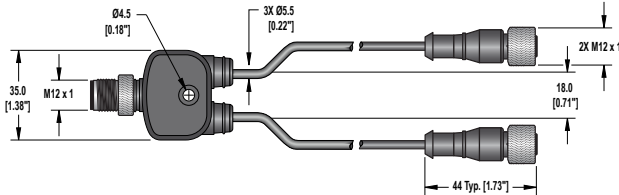
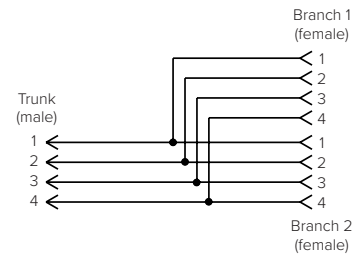

4-Pin (Voltage: 250 V dc/ac, Current: 4 A)



	Models	Cable Lengths		Pinout
		Trunk (Male)	Branches (Female)	
4-Pin	CSB-M1240M1241	No Trunk/Integral QD	2 x 0.3 m	Female 1 = Brown 2 = White 3 = Blue 4 = Black Male 22 AWG Cable ø – 6.0 mm
	CSB-M1241M1241	0.3 m	2 x 0.3 m	
	CSB-M1243M1243	1 m	2 x 1 m	
	CSB-M1248M1241	2.4 m	2 x 0.3 m	
	CSB-M12415M1241	4.6 m	2 x 0.3 m	
	CSB-UNT425M1241	7.6 m Unterminated	2 x 0.3 m	

5-Pin (Voltage: 30 V dc/ac, Current: 2 A)



	Models	Cable Lengths		Pinout
		Trunk	Branches	
5-Pin	CSB-M1251M1251B	0.3 m (Male)	2 x 0.3 m (Female)	Female 1 = Brown 2 = White 3 = Blue 4 = Black 5 = Gray Male 22 AWG Cable ø – 5.9 mm
	CSB-M1251FM1251M	0.3 m (Female)	2 x 0.3 m (Male)	

8-Pin (Voltage: 60 V dc/ac, Current: 2 A)



	Models	Cable Lengths		Pinout
		Trunk (Male)	Branches (Female)	
8-Pin	CSB-M1281M1281B	0.3 m	2 x 0.3 m	Female 1 = Brown 2 = Or/Bk 3 = Orange 4 = White 5 = Black 6 = Blue 7 = Gr/Ye 8 = Violet Male 22 AWG Cable ø – 6.0 mm

Wiring Combiners

Cable: PVC jacket, PUR (polyurethane) connector body, nickel-plated brass coupling nut

Temperature: -40 to +105 °C

Environmental Rating: IP68

Example of 4-Pin Wiring

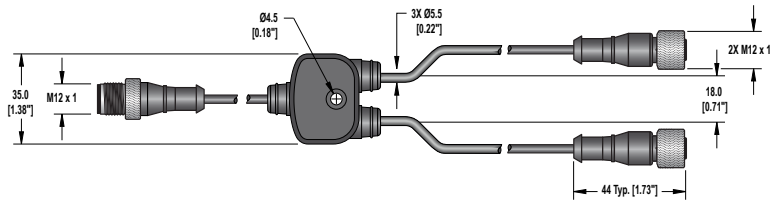
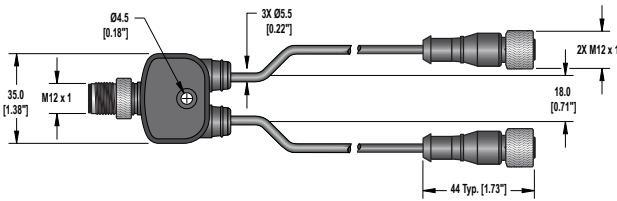
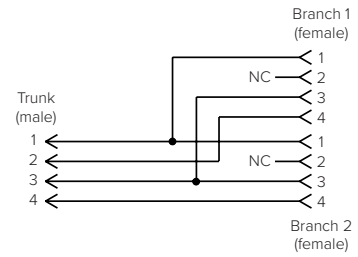

4-Pin (Voltage: 250 V dc/ac, Current: 4 A)

	Models	Cable Lengths		Pinout
		Trunk (Male)	Branches (Female)	
4-Pin	CSA-M1240M1241	No Trunk/ Integral QD	2 x 0.3 m	 1 = Brown 2 = White 3 = Blue 4 = Black
	CSA-M1240M1243	No Trunk/ Integral QD	2 x 1 m	
	CSA-M1240M1246	No Trunk/ Integral QD	2 x 2 m	
	CSA-M1241M1241	0.3 m	2 x 0.3 m	
	CSA-M1243M1243	1 m	2 x 1 m	
	CSA-M1246M1246	2 m	2 x 2 m	
				 22 AWG Cable ø – 6.0 mm



M12 Molded Junction Blocks

Temperature: -40 to +70 °C

Environmental Rating: IP65, IP67, and IP68

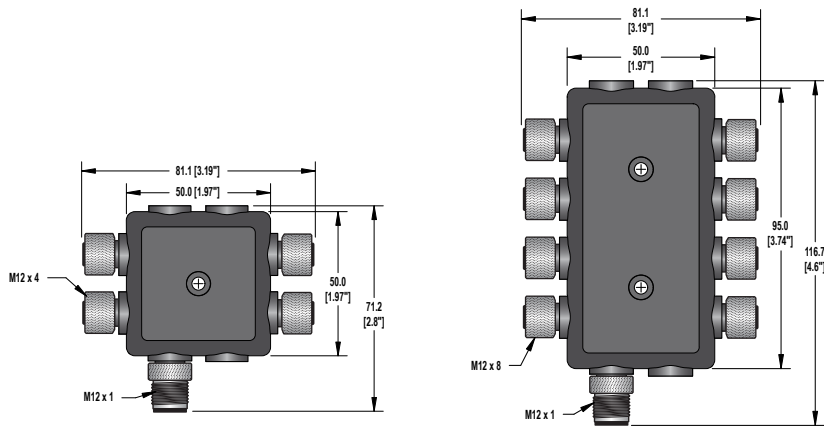

Example of Parallel 5-Pin Wiring
(diagram applies to all branches)

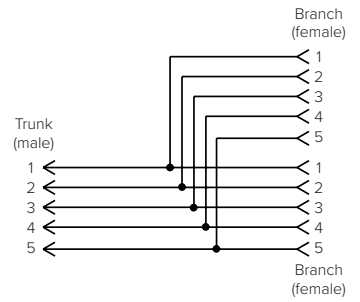

5-Pin (Voltage: 30 V dc/ac, Current: 2 A)



	Models	Cable Lengths		Pinout
		Branches (Female)	Trunk (Male)	
5-Pin	R50-4M125-M125Q-P	4 x No Branch/ Integral QD	No Trunk/Integral QD	<p>Male</p> <p>1 = Brown 2 = White 3 = Blue 4 = Black 5 = Gray</p> <p>Female</p>
	R95-8M125-M125Q-P	8 x No Branch/ Integral QD	No Trunk/Integral QD	

M12 Multi-port Splitters

Cable: PVC jacket, PUR (polyurethane) connector body, nickel-plated brass coupling nut

Temperature: -40° to +90° C

Environmental Rating: IP68

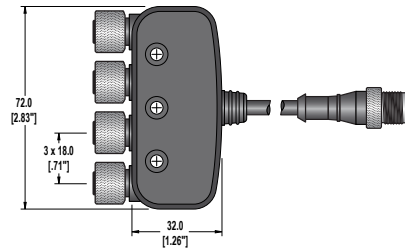

Example of Parallel 5-Pin Wiring (diagram applies to all branches)

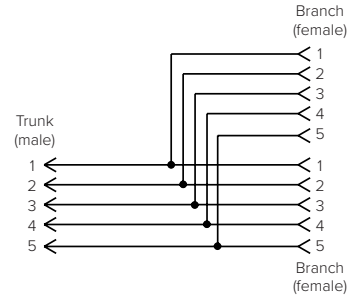

5-Pin (Voltage: 30 V dc/ac, Current: 2 A)



	Models	Cable Lengths		Pinout
		Branches (Female)	Trunk (Male)	
5-Pin	CSB4-M1251M1250	4 x No Branch / Integral QD	0.3 m	<p>Female</p> <p>1 = Brown 2 = White 3 = Blue 4 = Black</p> <p>Male</p> <p>4 x 22 AWG Cable ø – 5.6 mm</p>



Banner Engineering manufactures industrial automation products that include sensors, LED lights and indicators, machine safety components, industrial wireless devices, barcode scanners, vision sensors, industrial networks and smart i/o devices, and connectivity products. These products help produce the cars we drive, the food we eat, the medicine we take, and many of the things we touch every day. Headquartered in Minneapolis since 1966, Banner is an industry leader with over 30,000 active products, operations on six continents, and a global footprint of over 5,500 employees, factory and field representatives, and application engineers. Every 3.5 seconds a Banner product is installed somewhere in the world. From adding new capabilities to our existing products or introducing brand-new IIoT technology for smart manufacturing, Banner is your trusted partner for durable, dependable solutions.



Mouser Electronics

Authorized Distributor

Click to View Pricing, Inventory, Delivery & Lifecycle Information:

[Banner Engineering:](#)

[CSA-M1241M1241](#) [CSB-M1250M1250-T](#) [CSB-M1251FM1251M](#) [CSB-M1251M1251B](#) [CSRB-M1240M1241](#) [CSRB-M1240M1242](#) [CSA-M1240M1246](#) [CSA-M1243M1243](#) [CSA-M1246M1246](#) [CSRB-M1240M1243](#) [CSRB-M1240M1244](#)
[CSB4-M1251M1250](#) [CSB-M1250M1250A](#) [CSA-M1240M1241](#) [CSA-M1240M1243](#)