

FEATURES

- 2 selectable differential inputs**
- Selectable LVDS/CMOS outputs**
- Up to 12 LVDS (1.2 GHz) or 24 CMOS (250 MHz) outputs**
- <12 mW per channel (100 MHz operation)**
- 54 fs rms integrated jitter (12 kHz to 20 MHz)**
- 100 fs rms additive broadband jitter**
- 2.0 ns propagation delay (LVDS)**
- 135 ps output rise/fall (LVDS)**
- 70 ps output-to-output skew (LVDS)**
- Sleep mode**
- Pin programmable control**
- 1.8 V power supply**

APPLICATIONS

- Low jitter clock distribution**
- Clock and data signal restoration**
- Level translation**
- Wireless communications**
- Wired communications**
- Medical and industrial imaging**
- ATE and high performance instrumentation**

GENERAL DESCRIPTION

The ADCLK854 is a 1.2 GHz/250 MHz LVDS/CMOS fanout buffer optimized for low jitter and low power operation. Possible configurations range from 12 LVDS to 24 CMOS outputs, including combinations of LVDS and CMOS outputs. Three control lines are used to determine whether fixed blocks of outputs (three banks of four) are LVDS or CMOS outputs.

The ADCLK854 offers two selectable inputs and a sleep mode feature. The IN_SEL pin state determines which input is fanned out to all the outputs. The SLEEP pin enables a sleep mode to power down the device.

The inputs accept various types of single-ended and differential logic levels including LVPECL, LVDS, HSTL, CML, and CMOS. Table 8 provides interface options for each type of connection.

This device is available in a 48-pin LFCSP package. It is specified for operation over the standard industrial temperature range of -40°C to +85°C.

FUNCTIONAL BLOCK DIAGRAM

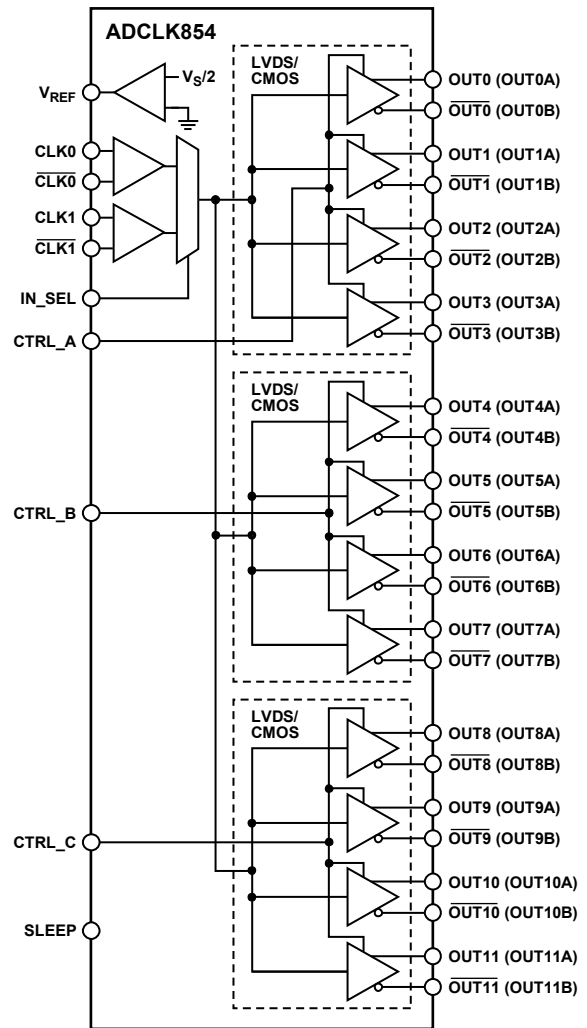

Figure 1.

Rev. A

Information furnished by Analog Devices is believed to be accurate and reliable. However, no responsibility is assumed by Analog Devices for its use, nor for any infringements of patents or other rights of third parties that may result from its use. Specifications subject to change without notice. No license is granted by implication or otherwise under any patent or patent rights of Analog Devices. Trademarks and registered trademarks are the property of their respective owners.

TABLE OF CONTENTS

Features	1	Typical Performance Characteristics	9
Applications	1	Functional Description.....	12
General Description	1	Clock Inputs.....	12
Functional Block Diagram	1	AC-Coupled Input Applications	12
Revision History	2	Clock Outputs.....	12
Specifications	3	Control and Function Pins	13
Electrical Characteristics	3	Power Supply	13
Timing Characteristics	4	Applications Information	14
Clock Characteristics	5	Using the ADCLK854 Outputs for ADC Clock Applications	14
Logic and Power Characteristics.....	5	14
Absolute Maximum Ratings	6	LVDS Clock Distribution.....	14
Determining Junction Temperature.....	6	CMOS Clock Distribution	14
ESD Caution.....	6	Input Termination Options.....	15
Thermal Performance.....	6	Outline Dimensions.....	16
Pin Configuration and Function Descriptions	7	Ordering Guide	16

REVISION HISTORY

11/2020—Rev. 0 to Rev. A

Changed CP-48-6 to CP-48-21.....	Throughout
Changes to Figure 2.....	7
Updated Outline Dimensions.....	16
Changes to Ordering Guide.....	16

4/2009—Revision 0: Initial Version

SPECIFICATIONS

ELECTRICAL CHARACTERISTICS

Typical (Typ) values are given for $V_S = 1.8\text{ V}$ and $T_A = 25^\circ\text{C}$, unless otherwise noted. Minimum (Min) and maximum (Max) values are given over the full $V_S = 1.8\text{ V} \pm 5\%$ and $T_A = -40^\circ\text{C}$ to $+85^\circ\text{C}$ variation, unless otherwise noted. Input slew rate $> 1\text{ V/ns}$, unless otherwise noted.

Table 1. Clock Inputs and Outputs

Parameter	Symbol	Min	Typ	Max	Unit	Conditions
CLOCK INPUTS						
Input Frequency		0		1200	MHz	Differential input
Input Sensitivity, Differential			150		mV p-p	Jitter performance improves with higher slew rates (greater voltage swing)
Input Level				1.8	V p-p	Larger voltage swings can turn on the protection diodes and degrade jitter performance
Input Common-Mode Voltage	V_{CM}	$V_S/2 - 0.1$		$V_S/2 + 0.5$	V	Inputs are self-biased; enables ac coupling
Input Common-Mode Range	V_{CMR}	0.4		$V_S - 0.4$	V	Inputs dc-coupled with 200 mV p-p signal applied
Input Voltage Offset			30		mV	
Input Sensitivity, Single-Ended			150		mV p-p	CLKx ac-coupled; $\overline{\text{CLKx}}$ ac bypassed to ground
Input Resistance (Differential)			7		k Ω	
Input Capacitance	C_{IN}		2		pF	
Input Bias Current (Each Pin)		-350		+350	μA	Full input swing
LVDS CLOCK OUTPUTS						
Output Frequency				1200	MHz	Termination = 100 Ω ; differential (OUTx , $\overline{\text{OUTx}}$)
Output Voltage Differential	V_{OD}	247	344	454	mV	See Figure 9 for swing vs. frequency
Delta V_{OD}	ΔV_{OD}			50	mV	
Offset Voltage	V_{OS}	1.125	1.25	1.375	V	
Delta V_{OS}	ΔV_{OS}			50	mV	
Short-Circuit Current	I_{SA}, I_{SB}		3	6	mA	Each pin (output shorted to GND)
CMOS CLOCK OUTPUTS						
Output Frequency				250	MHz	Single-ended; termination = open; OUTx and $\overline{\text{OUTx}}$ in phase
Output Voltage High	V_{OH}	$V_S - 0.1$			V	With 10 pF load per output; see Figure 16 for swing vs. frequency
Output Voltage Low	V_{OL}			0.1	V	@ 1 mA load
Output Voltage High	V_{OH}	$V_S - 0.35$			V	@ 10 mA load
Output Voltage Low	V_{OL}			0.35	V	@ 10 mA load
Reference Voltage	V_{REF}					
Output Voltage		$V_S/2 - 0.1$	$V_S/2$	$V_S/2 + 0.1$	V	$\pm 500\ \mu\text{A}$
Output Resistance			60		Ω	
Output Current				500	μA	

ADCLK854

TIMING CHARACTERISTICS

Table 2. Timing Characteristics

Parameter	Symbol	Min	Typ	Max	Unit	Conditions
LVDS OUTPUTS						
Output Rise/Fall Time	t_R, t_F		135	235	ps	Termination = 100 Ω differential; 3.5 mA 20% to 80% measured differentially $V_{ICM} = V_{REF}, V_{ID} = 0.5$ V
Propagation Delay, Clock-to-LVDS Output	t_{PD}	1.5	2.0	2.7	ns	
Temperature Coefficient			2.0		ps/ $^{\circ}$ C	
Output Skew ¹						
LVDS Outputs in the Same Bank				50	ps	
All LVDS Outputs						
On the Same Part				65	ps	
Across Multiple Parts				390	ps	
Additive Time Jitter						
Integrated Random Jitter			54		fs rms	
			74		fs rms	BW = 50 kHz to 80 MHz; clock = 1000 MHz
			86		fs rms	BW = 10Hz to 100 MHz; clock = 1000 MHz
Broadband Random Jitter ²			150		fs rms	Input slew = 1 V/ns, see Figure 11
Crosstalk Induced Jitter			260		fs rms	Calculated from spur energy with an interferer 10 MHz offset from the carrier
CMOS OUTPUTS						
Output Rise/Fall Time	t_R, t_F		525	950	ps	20% to 80%; $C_{LOAD} = 10$ pF 10 pF load
Propagation Delay, Clock-to-CMOS Output	t_{PD}	2.5	3.2	4.2	ns	
Temperature Coefficient			2.2		ps/ $^{\circ}$ C	
Output Skew ¹						
CMOS Outputs in the Same Bank				155	ps	
All CMOS Outputs						
On the Same Part				175	ps	
Across Multiple Parts				640	ps	
Additive Time Jitter						
Integrated Random Jitter			56		fs rms	
Broadband Random Jitter ²			100		fs rms	Input slew = 2 V/ns, see Figure 11
Crosstalk Induced Jitter			260		fs rms	Calculated from spur energy with an interferer 10 MHz offset from the carrier
LVDS-TO-CMOS OUTPUT SKEW³						
LVDS Output(s) and CMOS Output(s) on the Same Part		0.8		1.6	ns	CMOS load = 10 pF and LVDS load = 100 Ω

¹ This is the difference between any two similar delay paths while operating at the same voltage and temperature.

² Calculated from the SNR of the ADC method.

³ Measured at the rising edge of the clock signal.

CLOCK CHARACTERISTICS

Table 3. Clock Output Phase Noise

Parameter	Min	Typ	Max	Unit	Conditions
CLOCK-TO-LVDS ABSOLUTE PHASE NOISE 1000 MHz		-90			Input slew rate > 1 V/ns
		-108			@ 10 Hz offset
		-117			@ 100 Hz offset
		-126			@ 1 kHz offset
		-135			@ 10 kHz offset
		-141			@ 100 kHz offset
		-146			@ 1 MHz offset
CLOCK-TO-CMOS ABSOLUTE PHASE NOISE 200 MHz		-101			Input slew rate > 1 V/ns
		-119			@ 10 Hz offset
		-127			@ 100 Hz offset
		-138			@ 1 kHz offset
		-147			@ 10 kHz offset
		-153			@ 100 kHz offset
		-156			@ 1 MHz offset

LOGIC AND POWER CHARACTERISTICS

Table 4. Control Pin Characteristics

Parameter	Symbol	Min	Typ	Max	Unit	Conditions
CONTROL PINS (IN_SEL, CTRL_x, SLEEP) ¹						
Logic 1 Voltage	V _{IH}	V _S - 0.4			V	
Logic 0 Voltage	V _{IL}		0.4		V	
Logic 1 Current	I _{IH}	5	8	20	μA	
Logic 0 Current	I _{IL}	-5		+5	μA	
Capacitance			2		pF	
POWER						
Supply Voltage Requirement	V _S	1.71	1.8	1.89	V	V _S = 1.8 V ± 5%
LVDS Outputs						
LVDS @ 100 MHz			84	100	mA	Full operation All outputs enabled as LVDS and loaded, R _L = 100 Ω
LVDS @ 1200 MHz			175	215	mA	All outputs enabled as LVDS and loaded, R _L = 100 Ω
CMOS Outputs						
CMOS @ 100 MHz			115	140	mA	Full operation All outputs enabled as CMOS and loaded, C _L = 10 pF
CMOS @ 250 MHz			265	325	mA	All outputs enabled as CMOS and loaded, C _L = 10 pF
SLEEP				3	mA	SLEEP pin pulled high; does not include power dissipated in the external resistors
Power Supply Rejection ²						
LVDS	PSR _{t_{PD}}		0.9		ps/mV	
CMOS	PSR _{t_{PD}}		1.2		ps/mV	

¹ These pins each have a 200 kΩ internal pull-down resistor.

² Change in t_{PD} per change in V_S.

ABSOLUTE MAXIMUM RATINGS

Table 5.

Parameter	Rating
Supply Voltage V _S to GND	2 V
Inputs CLKx and $\overline{\text{CLKx}}$	−0.3 V to +2 V
CMOS Inputs	−0.3 V to +2 V
Outputs Maximum Voltage	−0.3 V to +2 V
Voltage Reference Voltage (V _{REF})	−0.3 to +2 V
Operating Temperature Ambient Range	−40°C to +85°C
Junction	150°C
Storage Temperature Range	−65°C to +150°C

Stresses above those listed under Absolute Maximum Ratings may cause permanent damage to the device. This is a stress rating only; functional operation of the device at these or any other conditions above those indicated in the operational section of this specification is not implied. Exposure to absolute maximum rating conditions for extended periods may affect device reliability.

DETERMINING JUNCTION TEMPERATURE

To determine the junction temperature on the application printed circuit board (PCB), use the following equation:

$$T_j = T_{CASE} + (\Psi_{JT} \times P_D)$$

where:

T_j is the junction temperature (°C).

T_{CASE} is the case temperature (°C) measured by the user at the top center of the package.

Ψ_{JT} is from Table 6.

P_D is the power dissipation.

Values of θ_{JA} are provided for package comparison and PCB design considerations. θ_{JA} can be used for a first-order approximation of T_j by the equation

$$T_j = T_A + (\theta_{JA} \times P_D)$$

where T_A is the ambient temperature (°C).

Values of θ_{JB} are provided in Table 6 for package comparison and PCB design considerations.

ESD CAUTION



ESD (electrostatic discharge) sensitive device. Charged devices and circuit boards can discharge without detection. Although this product features patented or proprietary protection circuitry, damage may occur on devices subjected to high energy ESD. Therefore, proper ESD precautions should be taken to avoid performance degradation or loss of functionality.

THERMAL PERFORMANCE

Table 6.

Parameter	Symbol	Description (Using a 2S2P Test Board)	Value ¹	Unit
Junction-to-Ambient Thermal Resistance Still Air 0.0 m/sec Air Flow	θ_{JA}	Per JEDEC JESD51-2	42	°C/W
Moving Air 1.0 m/sec Air Flow	θ_{JMA}	Per JEDEC JESD51-6	37	°C/W
2.5 m/sec Air Flow			33	°C/W
Junction-to-Board Thermal Resistance Moving Air 1.0 m/sec Air Flow	θ_{JB}	Per JEDEC JESD51-8	26	°C/W
Junction-to-Case Thermal Resistance Moving Air Die-to-Heat Sink	θ_{JC}	Per MIL-STD 883, Method 1012.1	2	°C/W
Junction-to-Top-of-Package Characterization Parameter Still Air 0 m/sec Air Flow	Ψ_{JT}	Per JEDEC JESD51-2	0.5	°C/W

¹ Results are from simulations. The PCB is a JEDEC multilayer type. Thermal performance for actual applications requires careful inspection of the conditions in the application to determine if they are similar to those assumed in these calculations.

PIN CONFIGURATION AND FUNCTION DESCRIPTIONS

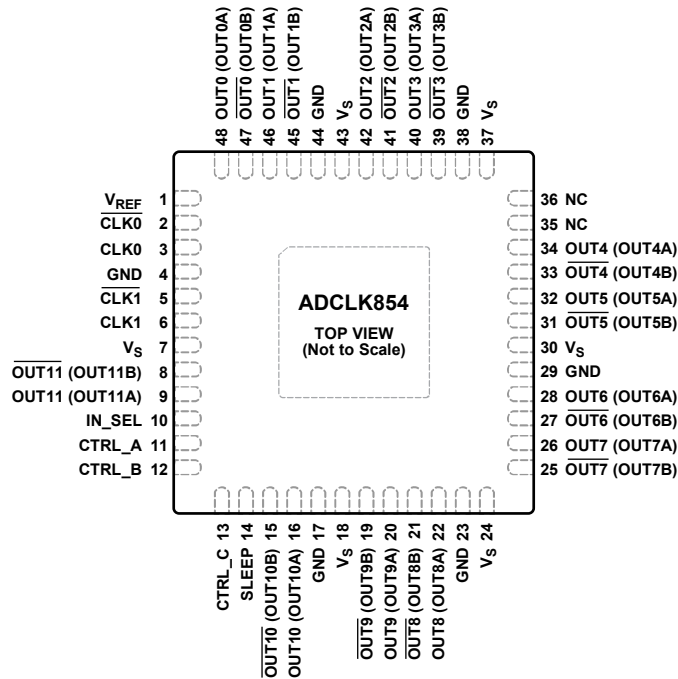

- NOTES:
 1. NC = NO CONNECT.
 2. EXPOSED PADDLE MUST BE CONNECTED TO GND.

07218-002

Figure 2. Pin Configuration

Table 7. Pin Function Descriptions

Pin No.	Mnemonic	Description
1	V_{REF}	Reference Voltage.
2	$\overline{CLK0}$	Input (Negative) 0.
3	CLK0	Input (Positive) 0.
7, 18, 24, 30, 37, 43	V_S	Supply Voltage.
5	$\overline{CLK1}$	Input (Negative) 1.
6	CLK1	Input (Positive) 1.
8	$\overline{OUT11}$ (OUT11B)	Complementary Side of Differential LVDS Output 11, or CMOS Output 11 on Channel B.
9	OUT11 (OUT11A)	True Side of Differential LVDS Output 11, or CMOS Output 11 on Channel A.
10	IN_SEL	Input Select. (0 = CLK0, CLK0; 1 = CLK1, CLK1). CMOS logic input with 200 k Ω pull-down resistor.
11	CTRL_A	Control for Output 3 to Output 0 (0 = LVDS, 1 = CMOS). CMOS logic input with 200 k Ω pull-down resistor.
12	CTRL_B	Control for Output 7 to Output 4 (0 = LVDS, 1 = CMOS). CMOS logic input with 200 k Ω pull-down resistor.
13	CTRL_C	Control for Output 11 to Output 8 (0 = LVDS, 1 = CMOS). CMOS logic input with 200 k Ω pull-down resistor.
14	SLEEP	Sleep Mode Control (0 = normal operation, 1 = sleep). CMOS logic input with 200 k Ω pull down resistor.
15	$\overline{OUT10}$ (OUT10B)	Complementary Side of Differential LVDS Output 10, or CMOS Output 10 on Channel B.
16	OUT10 (OUT10A)	True Side of Differential LVDS Output 10, or CMOS Output 10 on Channel A.
4, 17, 23, 29, 38, 44	GND	Ground Pin.
19	$\overline{OUT9}$ (OUT9B)	Complementary Side of Differential LVDS Output 9, or CMOS Output 9 on Channel B.
20	OUT9 (OUT9A)	True Side of Differential LVDS Output 9, or CMOS Output 9 on Channel A.
21	$\overline{OUT8}$ (OUT8B)	Complementary Side of Differential LVDS Output 8, or CMOS Output 8 on Channel B.
22	OUT8 (OUT8A)	True Side of Differential LVDS Output 8, or CMOS Output 8 on Channel A.
25	$\overline{OUT7}$ (OUT7B)	Complementary Side of Differential LVDS Output 7, or CMOS Output 7 on Channel B.

ADCLK854

Pin No.	Mnemonic	Description
26	OUT7 (OUT7A)	True Side of Differential LVDS Output 7, or CMOS Output 7 on Channel A.
27	$\overline{\text{OUT6}}$ (OUT6B)	Complementary Side of Differential LVDS Output 6, or CMOS Output 6 on Channel B.
28	OUT6 (OUT6A)	True Side of Differential LVDS Output 6, or CMOS Output 6 on Channel A.
31	$\overline{\text{OUT5}}$ (OUT5B)	Complementary Side of Differential LVDS Output 5, or CMOS Output 5 on Channel B.
32	OUT5 (OUT5A)	True Side of Differential LVDS Output 5, or CMOS Output 5 on Channel A.
33	$\overline{\text{OUT4}}$ (OUT4B)	Complementary Side of Differential LVDS Output 4, or CMOS Output 4 on Channel B.
34	OUT4 (OUT4A)	True Side of Differential LVDS Output 4, or CMOS Output 4 on Channel A.
35	NC	No Connect.
36	NC	No Connect.
39	$\overline{\text{OUT3}}$ (OUT3B)	Complementary Side of Differential LVDS Output 3, or CMOS Output 3 on Channel B.
40	OUT3 (OUT3A)	True Side of Differential LVDS Output 3, or CMOS Output 3 on Channel A.
41	$\overline{\text{OUT2}}$ (OUT2B)	Complementary Side of Differential LVDS Output 2, or CMOS Output 2 on Channel B.
42	OUT2 (OUT2A)	True Side of Differential LVDS Output 2, or CMOS Output 2 on Channel A.
45	$\overline{\text{OUT1}}$ (OUT1B)	Complementary Side of Differential LVDS Output 1, or CMOS Output 1 on Channel B.
46	OUT1 (OUT1A)	True Side of Differential LVDS Output 1, or CMOS Output 1 on Channel A.
47	$\overline{\text{OUT0}}$ (OUT0B)	Complementary Side of Differential LVDS Output 0, or CMOS Output 0 on Channel B.
48	OUT0 (OUT0A)	True Side of Differential LVDS Output 0, or CMOS Output 0 on Channel A.
(49)	EPAD	Exposed Paddle. The exposed paddle must be connected to GND.

TYPICAL PERFORMANCE CHARACTERISTICS

$V_S = +1.8\text{ V}$, $T_A = 25^\circ\text{C}$, unless otherwise noted.

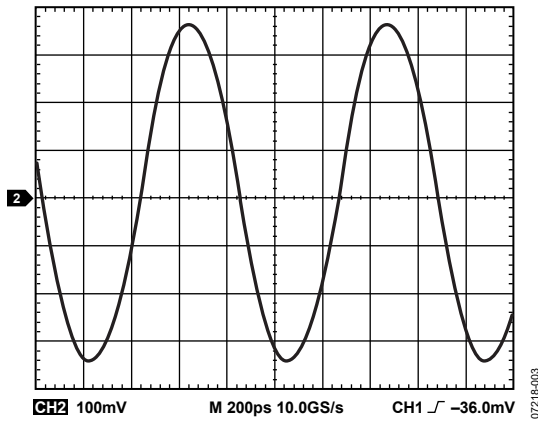

Figure 3. LVDS Output Waveform @ 1200 MHz

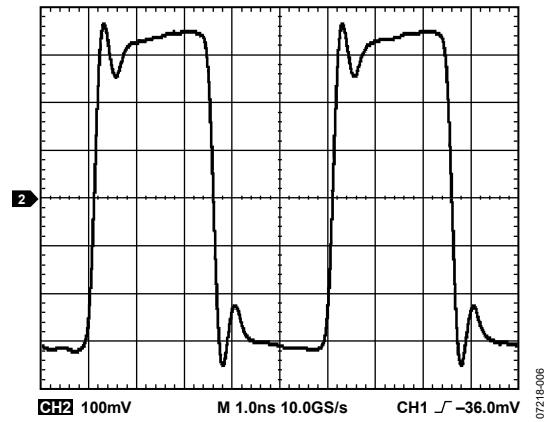

Figure 6. LVDS Output Waveform @ 200 MHz

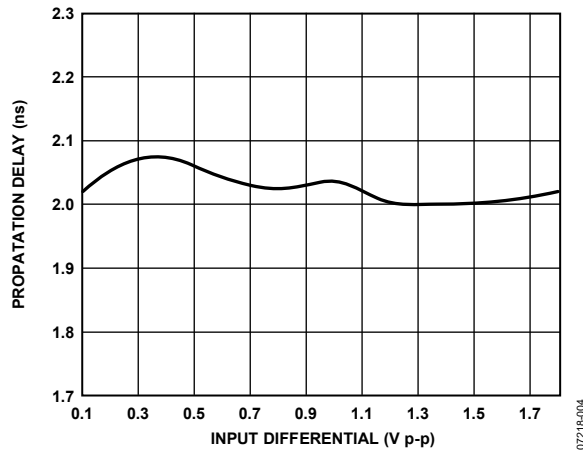

Figure 4. LVDS Propagation Delay vs. Input Differential Voltage (V_D)

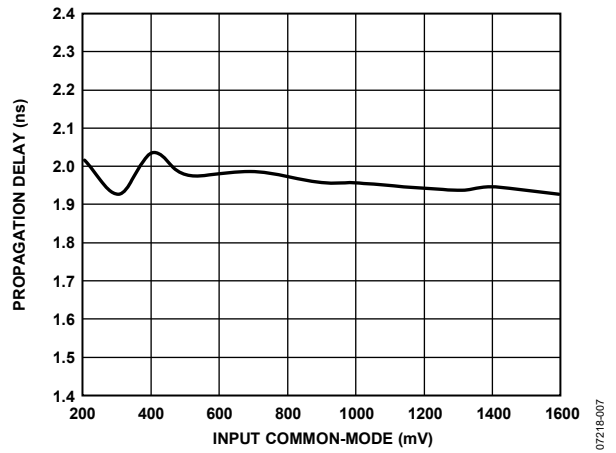

Figure 7. LVDS Propagation Delay vs. V_{ICM}

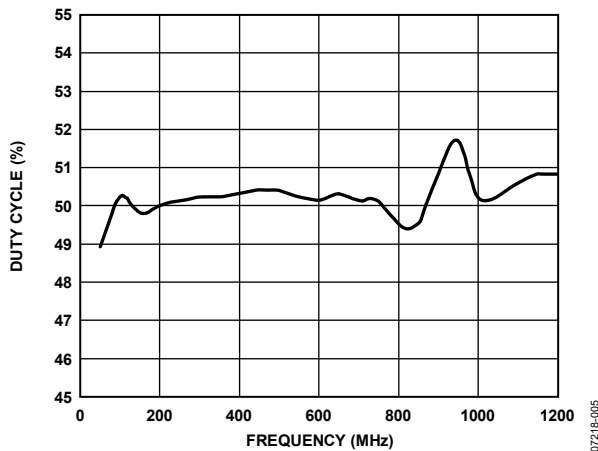

Figure 5. LVDS Output Duty Cycle vs. Frequency

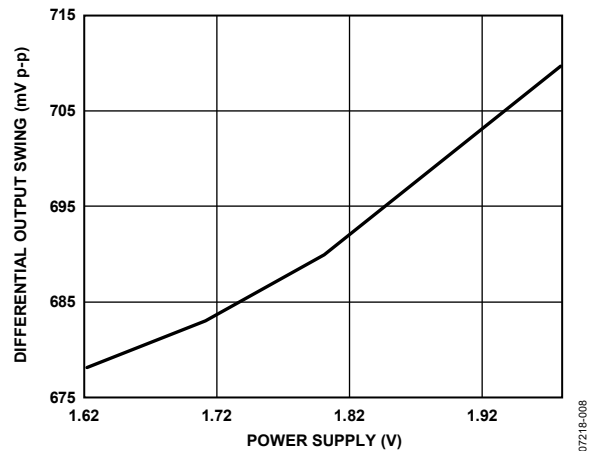

Figure 8. LVDS Differential Output Swing vs. Power Supply Voltage

ADCLK854

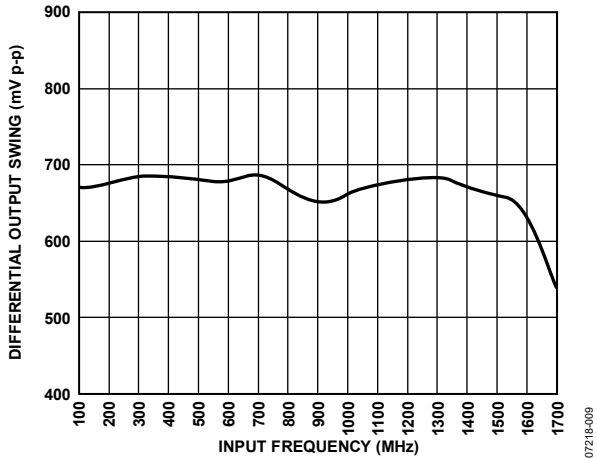

Figure 9. LVDS Differential Output Swing vs. Input Frequency

07218-009

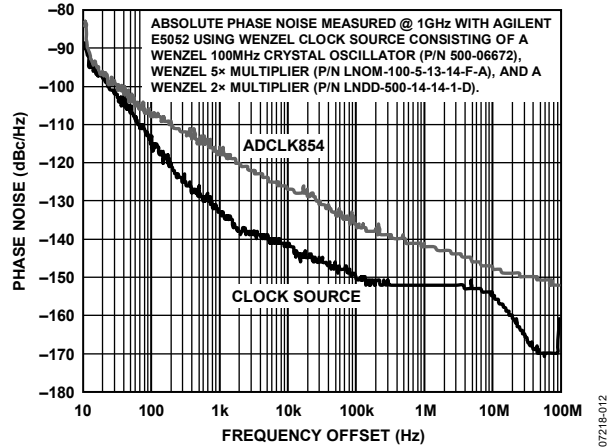

Figure 12. Absolute Phase Noise LVDS @ 1000 MHz

07218-012

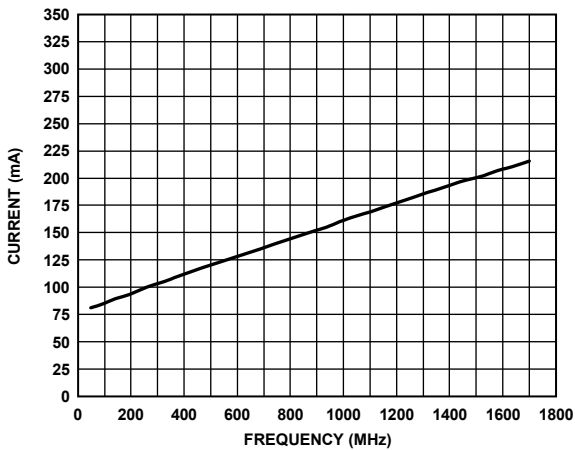

Figure 10. LVDS Current vs. Frequency; All Banks Set to LVDS

07218-110

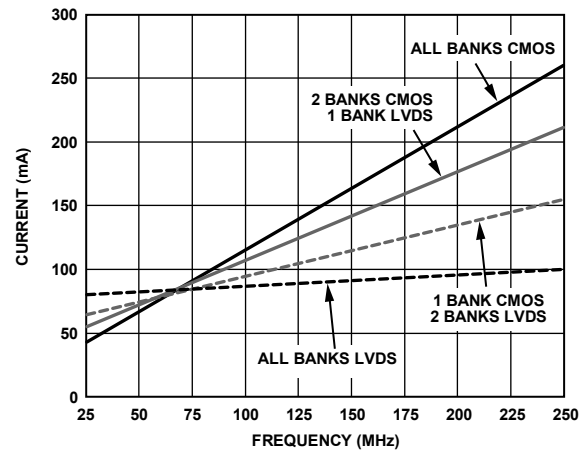

Figure 13. LVDS/CMOS Current vs. Frequency with Various Logic Combinations

07218-113

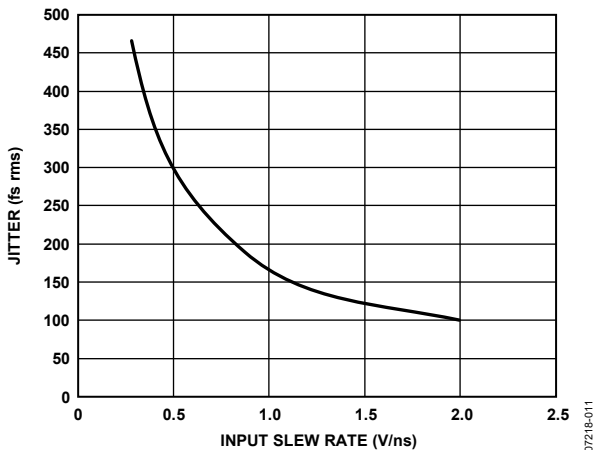

Figure 11. Additive Broadband Jitter vs. Input Slew Rate

07218-011

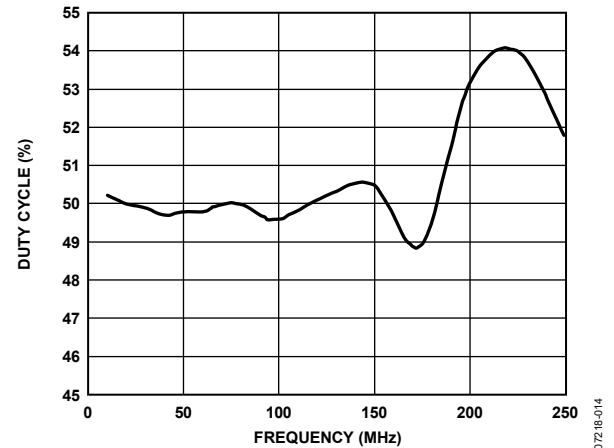

Figure 14. CMOS Output Duty Cycle vs. Frequency (10 pF Load)

07218-014

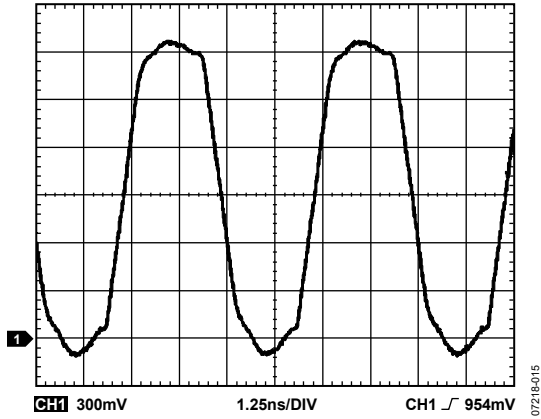

Figure 15. CMOS Output Waveform @ 200 MHz (10 pF Load)

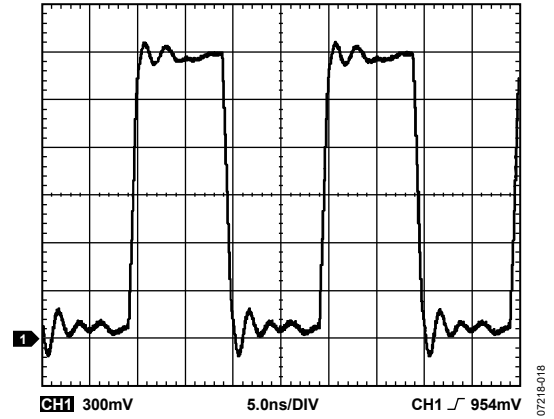

Figure 18. CMOS Output Waveform @ 50 MHz (10 pF Load)

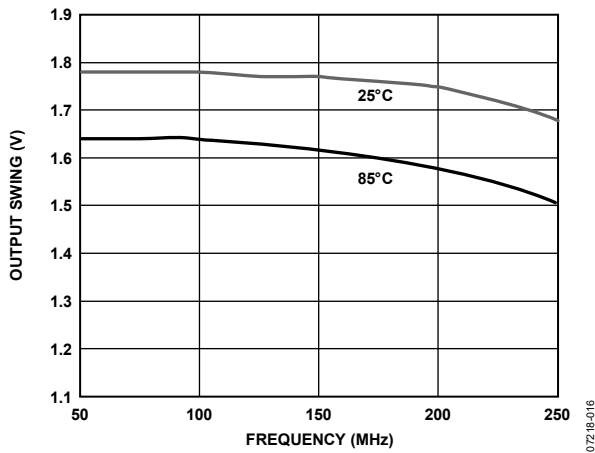

Figure 16. CMOS Output Swing vs. Frequency by Temperature (10 pF Load)

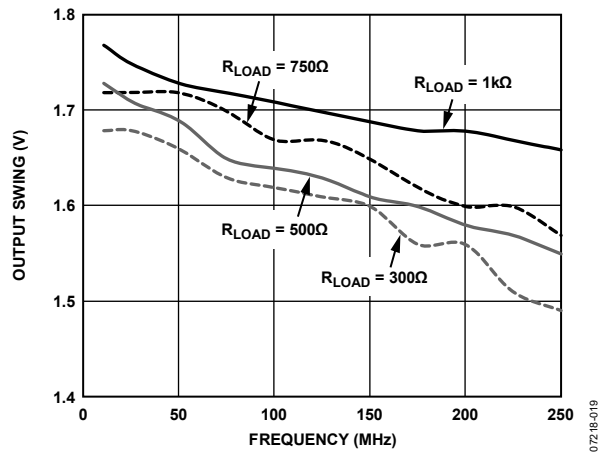

Figure 19. CMOS Output Swing vs. Frequency by Resistive Load

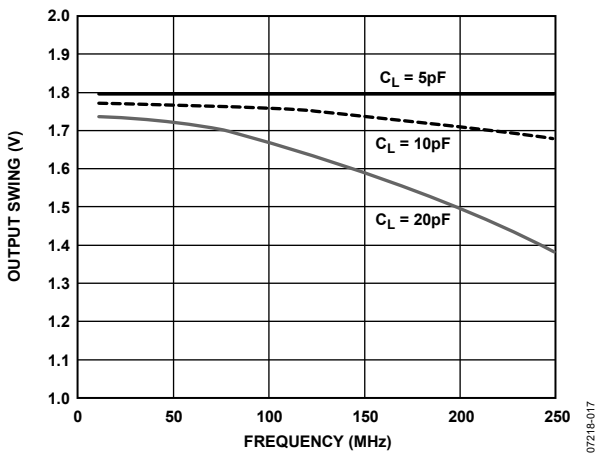

Figure 17. CMOS Output Swing vs. Frequency by Capacitive Load

FUNCTIONAL DESCRIPTION

The ADCLK854 accepts a clock input from one of two inputs and distributes the selected clock to all output channels. The outputs are grouped into three banks of four and can be set to either LVDS or CMOS levels. This allows the selection of multiple logic configurations ranging from 12 LVDS to 24 CMOS outputs, along with other combinations using both types of logic.

CLOCK INPUTS

The ADCLK854 differential inputs are internally self-biased. The clock inputs have a resistor divider that sets the common-mode level for the inputs. The complementary inputs are biased about 30 mV lower than the true input to avoid oscillations if the input signal stops. See Figure 20 for the equivalent input circuit.

The inputs can be ac-coupled or dc-coupled. Table 8 displays a guide for input logic compatibility. A single-ended input can be accommodated by ac or dc coupling to one side of the differential input; bypass the other input to ground with a capacitor.

Note that jitter performance degrades with low input slew rate, as shown in Figure 11. See Figure 27 through Figure 32 for different termination schemes.

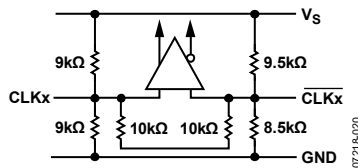

Figure 20. ADCLK854 Input Stage

AC-COUPLED INPUT APPLICATIONS

The ADCLK854 offers two options for ac coupling. The first option requires no external components (excluding the dc blocking capacitor), it allows the user to simply couple the reference signal onto the clock input pins. For more information, see Figure 29.

The second option allows the use of the V_{REF} pin to set the dc bias level for the ADCLK854. The V_{REF} pin can be connected to $CLKx$ and $CLKx$ through resistors. This method allows lower impedance termination of signals at the ADCLK854 (for more information, see Figure 32). The internal bias resistors remain in parallel with the external biasing. However, the relatively high impedance of the internal resistors allows the external termination to V_{REF} to dominate. This method is also useful when offsetting the inputs; using only the internal biasing, as previously mentioned, is not desirable.

CLOCK OUTPUTS

Each driver consists of a differential LVDS output or two single-ended CMOS outputs (always in phase). When the LVDS driver is enabled, the corresponding CMOS driver is in tristate; when the CMOS driver is enabled, the corresponding LVDS driver is powered down and tristated. Figure 21 and Figure 22 display the equivalent output stage.

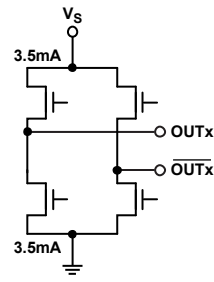

Figure 21. LVDS Output Simplified Equivalent Circuit

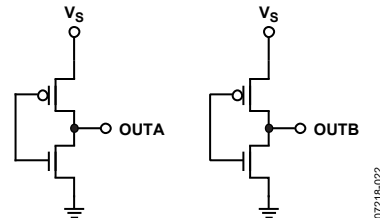

Figure 22. CMOS Output Equivalent Circuit

Table 8. Input Logic Compatibility

Supply (V)	Logic	Common Mode (V)	Output Swing (V)	AC-Coupled	DC-Coupled
3.3	CML	2.9	0.8	Yes	Not allowed
2.5	CML	2.1	0.8	Yes	Not allowed
1.8	CML	1.4	0.8	Yes	Yes
3.3	CMOS	1.65	3.3	Not allowed	Not allowed
2.5	CMOS	1.25	2.5	Not allowed	Not allowed
1.8	CMOS	0.9	1.8	Yes	Yes
1.5	HSTL	0.75	0.75	Yes	Yes
	LVDS	1.25	0.4	Yes	Yes
3.3	LVPECL	2.0	0.8	Yes	Not allowed
2.5	LVPECL	1.2	0.8	Yes	Yes
1.8	LVPECL	0.5	0.8	Yes	Yes

CONTROL AND FUNCTION PINS

CTRL_A—Logic Select

This pin selects either CMOS (high) or LVDS (low) logic for Output 3, Output 2, Output 1, and Output 0. This pin has an internal 200 kΩ pull-down resistor.

CTRL_B—Logic Select

This pin selects either CMOS (high) or LVDS (low) logic for Output 7, Output 6, Output 5, and Output 4. This pin has an internal 200 kΩ pull-down resistor.

CTRL_C—Logic Select

This pin selects either CMOS (high) or LVDS (low) logic for Output 11, Output 10, Output 9, and Output 8. This pin has an internal 200 kΩ pull-down resistor.

IN_SEL—Clock Input Select

A logic low selects CLK0 and $\overline{\text{CLK0}}$ whereas a logic high selects CLK1 and $\overline{\text{CLK1}}$. This pin has an internal 200 kΩ pull-down resistor.

Sleep Mode

Sleep mode powers down the chip except for the internal band gap. The input is active high, which puts the outputs into a high-Z state. This pin has a 200 kΩ pull-down resistor.

POWER SUPPLY

The ADCLK854 requires a $1.8\text{ V} \pm 5\%$ power supply for V_s . Best practice recommends bypassing the power supply on the

PCB with adequate capacitance ($>10\ \mu\text{F}$), and bypassing all power pins with adequate capacitance ($0.1\ \mu\text{F}$) as close to the part as possible. The layout of the ADCLK854 evaluation board (ADCLK854/PCBZ) provides a good layout example.

Exposed Metal Paddle

The exposed metal paddle on the ADCLK854 package is an electrical connection as well as a thermal enhancement. For the device to function properly, the paddle must be properly attached to ground (GND). The ADCLK854 dissipates heat through its exposed paddle. The PCB acts as a heat sink for the ADCLK854. The PCB attachment must provide a good thermal path to a larger heat dissipation area, such as the ground plane on the PCB. This requires a grid of vias from the top layer down to the ground plane. See Figure 23 for an example.

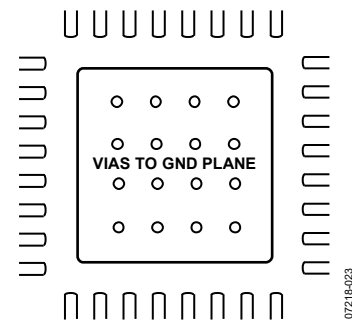

Figure 23. PCB Land for Attaching Exposed Paddle

APPLICATIONS INFORMATION

USING THE ADCLK854 OUTPUTS FOR ADC CLOCK APPLICATIONS

Any high speed, analog-to-digital converter (ADC) is extremely sensitive to the quality of the sampling clock provided by the user. An ADC can be thought of as a sampling mixer, and any noise, distortion, or timing jitter on the clock is combined with the desired signal at the analog-to-digital output. Clock integrity requirements scale with the analog input frequency and resolution, with higher analog input frequency applications at ≥ 14 -bit resolution being the most stringent. The theoretical SNR of an ADC is limited by the ADC resolution and the jitter on the sampling clock. Considering an ideal ADC of infinite resolution where the step size and quantization error can be ignored, the available SNR can be expressed approximately by

$$SNR = 20 \times \log \left[\frac{1}{2\pi f_A T_j} \right]$$

where f_A is the highest analog frequency being digitized and T_j is the rms jitter on the sampling clock.

Figure 24 shows the required sampling clock jitter as a function of the analog frequency and effective number of bits (ENOB). For more information, see Application Note AN-756 and Application Note AN-501 at www.analog.com.

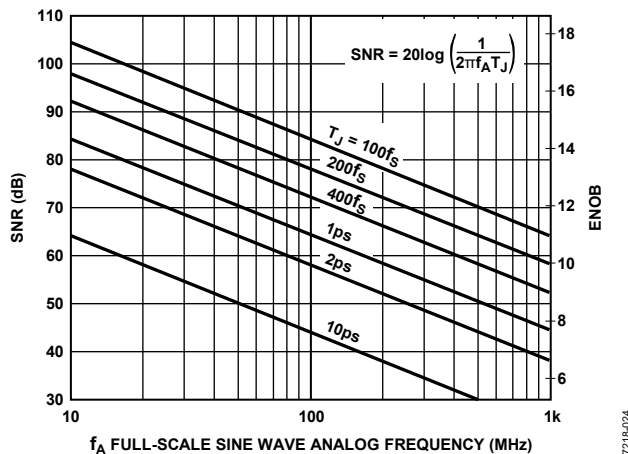

Figure 24. SNR and ENOB vs. Analog Input Frequency

Many high performance ADCs feature differential clock inputs to simplify the task of providing the required low jitter clock on a noisy PCB. Distributing a single-ended clock on a noisy PCB can result in coupled noise on the sample clock. Differential distribution has inherent common-mode rejection that can provide superior clock performance in a noisy environment. Consider the input requirements of the ADC (differential or single-ended, logic level, and termination) when selecting the best clocking/converter solution.

LVDS CLOCK DISTRIBUTION

The ADCLK854 provides clock outputs that are selectable as either CMOS or LVDS level outputs. LVDS is a differential output option that uses a current-mode output stage. The nominal current is 3.5 mA, which yields 350 mV output swing across a 100 Ω resistor. The LVDS output meets or exceeds all ANSI/TIA/EIA-644 specifications. A recommended termination circuit for the LVDS outputs is shown in Figure 25.

If ac coupling is necessary, place decoupling capacitors either before or after the 100 Ω termination resistor. See Application Note AN-586 at www.analog.com for more information on LVDS.

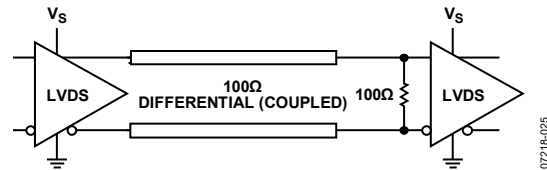

Figure 25. LVDS Output Termination

CMOS CLOCK DISTRIBUTION

The output drivers of the ADCLK854 can be configured as CMOS drivers. When selected as a CMOS driver, each output becomes a pair of CMOS outputs. These outputs are 1.8 V CMOS compatible.

When single-ended CMOS clocking is used, some of the following guidelines apply.

Design point-to-point connections such that each driver has only one receiver, if possible. Connecting outputs in this manner allows for simple termination schemes and minimizes ringing due to possible mismatched impedances on the output trace. Series termination at the source is generally required to provide transmission line matching and/or to reduce current transients at the driver.

The value of the resistor (typically 10 Ω to 100 Ω) is dependent on the board design and timing requirements. CMOS outputs are also limited in terms of the capacitive load or trace length that they can drive. Typically, trace lengths less than 3 inches are recommended to preserve signal rise/fall times and signal integrity.

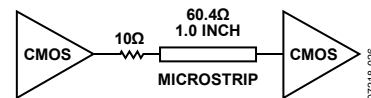

Figure 26. Series Termination of CMOS Output

Termination at the far end of the PCB trace is a second option. The CMOS outputs of the ADCLK854 do not supply enough current to provide a full voltage swing with a low impedance resistive, far end termination, as shown in Figure 27. The far end termination network should match the PCB trace impedance and provide the desired switching point. The reduced signal swing may

still meet receiver input requirements in some applications. This can be useful when driving long trace lengths on less critical networks.

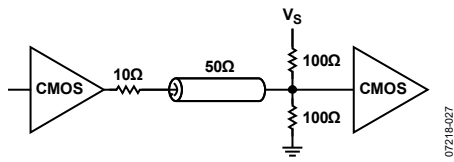

Figure 27. CMOS Output with Far End Termination

Because of the limitations of single-ended CMOS clocking, consider using differential outputs when driving high speed signals over long traces. The ADCLK854 offers LVDS outputs that are better suited for driving long traces wherein the inherent noise immunity of differential signaling provides superior performance for clocking converters.

INPUT TERMINATION OPTIONS

For single-ended operation always bypass unused input to GND, as shown in Figure 31.

Figure 32 illustrates the use of V_{REF} to provide low impedance termination into $V_S/2$. In addition, a way to negate the 30 mV input offset is with external resistor values; for example, using a 1.8 V CMOS with long traces to provide far end termination.

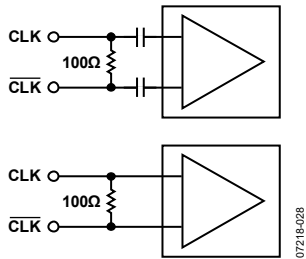

Figure 28. Typical AC-Coupled or DC-Coupled LVDS or HSTL Configuration (See Table 8 for More Information)

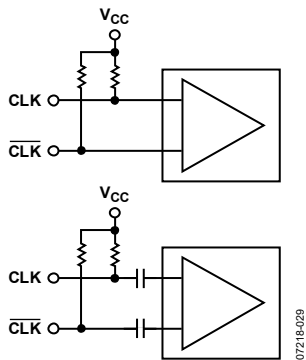

Figure 29. Typical AC-Coupled or DC-Coupled CML Configuration (See Table 8 for CML Coupling Limitations)

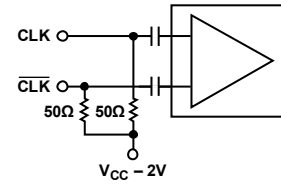
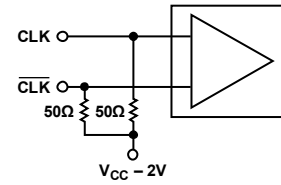

Figure 30. Typical AC-Coupled or DC-Coupled PECL Configuration (See Table 8 for LVPECL DC-Coupling Limitations)

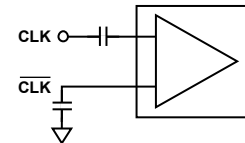
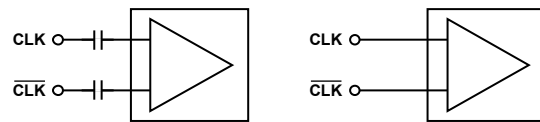

Figure 31. Typical 1.8 V CMOS Configurations for Short Trace Lengths (See Table 8 for CMOS Compatibility)

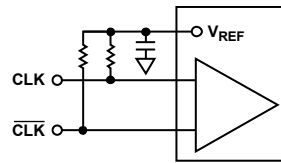
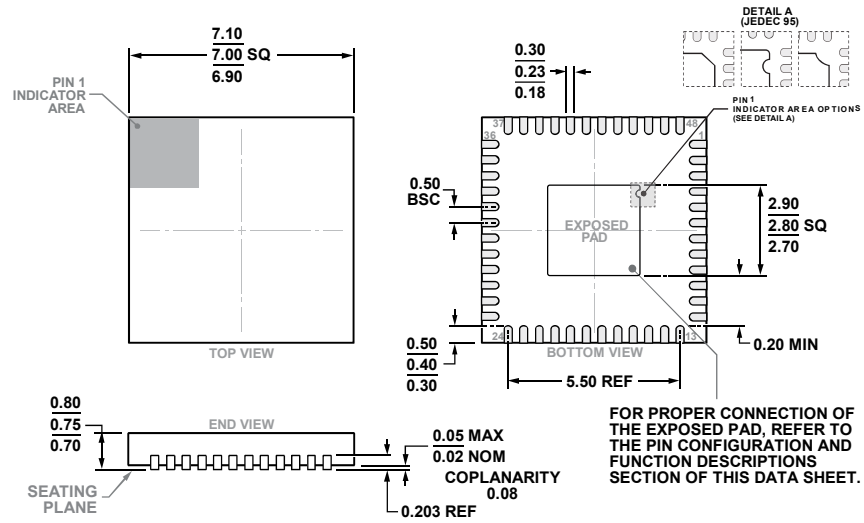

Figure 32. Use of V_{REF} to Provide Low Impedance Termination into $V_S/2$

ADCLK854

OUTLINE DIMENSIONS



COMPLIANT TO JEDEC STANDARDS MO-220-WKKD-2

Figure 33. 48-Lead Lead Frame Chip Scale Package [LFCSP]
7 mm x 7 mm Body and 0.75 mm Package Height
CP-48-21

Dimensions shown in millimeters

ORDERING GUIDE

Model	Temperature Range	Package Description	Package Option
ADCLK854BCPZ ¹	-40°C to +85°C	48-Lead LFCSP	CP-48-21
ADCLK854BCPZ-REEL7 ¹	-40°C to +85°C	48-Lead LFCSP	CP-48-21
ADCLK854/PCBZ ¹		Evaluation Board	

¹ Z = RoHS Compliant Part.

Mouser Electronics

Authorized Distributor

Click to View Pricing, Inventory, Delivery & Lifecycle Information:

[Analog Devices Inc.:](#)

[ADCLK854BCPZ](#) [ADCLK854BCPZ-REEL7](#) [ADCLK854/PCBZ](#)