

MUN5211T1G Series, SMUN5211T1G Series

Bias Resistor Transistor

NPN Silicon Surface Mount Transistor with Monolithic Bias Resistor Network

This new series of digital transistors is designed to replace a single device and its external resistor bias network. The BRT (Bias Resistor Transistor) contains a single transistor with a monolithic bias network consisting of two resistors; a series base resistor and a base-emitter resistor. The BRT eliminates these individual components by integrating them into a single device. The use of a BRT can reduce both system cost and board space. The device is housed in the SC-70/SOT-323 package which is designed for low power surface mount applications.

Features

- Simplifies Circuit Design
- Reduces Board Space
- Reduces Component Count
- The SC-70/SOT-323 package can be soldered using wave or reflow. The modified gull-winged leads absorb thermal stress during soldering eliminating the possibility of damage to the die.
- Available in 8 mm embossed tape and reel. Use the Device Number to order the 7 inch/3000 unit reel.
- S Prefix for Automotive and Other Applications Requiring Unique Site and Control Change Requirements; AEC-Q101 Qualified and PPAP Capable
- These Devices are Pb-Free, Halogen Free/BFR Free and are RoHS Compliant*

MAXIMUM RATINGS (T_A = 25°C unless otherwise noted)

Rating	Symbol	Value	Unit
Collector-Base Voltage	V _{CBO}	50	Vdc
Collector-Emitter Voltage	V _{CEO}	50	Vdc
Collector Current	I _C	100	mAdc

Stresses exceeding Maximum Ratings may damage the device. Maximum Ratings are stress ratings only. Functional operation above the Recommended Operating Conditions is not implied. Extended exposure to stresses above the Recommended Operating Conditions may affect device reliability.



ON Semiconductor®

<http://onsemi.com>

NPN SILICON BIAS RESISTOR TRANSISTORS

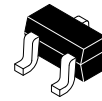

SC-70/SOT-323
CASE 419
STYLE 3

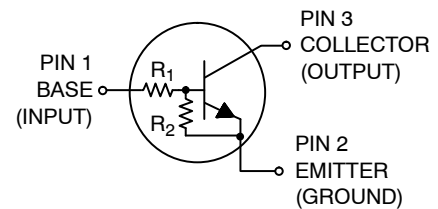

MARKING DIAGRAM

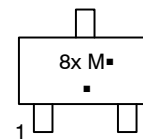

8x = Device Code
M = Date Code*
▪ = Pb-Free Package

(Note: Microdot may be in either location)
*Date Code orientation may vary depending upon manufacturing location.

ORDERING INFORMATION

See detailed ordering and shipping information in the package dimensions section on page 2 of this data sheet.

DEVICE MARKING INFORMATION

See specific marking information in the device marking table on page 2 of this data sheet.

*For additional information on our Pb-Free strategy and soldering details, please download the ON Semiconductor Soldering and Mounting Techniques Reference Manual, SOLDERRM/D.

MUN5211T1G Series, SMUN5211T1G Series

THERMAL CHARACTERISTICS

Characteristic	Symbol	Max	Unit
Total Device Dissipation $T_A = 25^\circ\text{C}$ Derate above 25°C	P_D	202 (Note 1) 310 (Note 2) 1.6 (Note 1) 2.5 (Note 2)	mW mW/ $^\circ\text{C}$
Thermal Resistance, Junction-to-Ambient	$R_{\theta JA}$	618 (Note 1) 403 (Note 2)	$^\circ\text{C}/\text{W}$
Thermal Resistance, Junction-to-Lead	$R_{\theta JL}$	280 (Note 1) 332 (Note 2)	$^\circ\text{C}/\text{W}$
Junction and Storage Temperature Range	T_J, T_{stg}	-55 to +150	$^\circ\text{C}$

- FR-4 @ Minimum Pad.
- FR-4 @ 1.0 x 1.0 inch Pad.

DEVICE MARKING AND RESISTOR VALUES

Device	Package	Marking	R1 (K)	R2 (K)	Shipping [†]
MUN5211T1G, SMUN5211T1G	SC-70/SOT-323 (Pb-Free)	8A	10	10	3,000 / Tape & Reel
SMUN5211T3G	SC-70/SOT-323 (Pb-Free)	8A	10	10	10,000 / Tape & Reel
MUN5212T1G, SMUN5212T1G	SC-70/SOT-323 (Pb-Free)	8B	22	22	3,000 / Tape & Reel
MUN5213T1G, SMUN5213T1G	SC-70/SOT-323 (Pb-Free)	8C	47	47	3,000 / Tape & Reel
MUN5214T1G, SMUN5214T1G	SC-70/SOT-323 (Pb-Free)	8D	10	47	3,000 / Tape & Reel
MUN5215T1G, SMUN5215T1G	SC-70/SOT-323 (Pb-Free)	8E	10	∞	3,000 / Tape & Reel
MUN5216T1G (Note 3)	SC-70/SOT-323 (Pb-Free)	8F	4.7	∞	3,000 / Tape & Reel
MUN5230T1G	SC-70/SOT-323 (Pb-Free)	8G	1.0	1.0	3,000 / Tape & Reel
MUN5231T1G (Note 3)	SC-70/SOT-323 (Pb-Free)	8H	2.2	2.2	3,000 / Tape & Reel
MUN5232T1G, SMUN5232T1G	SC-70/SOT-323 (Pb-Free)	8J	4.7	4.7	3,000 / Tape & Reel
MUN5233T1G, SMUN5233T1G	SC-70/SOT-323 (Pb-Free)	8K	4.7	47	3,000 / Tape & Reel
MUN5234T1G (Note 3)	SC-70/SOT-323 (Pb-Free)	8L	22	47	3,000 / Tape & Reel
MUN5235T1G, SMUN5235T1G	SC-70/SOT-323 (Pb-Free)	8M	2.2	47	3,000 / Tape & Reel
MUN5236T1G (Note 3)	SC-70/SOT-323 (Pb-Free)	8N	100	100	3,000 / Tape & Reel
MUN5237T1G (Note 3)	SC-70/SOT-323 (Pb-Free)	8P	47	22	3,000 / Tape & Reel

[†]For information on tape and reel specifications, including part orientation and tape sizes, please refer to our Tape and Reel Packaging Specifications Brochure, BRD8011/D.

- New devices. Updated curves to follow in subsequent data sheets.

MUN5211T1G Series, SMUN5211T1G Series

ELECTRICAL CHARACTERISTICS ($T_A = 25^\circ\text{C}$ unless otherwise noted)

Characteristic	Symbol	Min	Typ	Max	Unit
OFF CHARACTERISTICS					
Collector-Base Cutoff Current ($V_{CB} = 50\text{ V}, I_E = 0$)	I_{CBO}	-	-	100	nAdc
Collector-Emitter Cutoff Current ($V_{CE} = 50\text{ V}, I_B = 0$)	I_{CEO}	-	-	500	nAdc
Emitter-Base Cutoff Current ($V_{EB} = 6.0\text{ V}, I_C = 0$)	I_{EBO}				mAdc
MUN5211T1G, SMUN5211T1G		-	-	0.5	
MUN5212T1G, SMUN5212T1G		-	-	0.2	
MUN5213T1G, SMUN5213T1G		-	-	0.1	
MUN5214T1G, SMUN5214T1G		-	-	0.2	
MUN5215T1G, SMUN5215T1G		-	-	0.9	
MUN5216T1G		-	-	1.9	
MUN5230T1G		-	-	4.3	
MUN5231T1G		-	-	2.3	
MUN5232T1G, SMUN5232T1G		-	-	1.5	
MUN5233T1G, SMUN5233T1G		-	-	0.18	
MUN5234T1G		-	-	0.13	
MUN5235T1G, SMUN5235T1G		-	-	0.2	
MUN5236T1G		-	-	0.05	
MUN5237T1G		-	-	0.13	
Collector-Base Breakdown Voltage ($I_C = 10\ \mu\text{A}, I_E = 0$)	$V_{(BR)CBO}$	50	-	-	Vdc
Collector-Emitter Breakdown Voltage (Note 4) ($I_C = 2.0\text{ mA}, I_B = 0$)	$V_{(BR)CEO}$	50	-	-	Vdc

ON CHARACTERISTICS (Note 4)

DC Current Gain ($V_{CE} = 10\text{ V}, I_C = 5.0\text{ mA}$)	h_{FE}				
MUN5211T1G, SMUN5211T1G		35	60	-	
MUN5212T1G, SMUN5212T1G		60	100	-	
MUN5213T1G, SMUN5213T1G		80	140	-	
MUN5214T1G, SMUN5214T1G		80	140	-	
MUN5215T1G, SMUN5215T1G		160	350	-	
MUN5216T1G		160	350	-	
MUN5230T1G		3.0	5.0	-	
MUN5231T1G		8.0	15	-	
MUN5232T1G, SMUN5232T1G		15	30	-	
MUN5233T1G, SMUN5233T1G		80	200	-	
MUN5234T1G		80	150	-	
MUN5235T1G, SMUN5235T1G		80	140	-	
MUN5236T1G		80	150	-	
MUN5237T1G		80	140	-	
Collector-Emitter Saturation Voltage ($I_C = 10\text{ mA}, I_B = 0.3\text{ mA}$)	$V_{CE(sat)}$				Vdc
MUN5211T1G, SMUN5211T1G		-	-	0.25	
MUN5212T1G, SMUN5212T1G		-	-	0.25	
MUN5213T1G, SMUN5213T1G		-	-	0.25	
MUN5214T1G, SMUN5214T1G		-	-	0.25	
MUN5236T1G		-	-	0.25	
($I_C = 10\text{ mA}, I_B = 5\text{ mA}$)					
MUN5230T1G		-	-	0.25	
MUN5231T1G		-	-	0.25	
MUN5237T1G		-	-	0.25	
($I_C = 10\text{ mA}, I_B = 1\text{ mA}$)					
MUN5215T1G, SMUN5215T1G		-	-	0.25	
MUN5216T1G		-	-	0.25	
MUN5232T1G, SMUN5232T1G		-	-	0.25	
MUN5233T1G, SMUN5233T1G		-	-	0.25	
MUN5234T1G		-	-	0.25	
MUN5235T1G, SMUN5235T1G		-	-	0.25	

4. Pulse Test: Pulse Width < 300 μs , Duty Cycle < 2.0%

MUN5211T1G Series, SMUN5211T1G Series

ELECTRICAL CHARACTERISTICS (T_A = 25°C unless otherwise noted) (Continued)

Characteristic	Symbol	Min	Typ	Max	Unit
ON CHARACTERISTICS (Note 5) (Continued)					
Output Voltage (on) (V _{CC} = 5.0 V, V _B = 2.5 V, R _L = 1.0 kΩ) MUN5211T1G, SMUN5211T1G MUN5212T1G, SMUN5212T1G MUN5214T1G, SMUN5214T1G MUN5215T1G, SMUN5215T1G MUN5216T1G MUN5230T1G MUN5231T1G MUN5232T1G, SMUN5232T1G MUN5233T1G, SMUN5233T1G MUN5234T1G MUN5235T1G, SMUN5235T1G (V _{CC} = 5.0 V, V _B = 3.5 V, R _L = 1.0 kΩ) MUN5213T1G, SMUN5213T1G (V _{CC} = 5.0 V, V _B = 5.5 V, R _L = 1.0 kΩ) MUN5236T1G (V _{CC} = 5.0 V, V _B = 4.0 V, R _L = 1.0 kΩ) MUN5237T1G	V _{OL}	–	–	0.2	Vdc
Output Voltage (off) (V _{CC} = 5.0 V, V _B = 0.5 V, R _L = 1.0 kΩ) MUN5211T1G, SMUN5211T1G MUN5212T1G, SMUN5212T1G MUN5213T1G, SMUN5213T1G MUN5214T1G, SMUN5214T1G MUN5234T1G MUN5235T1G, SMUN5235T1G (V _{CC} = 5.0 V, V _B = 0.05 V, R _L = 1.0 kΩ) MUN5230T1G (V _{CC} = 5.0 V, V _B = 0.25 V, R _L = 1.0 kΩ) MUN5215T1G, SMUN5215T1G MUN5216T1G MUN5231T1G MUN5232T1G, SMUN5232T1G MUN5233T1G, SMUN5233T1G MUN5236T1G MUN5237T1G	V _{OH}	4.9	–	–	Vdc
Input Resistor MUN5211T1G, SMUN5211T1G MUN5212T1G, SMUN5212T1G MUN5213T1G, SMUN5213T1G MUN5214T1G, SMUN5214T1G MUN5215T1G, SMUN5215T1G MUN5216T1G MUN5230T1G MUN5231T1G MUN5232T1G, SMUN5232T1G MUN5233T1G, SMUN5233T1G MUN5234T1G MUN5235T1G, SMUN5235T1G MUN5236T1G MUN5237T1G	R ₁	7.0 15.4 32.9 7.0 7.0 3.3 0.7 1.5 3.3 3.3 15.4 1.54 70 32.9	10 22 47 10 10 4.7 1.0 2.2 4.7 4.7 22 2.2 100 47	13 28.6 61.1 13 13 6.1 1.3 2.9 6.1 6.1 28.6 2.86 130 61.1	kΩ
Resistor Ratio MUN5211T1G, SMUN5211T1G MUN5212T1G, SMUN5212T1G MUN5213T1G, SMUN5213T1G MUN5214T1G, SMUN5214T1G MUN5215T1G, SMUN5215T1G MUN5216T1G MUN5230T1G MUN5231T1G MUN5232T1G, SMUN5232T1G MUN5233T1G, SMUN5233T1G MUN5234T1G MUN5235T1G, SMUN5235T1G MUN5236T1G MUN5237T1G	R ₁ /R ₂	0.8 0.8 0.8 0.17 – – 0.8 0.8 0.8 0.055 0.38 0.038 0.8 1.7	1.0 1.0 1.0 0.21 – – 1.0 1.0 1.0 0.1 0.47 0.047 1.0 2.1	1.2 1.2 1.2 0.25 – – 1.2 1.2 1.2 0.185 0.56 0.056 1.2 2.6	

5. Pulse Test: Pulse Width < 300 μs, Duty Cycle < 2.0%

MUN5211T1G Series, SMUN5211T1G Series

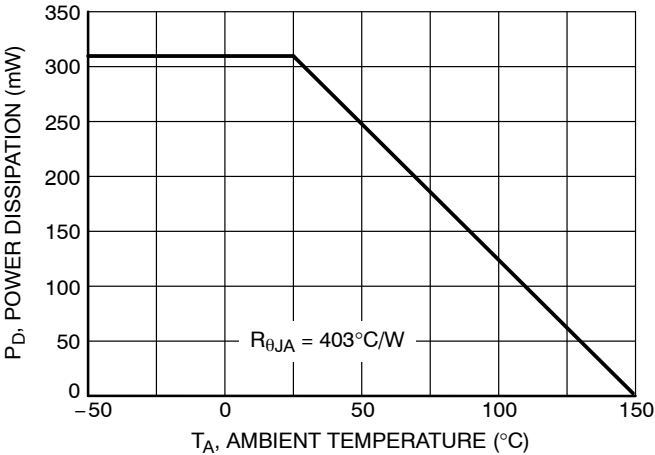

Figure 1. Derating Curve

MUN5211T1G Series, SMUN5211T1G Series

TYPICAL ELECTRICAL CHARACTERISTICS – MUN5211T1G, SMUN5211T1G

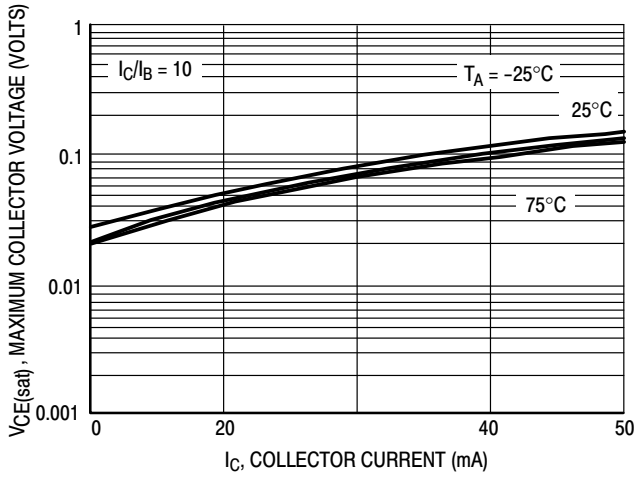

Figure 2. $V_{CE(sat)}$ versus I_C

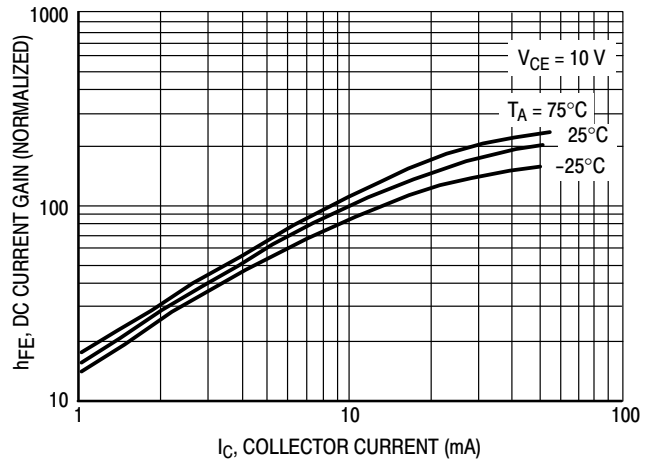

Figure 3. DC Current Gain

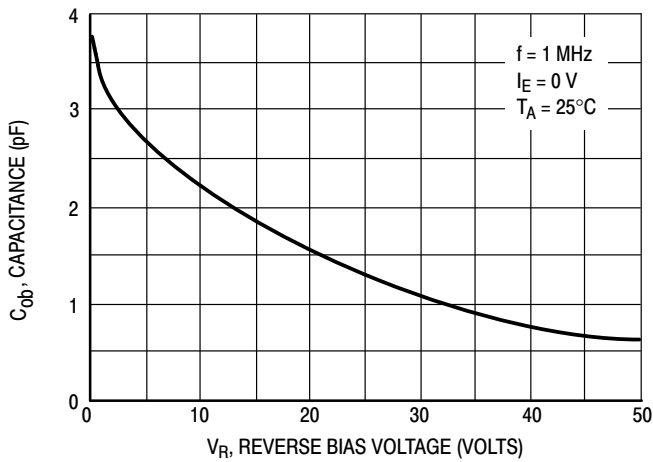

Figure 4. Output Capacitance

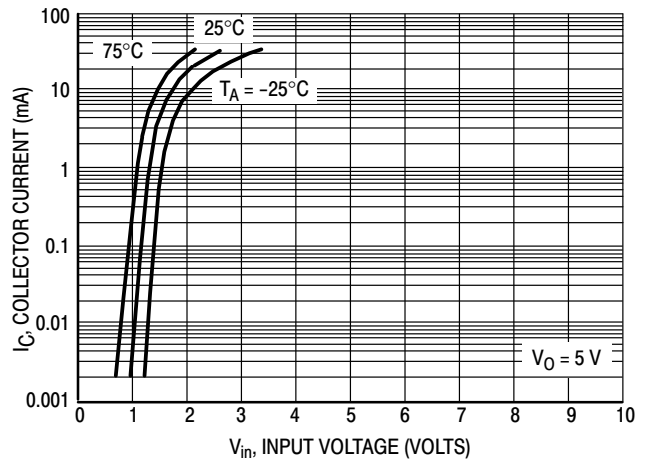

Figure 5. Output Current versus Input Voltage

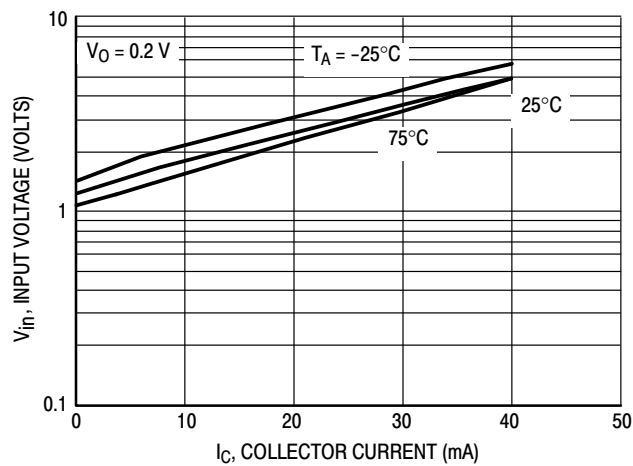

Figure 6. Input Voltage versus Output Current

MUN5211T1G Series, SMUN5211T1G Series

TYPICAL ELECTRICAL CHARACTERISTICS – MUN5212T1G, SMUN5212T1G

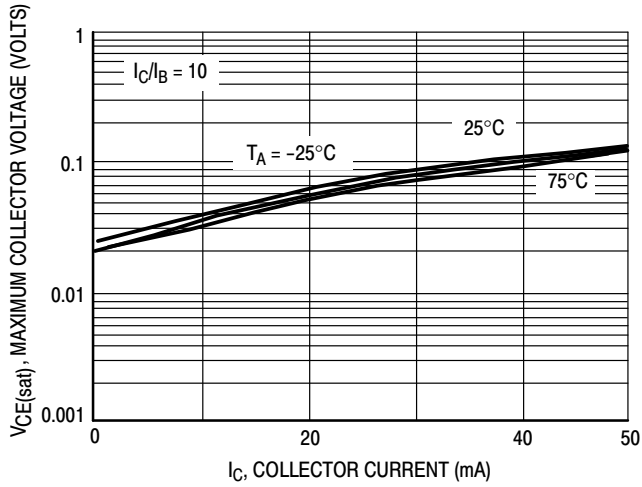

Figure 7. $V_{CE(sat)}$ versus I_C

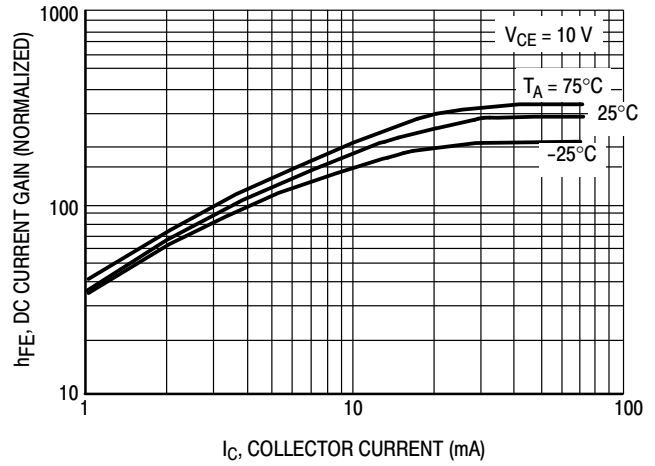

Figure 8. DC Current Gain

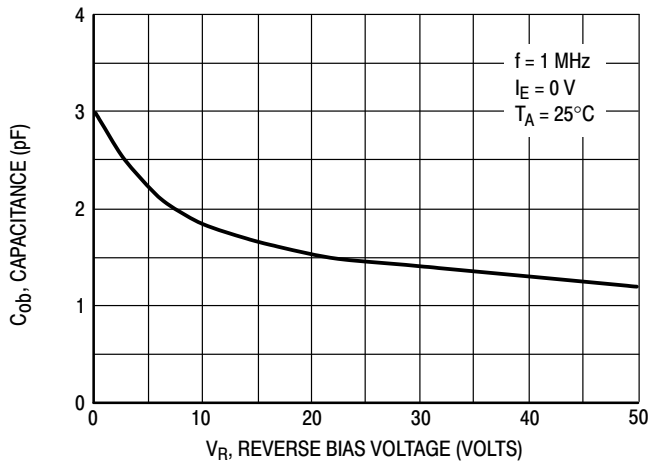

Figure 9. Output Capacitance

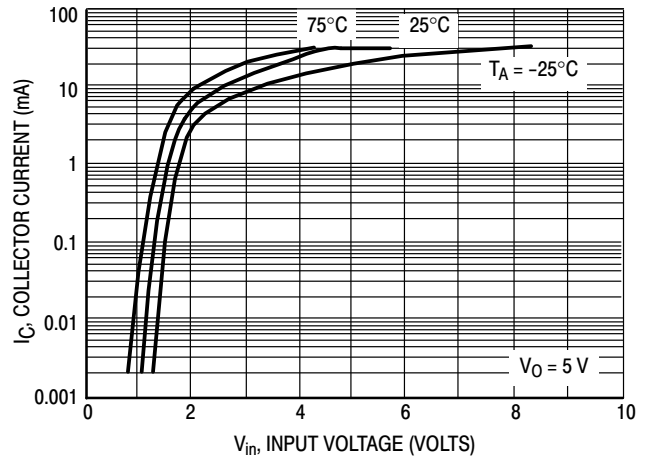

Figure 10. Output Current versus Input Voltage

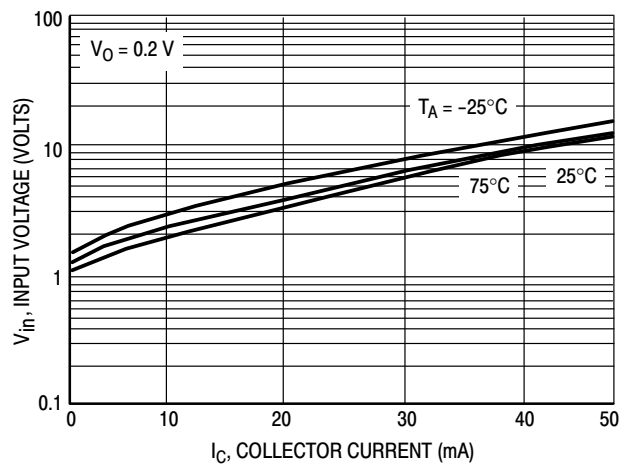

Figure 11. Input Voltage versus Output Current

MUN5211T1G Series, SMUN5211T1G Series

TYPICAL ELECTRICAL CHARACTERISTICS – MUN5213T1G, SMUN5213T1G

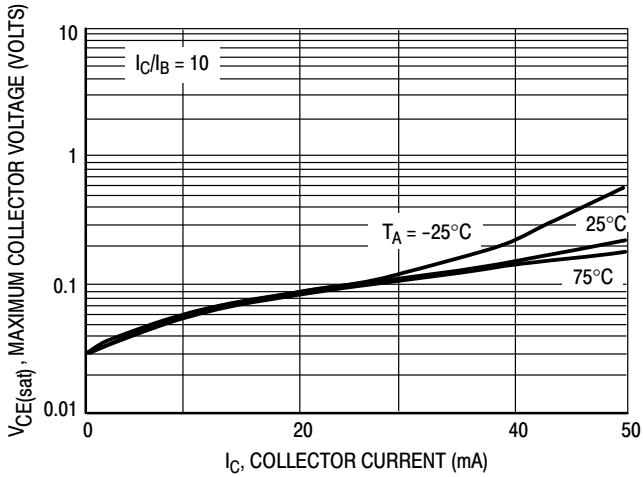

Figure 12. $V_{CE(sat)}$ versus I_C

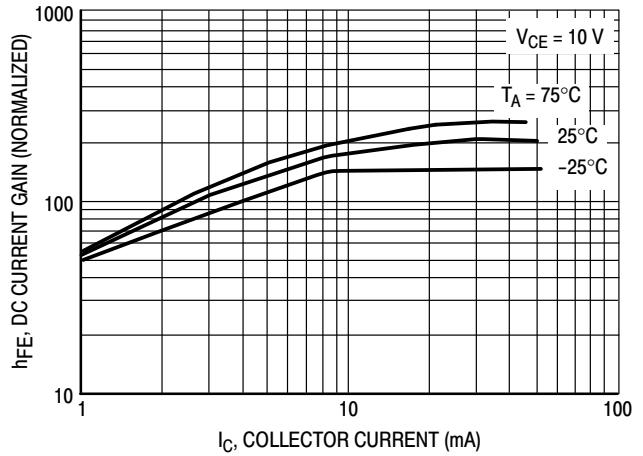

Figure 13. DC Current Gain

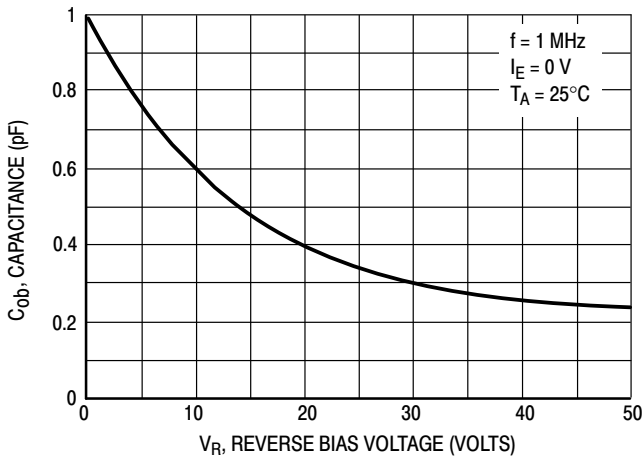

Figure 14. Output Capacitance

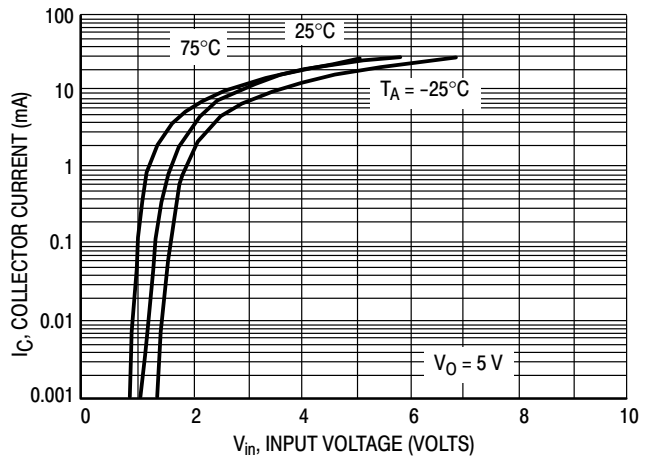

Figure 15. Output Current versus Input Voltage

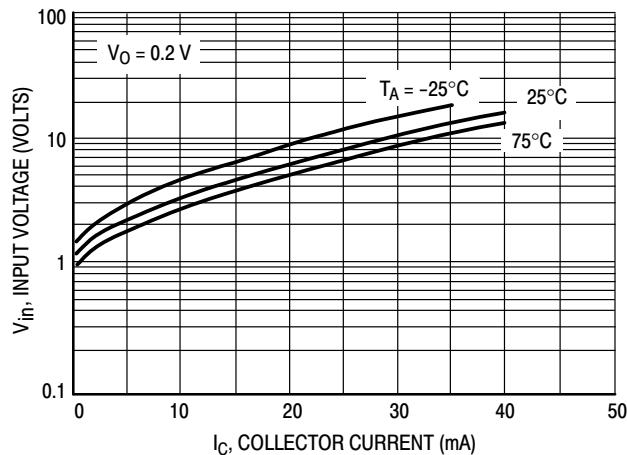

Figure 16. Input Voltage versus Output Current

MUN5211T1G Series, SMUN5211T1G Series

TYPICAL ELECTRICAL CHARACTERISTICS – MUN5214T1G, SMUN5214T1G

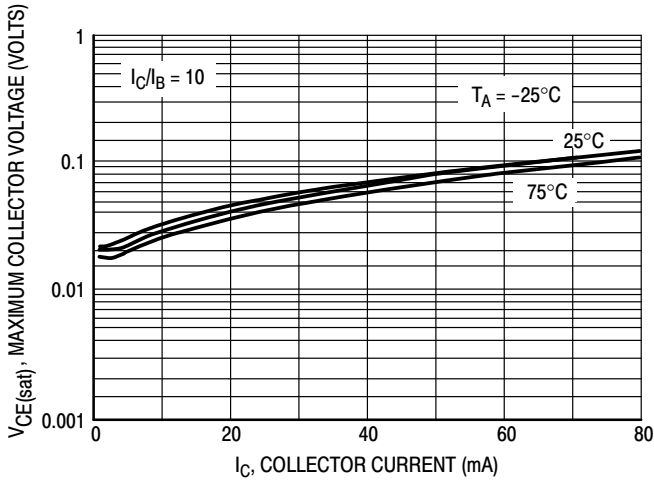

Figure 17. $V_{CE(sat)}$ versus I_C

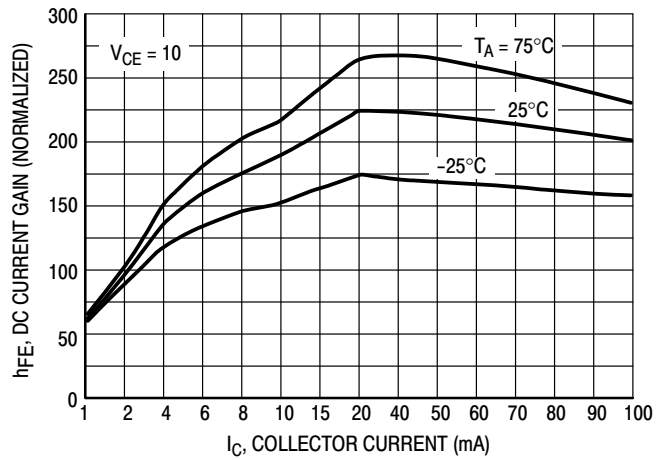

Figure 18. DC Current Gain

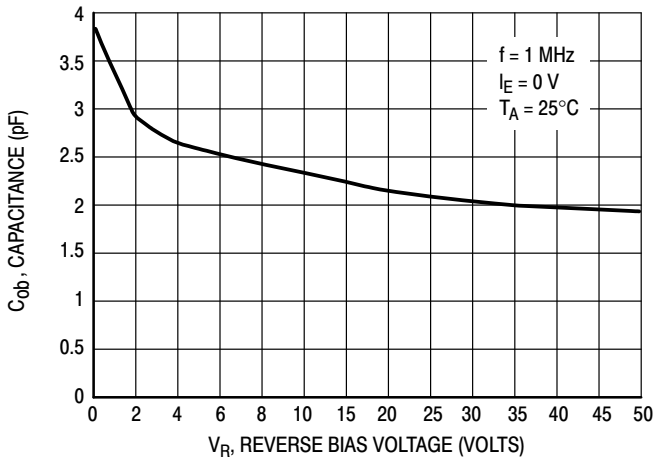

Figure 19. Output Capacitance

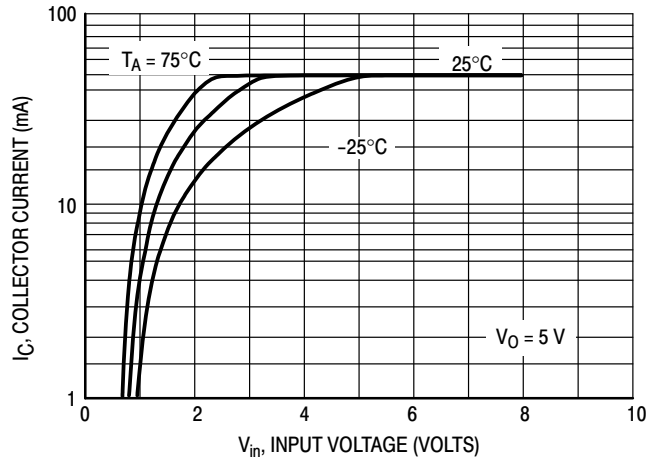

Figure 20. Output Current versus Input Voltage

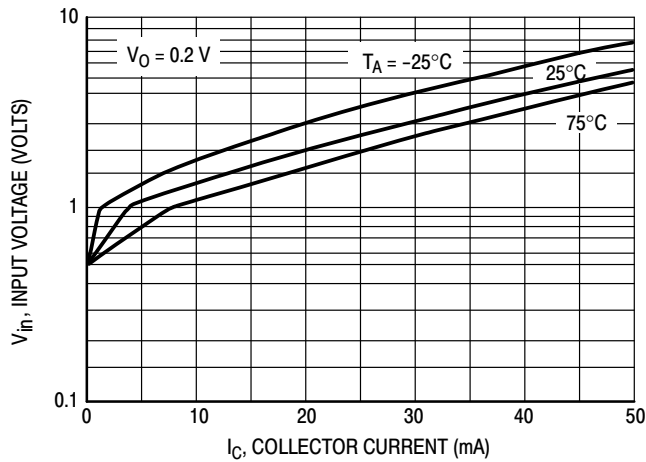

Figure 21. Input Voltage versus Output Current

MUN5211T1G Series, SMUN5211T1G Series

TYPICAL ELECTRICAL CHARACTERISTICS — MUN5215T1G, SMUN5215T1G

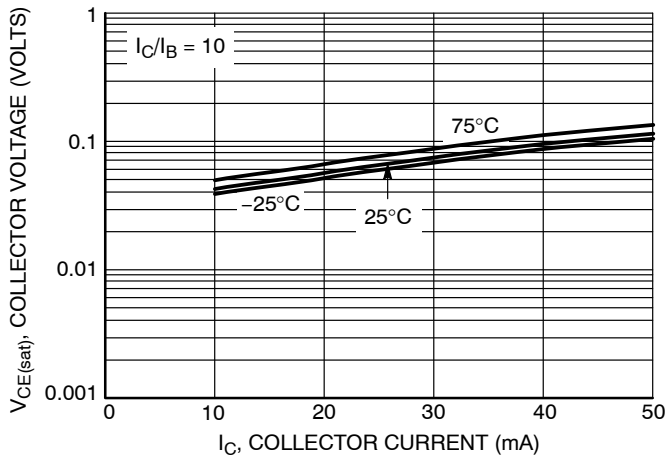

Figure 22. $V_{CE(sat)}$ versus I_C

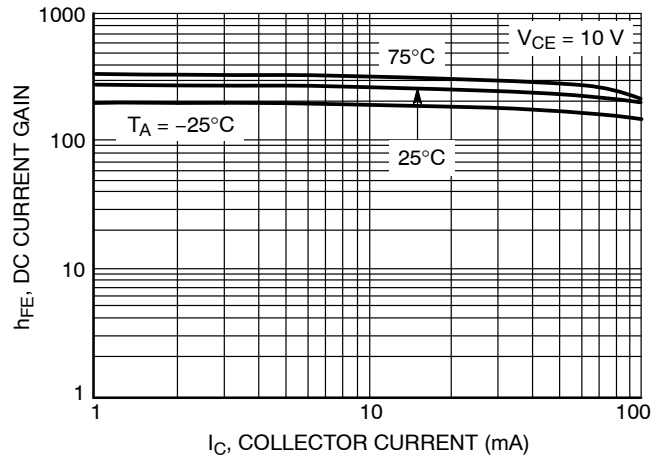

Figure 23. DC Current Gain

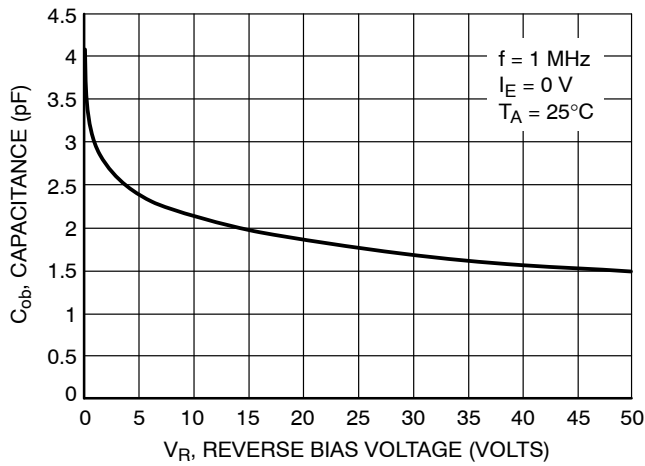

Figure 24. Output Capacitance

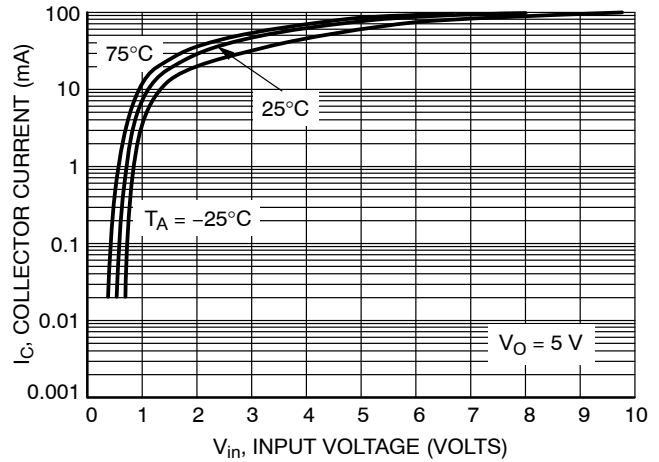

Figure 25. Output Current versus Input Voltage

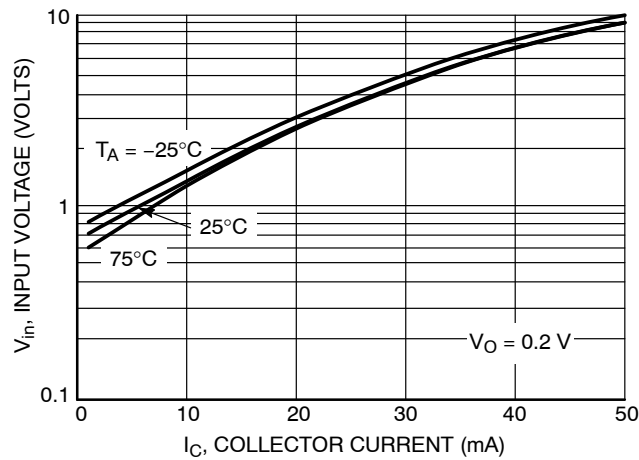

Figure 26. Input Voltage versus Output Current

MUN5211T1G Series, SMUN5211T1G Series

TYPICAL ELECTRICAL CHARACTERISTICS — MUN5230T1G

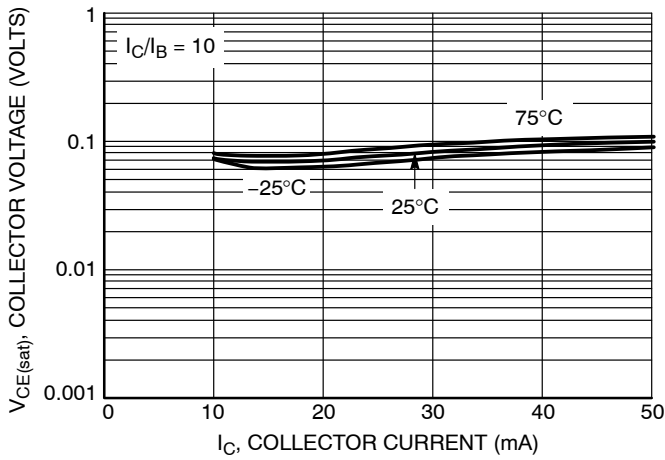

Figure 27. $V_{CE(sat)}$ versus I_C

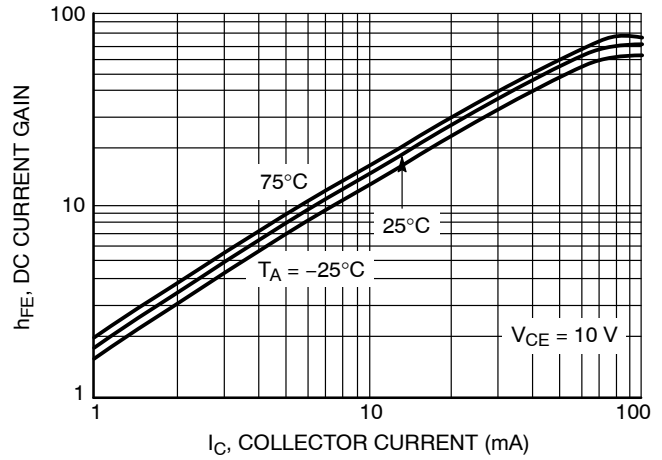

Figure 28. DC Current Gain

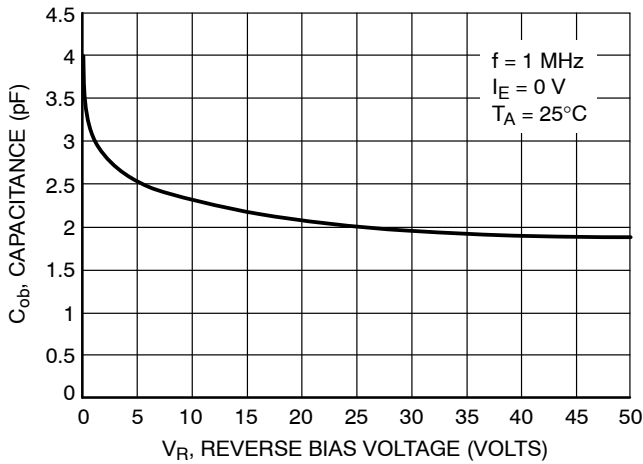

Figure 29. Output Capacitance

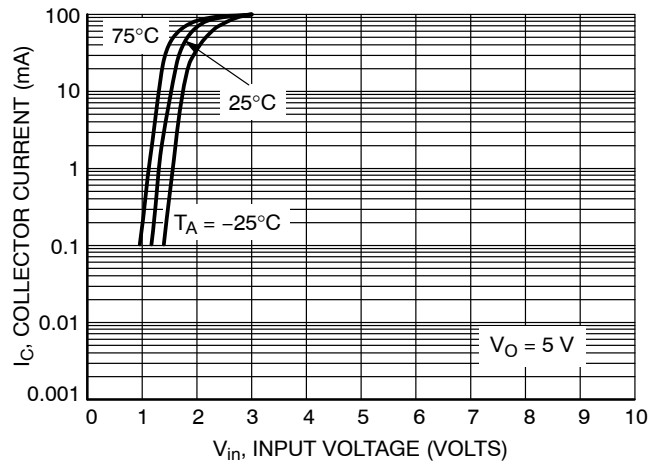

Figure 30. Output Current versus Input Voltage

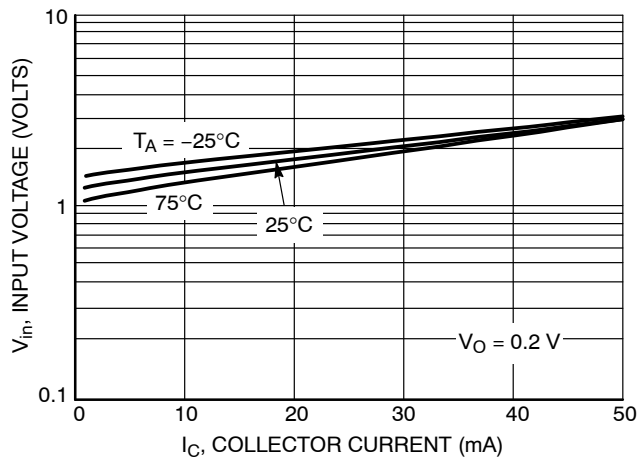

Figure 31. Input Voltage versus Output Current

MUN5211T1G Series, SMUN5211T1G Series

TYPICAL ELECTRICAL CHARACTERISTICS — MUN5232T1G, SMUN5232T1G

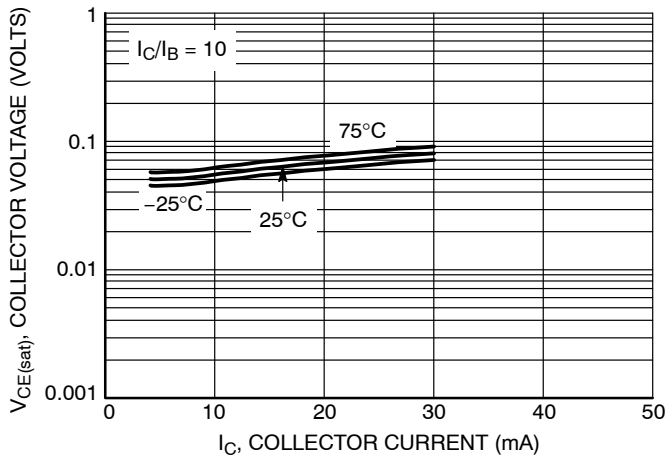

Figure 32. $V_{CE(sat)}$ versus I_C

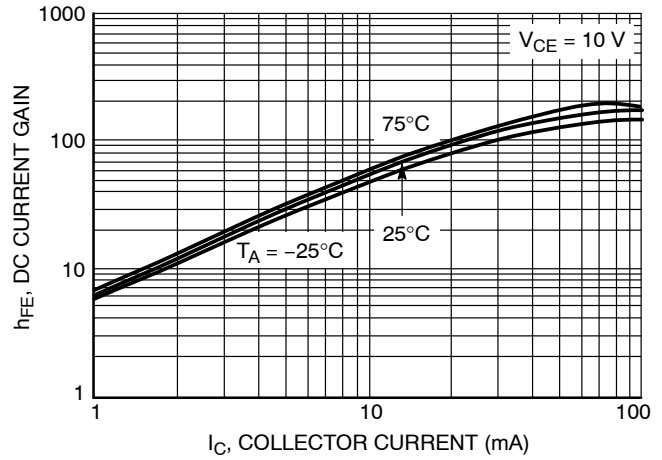

Figure 33. DC Current Gain

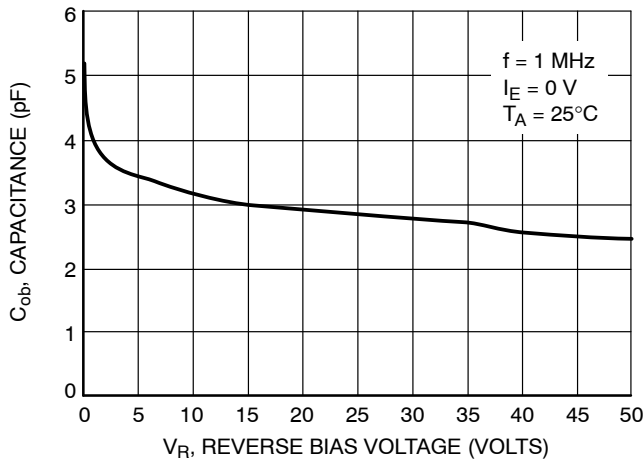

Figure 34. Output Capacitance

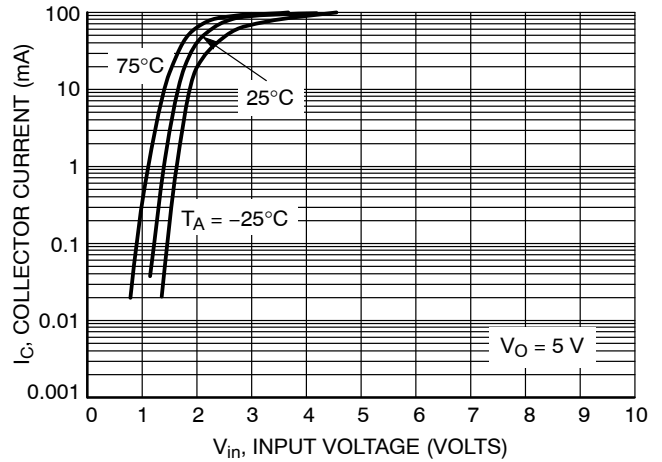

Figure 35. Output Current versus Input Voltage

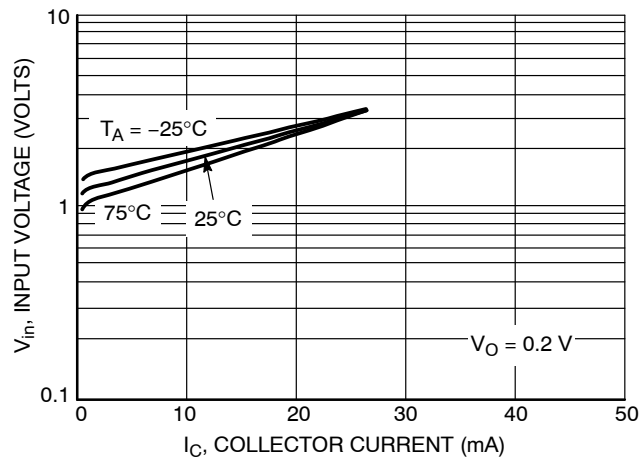

Figure 36. Input Voltage versus Output Current

MUN5211T1G Series, SMUN5211T1G Series

TYPICAL ELECTRICAL CHARACTERISTICS — MUN5233T1G, SMUN5233T1G

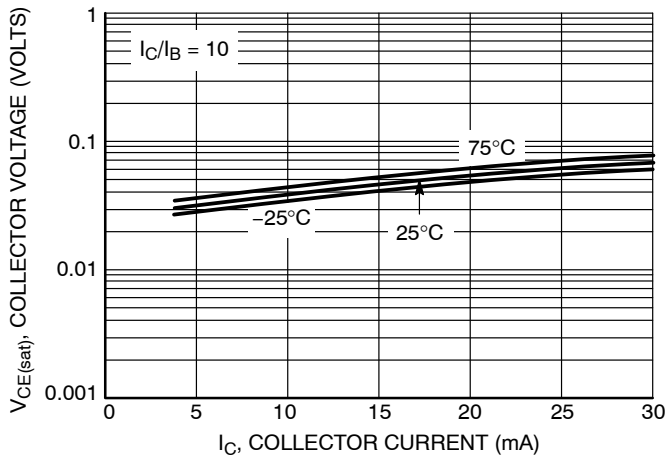

Figure 37. $V_{CE(sat)}$ versus I_C

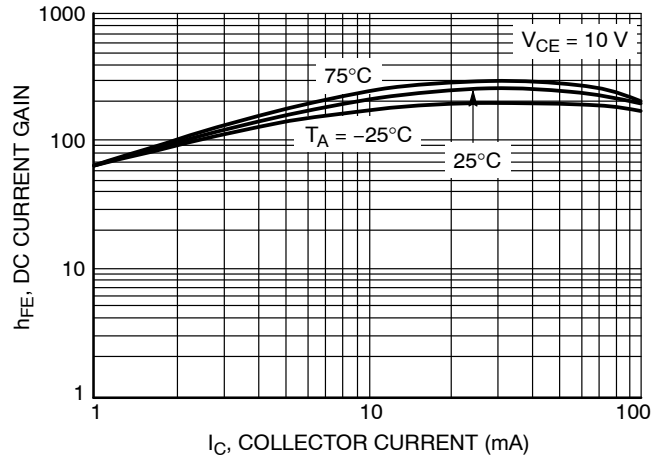

Figure 38. DC Current Gain

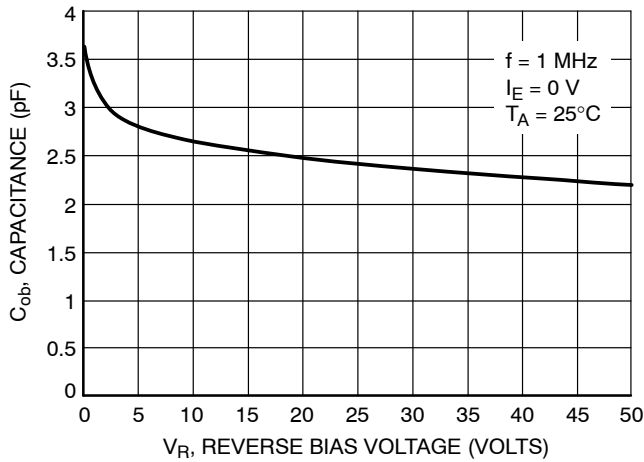

Figure 39. Output Capacitance

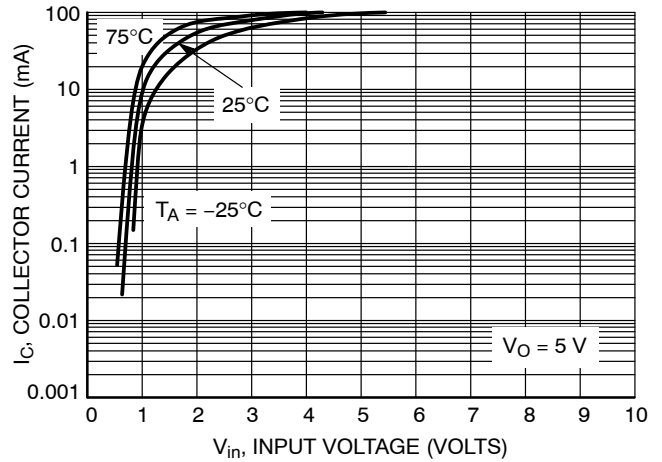

Figure 40. Output Current versus Input Voltage

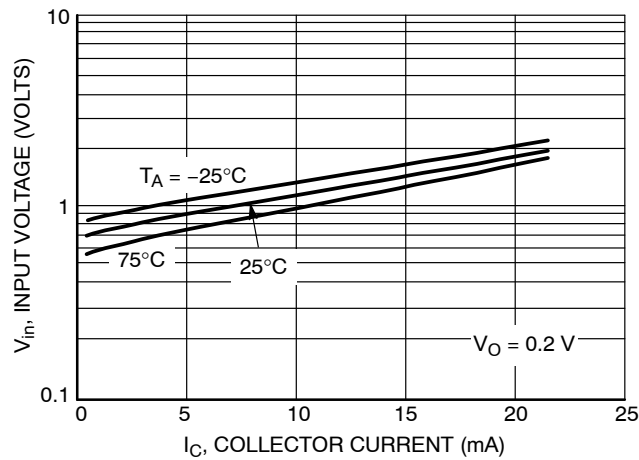

Figure 41. Input Voltage versus Output Current

MUN5211T1G Series, SMUN5211T1G Series

TYPICAL ELECTRICAL CHARACTERISTICS — MUN5235T1G, SMUN5235T1G

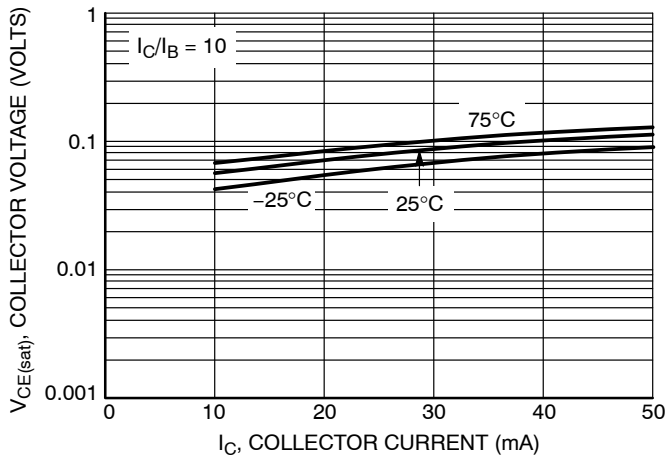

Figure 42. $V_{CE(sat)}$ versus I_C

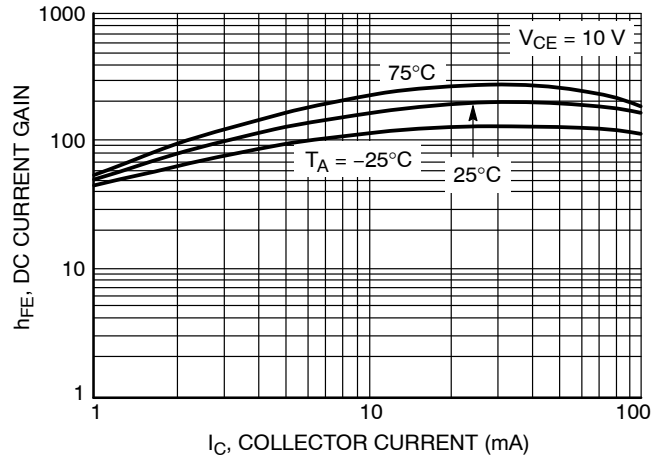

Figure 43. DC Current Gain

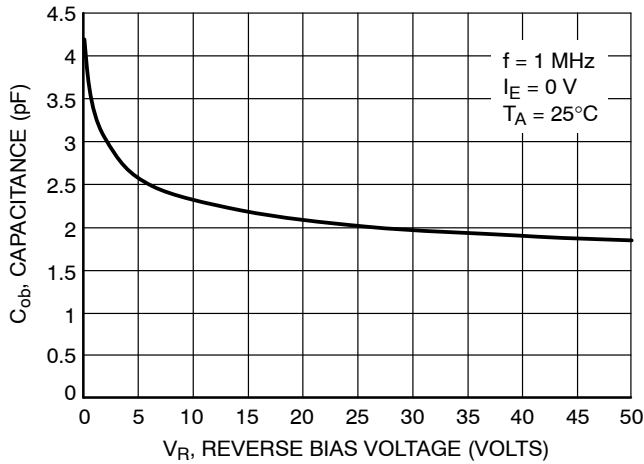

Figure 44. Output Capacitance

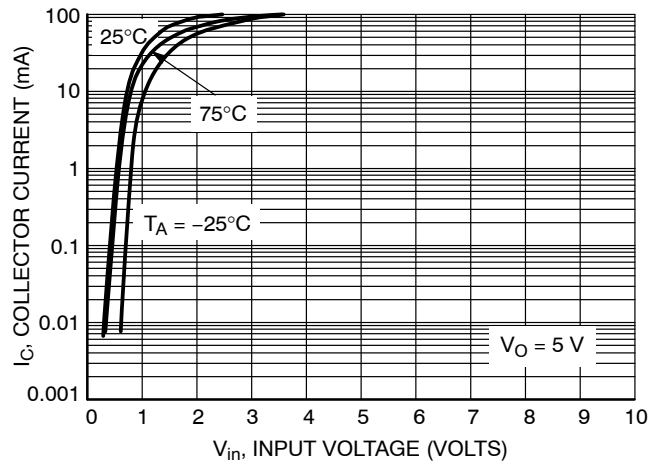

Figure 45. Output Current versus Input Voltage

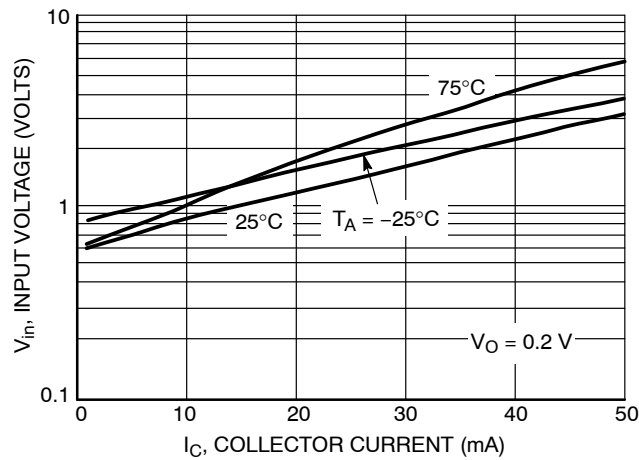

Figure 46. Input Voltage versus Output Current

MUN5211T1G Series, SMUN5211T1G Series

TYPICAL APPLICATIONS FOR NPN BRTs

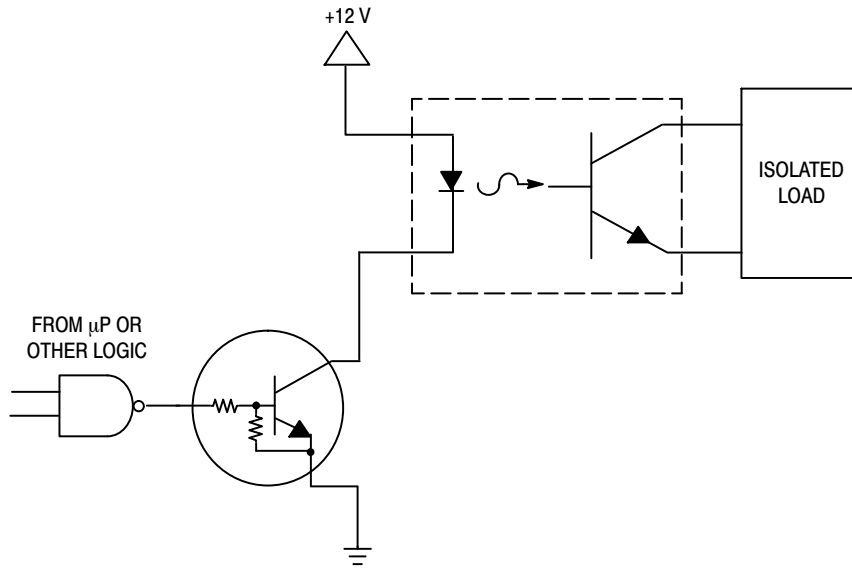

Figure 47. Level Shifter: Connects 12 or 24 Volt Circuits to Logic

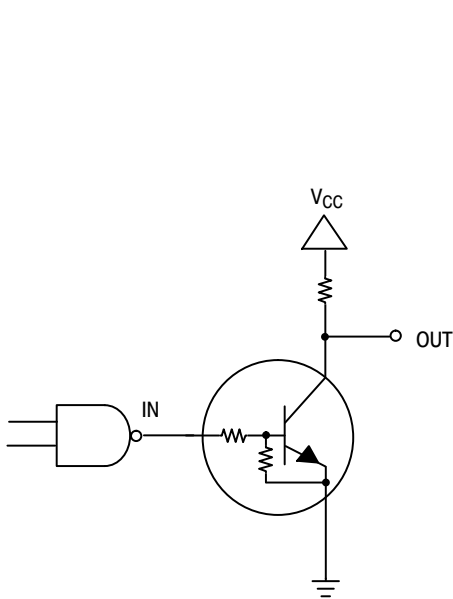

Figure 48. Open Collector Inverter: Inverts the Input Signal

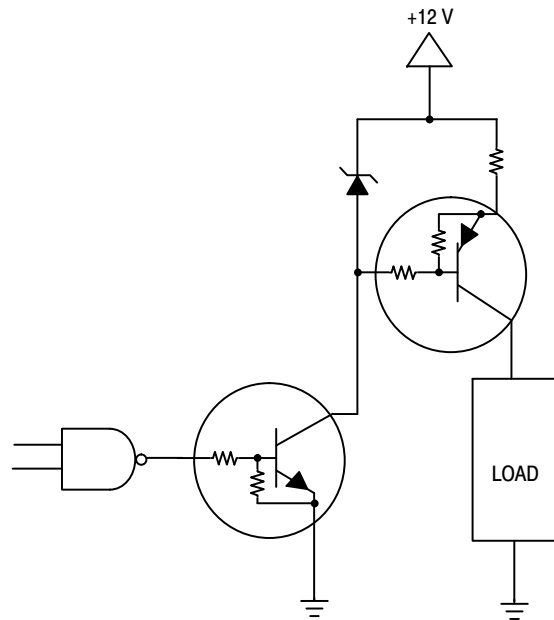
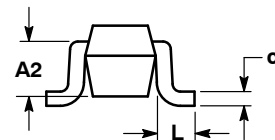
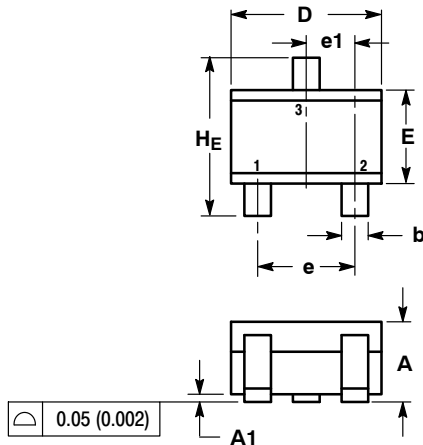

Figure 49. Inexpensive, Unregulated Current Source

MUN5211T1G Series, SMUN5211T1G Series

PACKAGE DIMENSIONS

SC-70 (SOT-323)
CASE 419-04
ISSUE N



NOTES:

1. DIMENSIONING AND TOLERANCING PER ANSI Y14.5M, 1982.
2. CONTROLLING DIMENSION: INCH.

DIM	MILLIMETERS			INCHES		
	MIN	NOM	MAX	MIN	NOM	MAX
A	0.80	0.90	1.00	0.032	0.035	0.040
A1	0.00	0.05	0.10	0.000	0.002	0.004
A2	0.70 REF			0.028 REF		
b	0.30	0.35	0.40	0.012	0.014	0.016
c	0.10	0.18	0.25	0.004	0.007	0.010
D	1.80	2.10	2.20	0.071	0.083	0.087
E	1.15	1.24	1.35	0.045	0.049	0.053
e	1.20	1.30	1.40	0.047	0.051	0.055
e1	0.65 BSC			0.026 BSC		
L	0.20	0.38	0.56	0.008	0.015	0.022
HE	2.00	2.10	2.40	0.079	0.083	0.095

STYLE 3:
PIN 1. BASE
2. EMITTER
3. COLLECTOR

SOLDERING FOOTPRINT*

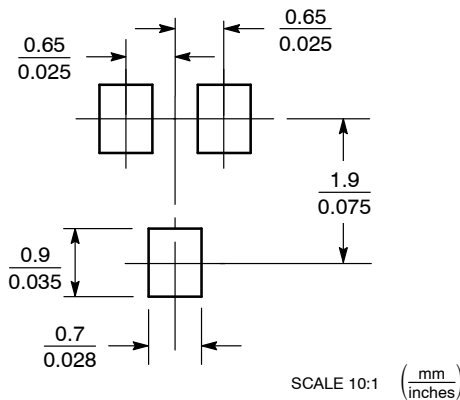

*For additional information on our Pb-Free strategy and soldering details, please download the ON Semiconductor Soldering and Mounting Techniques Reference Manual, SOLDERRM/D.

ON Semiconductor and are registered trademarks of Semiconductor Components Industries, LLC (SCILLC). SCILLC owns the rights to a number of patents, trademarks, copyrights, trade secrets, and other intellectual property. A listing of SCILLC's product/patent coverage may be accessed at www.onsemi.com/site/pdf/Patent-Marking.pdf. SCILLC reserves the right to make changes without further notice to any products herein. SCILLC makes no warranty, representation or guarantee regarding the suitability of its products for any particular purpose, nor does SCILLC assume any liability arising out of the application or use of any product or circuit, and specifically disclaims any and all liability, including without limitation special, consequential or incidental damages. "Typical" parameters which may be provided in SCILLC data sheets and/or specifications can and do vary in different applications and actual performance may vary over time. All operating parameters, including "Typicals" must be validated for each customer application by customer's technical experts. SCILLC does not convey any license under its patent rights nor the rights of others. SCILLC products are not designed, intended, or authorized for use as components in systems intended for surgical implant into the body, or other applications intended to support or sustain life, or for any other application in which the failure of the SCILLC product could create a situation where personal injury or death may occur. Should Buyer purchase or use SCILLC products for any such unintended or unauthorized application, Buyer shall indemnify and hold SCILLC and its officers, employees, subsidiaries, affiliates, and distributors harmless against all claims, costs, damages, and expenses, and reasonable attorney fees arising out of, directly or indirectly, any claim of personal injury or death associated with such unintended or unauthorized use, even if such claim alleges that SCILLC was negligent regarding the design or manufacture of the part. SCILLC is an Equal Opportunity/Affirmative Action Employer. This literature is subject to all applicable copyright laws and is not for resale in any manner.

PUBLICATION ORDERING INFORMATION

LITERATURE FULFILLMENT:
Literature Distribution Center for ON Semiconductor
P.O. Box 5163, Denver, Colorado 80217 USA
Phone: 303-675-2175 or 800-344-3860 Toll Free USA/Canada
Fax: 303-675-2176 or 800-344-3867 Toll Free USA/Canada
Email: orderlit@onsemi.com

N. American Technical Support: 800-282-9855 Toll Free
USA/Canada
Europe, Middle East and Africa Technical Support:
Phone: 421 33 790 2910
Japan Customer Focus Center
Phone: 81-3-5817-1050

ON Semiconductor Website: www.onsemi.com
Order Literature: <http://www.onsemi.com/orderlit>

For additional information, please contact your local Sales Representative

MUN5211T1/D