

Chip Inductors for RF Applications / Medical Applications (Wire wound-open)

FASTRON's wire wound chip inductors are designed for radio frequency (RF) applications that require optimal Q on high frequency circuits. Its gold flash pad metallization provides better solderability for a higher yield in production. Additionally, their encapsulation not only protects the winding but also allows for surface mount assembly. It comes in compact sizes (from 0402 to 1812) and is available in reel packaging. Unlisted inductance values are usually available upon request. Ferrite core versions are also available for selected case sizes for applications which require higher inductances in a smaller case size.

Applications Used in LC resonant circuits such as oscillator and signal generators, impedance matching, RF filters etc.
 Mobile Telecommunication: GSM, CDMA, TCDMA, cordless phones, 2 way radio
 Automotive Subsystems: TPMS, Keyless Entry, Anti-Theft, GPS
 Wireless Communication: W-LAN, WIFI, WIMAX, RFID, Bluetooth
 Non-magnetic versions for medical imaging applications: ASM series

Technical Data

L – Value (Rated Inductance)	≥ 1 MHz measured with HP 4286A RF LCR meter or equivalent at frequency f_L , 25°C ambient < 1 MHz measured with HP 4285A or equivalent at frequency f_L , 25°C ambient
Q – Factor (min)	≥ 1 MHz measured with E4991B Impedance Analyzer or equivalent at frequency f_Q , 25°C ambient < 1 MHz measured with HP 4285A or equivalent at frequency f_Q , 25°C ambient
SRF (min)	Measured with HP8753ES Network Analyzer or equivalent at 25°C ambient
DCR (max)	Measured at 25°C ambient
Rated DC Current: Irms	Max permissible current that causes a 15°C component temperature rise from 25°C ambient for AS, AQ, ASM & F Max permissible current that causes a 40°C component temperature rise from 25°C ambient for AQC & FLP
Saturation Current: Isat	Max permissible DC bias at 25°C ambient that causes inductivity drop 30% (typ.) related to the unloaded inductivity for FLP.
Operating Temperature	-40°C to +100°C (Including component self-heating): F -40°C to +125°C (Including component self-heating): FLP -40°C to +140°C (Including component self-heating): AS, AQ, ASM & AQC
Surface Finishing	Epoxy molded flat top for perfect pick and place assembly
Pad Metallization	Gold flash as top layer for AS, AQ, F & AF Silver-Palladium-Platinum for ASM & AQC Tin as top layer for FLP
Wire Termination	Spot welding
Recommended Soldering Method	Reflow
Moisture Sensitivity Levels (MSL)	MSL Level 1, indicating unlimited floor life at ≤ 30°C / 85% relative humidity
Solderability	Using lead free solder (Sn 99.9) at 260°C ± 5°C for 5 ± 0.5 seconds, min 90% solder coverage of metallization Standard: IEC 68-2-20 (Ta)
Resistance to Soldering Heat	Resistant to 260°C ± 5°C for 10 ± 1 seconds Standard: IEC 68-2-20 (Tb)
Resistance to Solvent	Resistant to isopropyl alcohol for 5 ± 0.5 minutes at 23°C ± 5°C Standard: IEC 68-2-45
Climatic Test	Defined by the following standards IEC 68-2-1 for Cold test: -55°C for 96 hours IEC 68-2-2 for Dry heat test: +85°C for ferrite core and 125°C for ceramic core for 96 hours IEC 60068-2-78 for Humidity test: 40°C at RH 95% for 4 days
Thermal Shock Test	Temperature cycle (ceramic): -40°C to +125°C to -40°C Temperature cycle (ferrite): -40°C to +85°C to -40°C Max/Min temperature duration: 15 minutes Temperature transition duration: 5 minutes Cycles: 25 Standard: MIL-STD-202G
Adhesion of Soldered Component (Shear Test)	Components withstand a pushing force of 10N for 10 ± 1 seconds Standard: IEC 60068-2-21, method Ue ₃
Mechanical Shock	Mil-Std 202 Method 213, Condition C 3 axis, 6 times, total 18 shocks 100 G, 6 ms, half-sine
Vibration	Mil-Std 202 Method 204 20 mins at 5G 10 Hz to 2000 Hz 12 cycles each of 3 orientations

Chip Inductors for RF Applications / Medical Applications (Wire wound-open)

Ordering Code Example : 0402AS-1N0X-YY → **0402AS-1N0K-01**

0402 AS - 1N0 X - YY
(Case Size) (Core Type) (Inductance Value) (Tolerance) (Packaging Code)

Case Sizes - 0402, 0603, 0805, 1008, 1206, 1210, 1812

Core Type - AS, AQ, AQC, ASM (Ceramic), F (Ferrite), AF (Ceramic & Ferrite), FLP (Ferrite Low Profile)

Tolerances - F (1%), G (2%), A (3%), J (5%), K (10%), L (15%), M (20%)

Packaging Code - 01, 04, 08 (Taped / Reel)

Packaging Specification Schematic

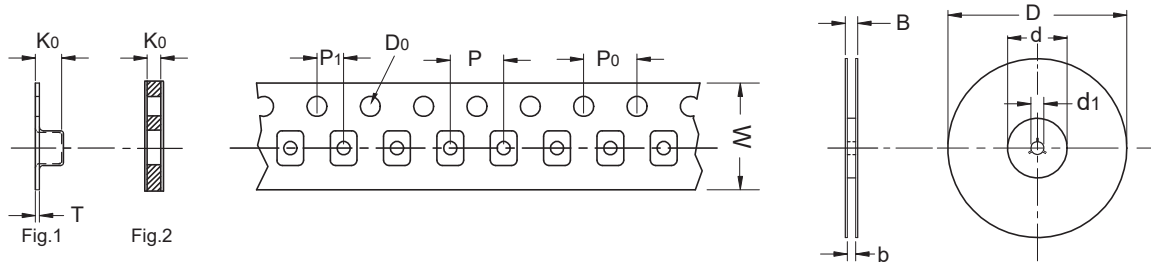

Type	Packaging Code	D	D0	d	d1	B	b	W	P	P0	P1	K0	T	Fig
0402	01,08	180	1.55	60	13	11.9	9.5	8	2	4	2	0.60	-	2
0603	01,08	180	1.55	60	13	11.4	9.0	8	4	4	2	0.98	-	2
0603	04	330	1.55	100	13	14.4	8.4	8	4	4	2	0.98	-	2
0805	01,08	180	1.55	60	13	11.4	9.0	8	4	4	2	1.63	0.25	1
0805	04	330	1.55	100	13	14.4	8.4	8	4	4	2	1.63	0.25	1
1008	01,08	180	1.50	60	13	11.4	9.5	8	4	4	2	2.23	0.30	1
1008	04	330	1.55	100	13	14.4	8.4	8	4	4	2	1.63	0.25	1
1206	01,08	180	1.50	60	13	18.4	13.7	12	4	4	2	1.80	0.30	1
1206	04	330	1.50	100	13	18.4	12.4	12	4	4	2	1.80	0.30	1
1210	01	180	1.55	60	13	18.4	13.7	12	8	4	2	2.55	0.30	1
1210	04	330	1.55	100	13	18.4	12.4	12	8	4	2	2.55	0.30	1
1812	01	180	1.50	60	13	18.4	13.7	12	8	4	2	3.70	0.35	1
1812	04	330	1.50	100	13	18.4	12.4	12	8	4	2	3.70	0.35	1

FASTRON's Component Key Characteristics



Approved according to AEC-Q200



Approved according to AEC-Q200 with High Temperature



Suitable for High Temperature



Part is RoHS conform and Halogen free



Mechanical Shock and Vibration Proof



Designed for High Q-values



Exceptionally High Q-values



Optimized for High Currents

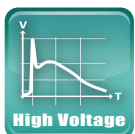

Optimized for High Voltages

1206 F

Engineer's Kit : EK-1206F-X

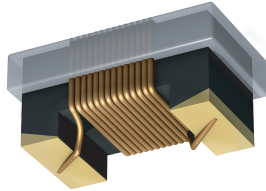

(Wire wound - open)

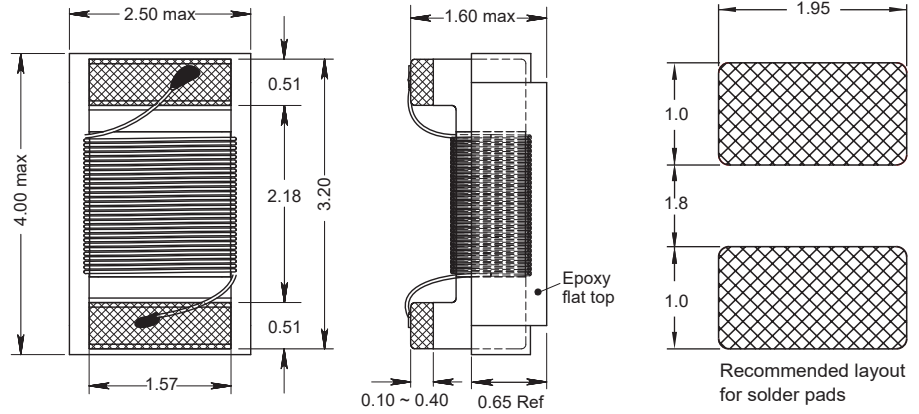

Chip Inductors for RF Applications

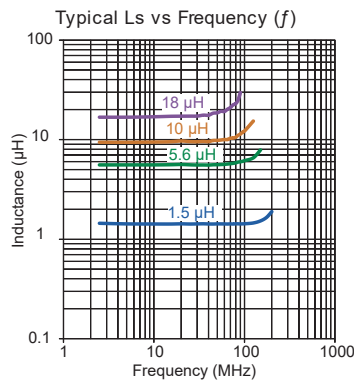
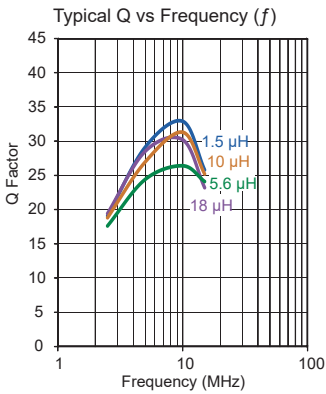
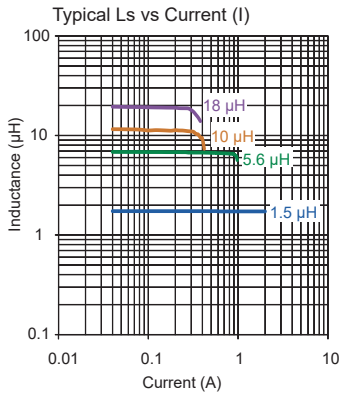

Part No	Inductance	f_L	Tol	Q	f_Q	SRF	DCR	Rated DC
	L (µH)	(MHz)	± (%)	min	(MHz)	(MHz)	max (Ω)	Current (mA)
1206F-1R0K-YY	1.0	7.9	10	25	7.9	300 min	0.98	350
1206F-1R5K-YY	1.5	7.9	10	25	7.9	240 min	1.2	320
1206F-1R8K-YY	1.8	7.9	10	25	7.9	200 min	1.2	320
1206F-2R2K-YY	2.2	7.9	10	25	7.9	200 min	1.3	300
1206F-2R7K-YY	2.7	7.9	10	25	7.9	190 min	1.4	300
1206F-3R3K-YY	3.3	7.9	10	25	7.9	160 min	1.5	280
1206F-3R9K-YY	3.9	7.9	10	25	7.9	160 min	1.9	280
1206F-4R7K-YY	4.7	7.9	10	25	7.9	140 typ	2.2	280
1206F-5R6K-YY	5.6	7.9	10	25	7.9	120 typ	2.4	260
1206F-6R8K-YY	6.8	7.9	10	25	7.9	110 typ	2.8	240
1206F-8R2K-YY	8.2	7.9	10	25	7.9	100 typ	3.1	220
1206F-100K-YY	10	7.9	10	25	7.9	100 typ	4.0	200
1206F-120K-YY	12	7.9	10	18	7.9	90 typ	4.6	200
* 1206F-150K-YY	15	2.5	10	16	2.5	75 typ	8.2	160
* 1206F-180K-YY	18	2.5	10	16	2.5	75 typ	9.0	130
1206F-470K-YY	47	2.5	10	18	2.5	25 typ	11.1	80
* 1206F-101K-YY	100	2.5	10	18	2.5	13 typ	21	80

Single layer (typ)

Core Material: Ferrite

Revision date: 11 Jan 2022

SPQ: Taped / Reel 1000 [-08]
2000 [-01]
7500 [-04]

Remarks: - Unlisted inductance values available upon request.
- 2% and 5% available upon request.
- All are AEC-Q200 Standard approved EXCEPT *.

Mouser Electronics

Authorized Distributor

Click to View Pricing, Inventory, Delivery & Lifecycle Information:

Fastron:

[1206F-6R8K-01](#) [1206F-4R7K-01](#) [1206F-3R9K-01](#) [1206F-100K-01](#) [1206F-120K-01](#) [1206F-150K-01](#) [1206F-1R5K-01](#)
[1206F-1R8K-01](#) [1206F-5R6K-01](#) [1206F-180K-01](#) [1206F-2R2K-01](#) [1206F-2R7K-01](#) [1206F-3R3K-01](#) [1206F-8R2K-](#)
[01](#) [1206F-180J-01](#) [1206F-100K-08](#) [1206F-101K-08](#) [1206F-120K-08](#) [1206F-150K-08](#) [1206F-180K-08](#) [1206F-1R0K-](#)
[08](#) [1206F-470K-08](#) [1206F-4R7K-08](#) [1206F-5R6K-08](#) [1206F-6R8K-08](#) [1206F-8R2K-08](#) [1206F-1R5K-08](#) [1206F-](#)
[1R8K-08](#) [1206F-2R2K-08](#) [1206F-2R7K-08](#) [1206F-3R3K-08](#) [1206F-3R9K-08](#) [1206F-101J-08](#) [1206F-5R6G-01](#)
[1206F-3R3G-04](#) [1206F-6R8G-01](#) [1206F-1R0J-08](#) [1206F-101G-01](#) [1206F-3R9G-01](#) [1206F-4R7J-08](#) [1206F-2R2J-08](#)
[1206F-150J-08](#) [1206F-8R2G-04](#) [1206F-1R5G-04](#) [1206F-4R7J-01](#) [1206F-4R7J-04](#) [1206F-1R0K-04](#) [1206F-150J-04](#)
[1206F-150K-04](#) [1206F-8R2G-08](#) [1206F-3R3J-01](#) [1206F-4R7G-04](#) [1206F-470K-01](#) [1206F-180G-08](#) [1206F-2R7K-](#)
[04](#) [1206F-8R2G-01](#) [1206F-1R5G-08](#) [1206F-1R8G-04](#) [1206F-3R9G-08](#) [1206F-6R8G-08](#) [1206F-470K-04](#) [1206F-](#)
[3R3G-01](#) [1206F-120J-04](#) [1206F-2R2G-01](#) [1206F-100J-01](#) [1206F-2R7G-04](#) [1206F-1R5G-01](#) [1206F-1R8J-04](#)
[1206F-100G-04](#) [1206F-100K-04](#) [1206F-120K-04](#) [1206F-6R8J-01](#) [1206F-120G-08](#) [1206F-150J-01](#) [1206F-6R8K-04](#)
[1206F-2R2K-04](#) [1206F-470J-01](#) [1206F-100G-01](#) [1206F-2R7J-08](#) [1206F-470J-04](#) [1206F-120G-01](#) [1206F-1R0G-08](#)
[1206F-2R7J-04](#) [1206F-150G-01](#) [1206F-1R5K-04](#) [1206F-3R9J-08](#) [1206F-2R7G-08](#) [1206F-100J-04](#) [1206F-6R8J-04](#)
[1206F-470G-04](#) [1206F-5R6K-04](#) [1206F-5R6J-04](#) [1206F-2R2J-01](#) [1206F-180K-04](#) [1206F-3R9K-04](#) [1206F-1R0J-01](#)
[1206F-3R3J-04](#) [1206F-2R2G-04](#) [1206F-2R2J-04](#) [1206F-1R8G-08](#)