

50V NPN SILICON LOW SATURATION TRANSISTOR IN SOT23

Features and Benefits

- $BV_{CE0} > 50V$
- $I_C = 2A$ Continuous Collector Current
- Low Saturation Voltage $V_{CE(sat)} < 200mV @ 1A$
- $R_{SAT} = 68m\Omega$ for a low equivalent on-resistance
- h_{FE} characterised up to 6A for high current gain hold-up
- 625mW power dissipation due to SuperSOT package
- Complementary NPN type: FMMT720
- **Totally Lead-Free & Fully RoHS compliant (Notes 1 & 2)**
- **Halogen and Antimony Free. "Green" Device (Note 3)**
- **Qualified to AEC-Q101 Standards for High Reliability**

Mechanical Data

- Case: SOT23
- Case material: Molded Plastic. "Green" Molding Compound
- UL Flammability Classification Rating 94V-0
- Moisture Sensitivity: Level 1 per J-STD-020
- Terminals: Matte Tin Finish annealed over Copper plated Alloy 42 leadframe. Solderable per MIL-STD-202, Method 208 ③
- Weight: 0.008 grams (Approximate)

Applications

- MOSFET Gate Driving
- DC-DC / DC-AC Converters
- Regulator
- LED driver
- Motor Control

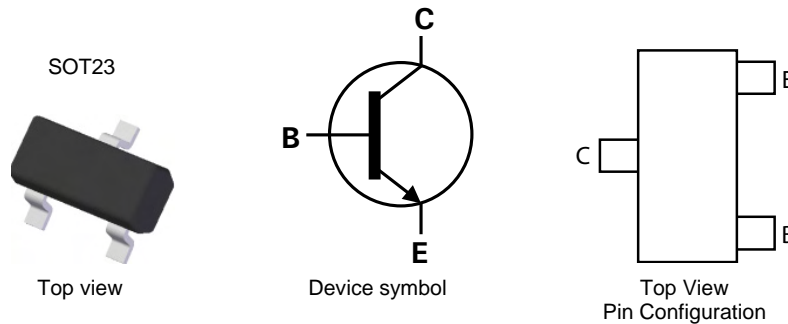

Ordering Information (Note 4)

| Product | Marking | Reel size (inches) | Tape width (mm) | Quantity per reel |
|-----------|---------|--------------------|-----------------|-------------------|
| FMMT619TA | 619 | 7 | 8 | 3,000 |
| FMMT619TC | 619 | 13 | 8 | 10,000 |

- Notes:
1. No purposely added lead. Fully EU Directive 2002/95/EC (RoHS) & 2011/65/EU (RoHS 2) compliant.
 2. See <http://www.diodes.com/> for more information about Diodes Incorporated's definitions of Halogen and Antimony free, "Green" and Lead-Free.
 3. Halogen and Antimony free "Green" products are defined as those which contain <900ppm bromine, <900ppm chlorine (<1500ppm total Br + Cl) and <1000ppm antimony compounds.
 4. For packaging details, go to our website at <http://www.diodes.com>

Marking Information

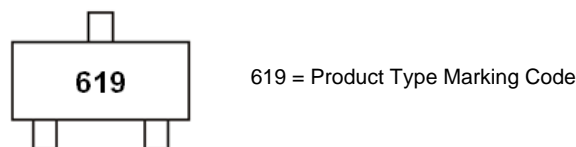

Maximum Ratings @T_A = 25°C unless otherwise specified

| Characteristic | Symbol | Value | Unit |
|------------------------------|------------------|-------|------|
| Collector-Base Voltage | V _{CB0} | 50 | V |
| Collector-Emitter Voltage | V _{CEO} | 50 | V |
| Emitter-Base Voltage | V _{EBO} | 7 | V |
| Continuous Collector Current | I _C | 2 | A |
| Peak Pulse Current | I _{CM} | 6 | A |
| Base Current | I _B | 500 | mA |

Thermal Characteristics @T_A = 25°C unless otherwise specified

| Characteristic | Symbol | Value | Unit |
|---|-----------------------------------|-------------|-------|
| Power Dissipation | P _D | 625 | mW |
| Linear Rating Factor | | 5 | mW/°C |
| Thermal Resistance, Junction to Ambient | R _{θJA} | 200 | °C/W |
| Thermal Resistance, Junction to Lead | R _{θJL} | 194 | °C/W |
| Operating and Storage Temperature Range | T _J , T _{STG} | -55 to +150 | °C |

Notes: 5. For a device surface mounted on 25mm X 25mm FR4 PCB with high coverage of single sided 1 oz copper, in still air conditions; the device is measured when operating in a steady-state condition.
6. Thermal resistance from junction to solder-point (at the end of the collector lead).

Thermal Characteristics and Derating information

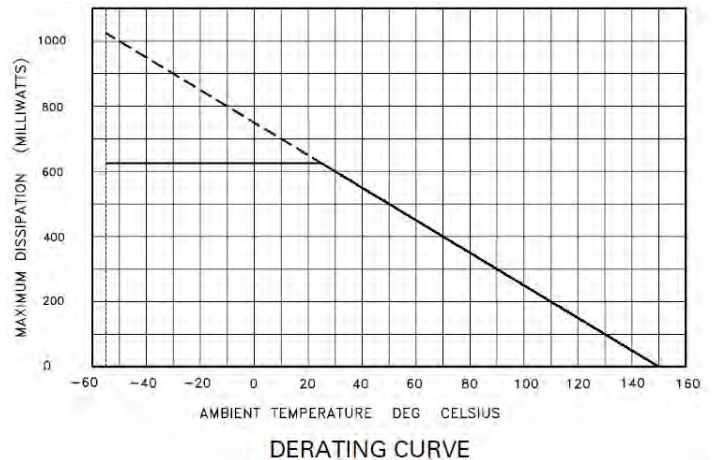
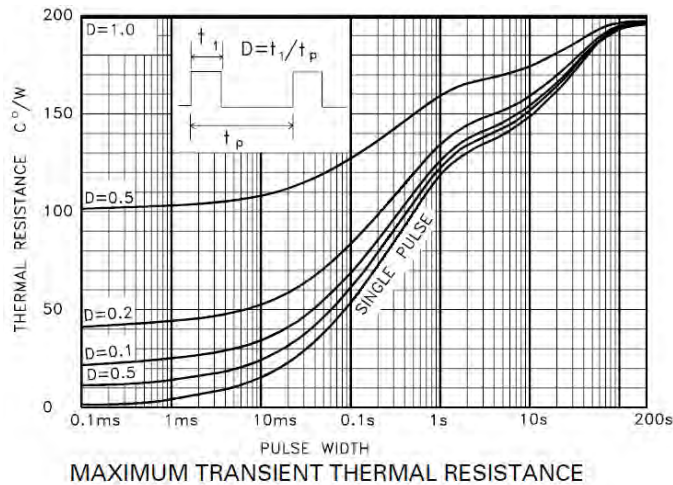

Electrical Characteristics @ $T_A = 25^\circ\text{C}$ unless otherwise specified

| Characteristic | Symbol | Min | Typ | Max | Unit | Test Condition |
|--|---------------|-----|------|-----|------|---|
| OFF CHARACTERISTICS | | | | | | |
| Collector-Base Breakdown Voltage | BV_{CBO} | 50 | 190 | - | V | $I_C = 100\mu\text{A}$ |
| Collector-Emitter Breakdown Voltage (Note 7) | BV_{CEO} | 50 | 65 | - | V | $I_C = 10\text{mA}$ |
| Emitter-Base Breakdown Voltage | BV_{EBO} | 7 | 8.3 | - | V | $I_E = 100\mu\text{A}$ |
| Collector Cut-off Current | I_{CBO} | - | - | 100 | nA | $V_{CB} = 40\text{V}$ |
| Emitter Cut-off Current | I_{EBO} | - | - | 100 | nA | $V_{EB} = 6\text{V}$ |
| Collector Emitter Cut-off Current | I_{CES} | - | - | 100 | nA | $V_{CES} = 40\text{V}$ |
| ON CHARACTERISTICS (Note 7) | | | | | | |
| Static Forward Current Transfer Ratio | h_{FE} | 200 | 400 | - | - | $I_C = 10\text{mA}, V_{CE} = 2\text{V}$ |
| | | 300 | 450 | - | | |
| | | 200 | 400 | - | | |
| | | 100 | 225 | - | | |
| | | - | 40 | - | | |
| Collector-Emitter Saturation Voltage | $V_{CE(sat)}$ | - | 10 | 20 | mV | $I_C = 0.1\text{A}, I_B = 10\text{mA}$ |
| | | - | 125 | 200 | | $I_C = 1\text{A}, I_B = 10\text{mA}$ |
| | | - | 150 | 220 | | $I_C = 2\text{A}, I_B = 50\text{mA}$ |
| Base-Emitter Saturation Voltage | $V_{BE(sat)}$ | - | 0.87 | 1.0 | V | $I_C = 2\text{A}, I_B = 50\text{mA}$ |
| Base-Emitter Saturation Voltage | $V_{BE(on)}$ | - | 0.80 | 1.0 | V | $I_C = 2\text{A}, V_{CE} = 2\text{V}$ |
| SMALL SIGNAL CHARACTERISTICS | | | | | | |
| Transition Frequency | f_T | 100 | 165 | - | MHz | $I_C = 50\text{mA}, V_{CE} = 10\text{V}, f = 100\text{MHz}$ |
| Collector Output Capacitance | C_{obo} | - | 12 | 20 | pF | $V_{CB} = 10\text{V}, f = 1\text{MHz}$ |
| Turn-On Time | $t_{(on)}$ | - | 170 | - | ns | $V_{CC} = 10\text{V}, I_C = 1\text{A},$ |
| Turn-Off Time | $t_{(off)}$ | - | 750 | - | ns | $I_{B1} = -I_{B2} = 10\text{mA}$ |

Notes: 7. Measured under pulsed conditions. Pulse width $\leq 300\mu\text{s}$. Duty cycle $\leq 2\%$

Typical Electrical Characteristics

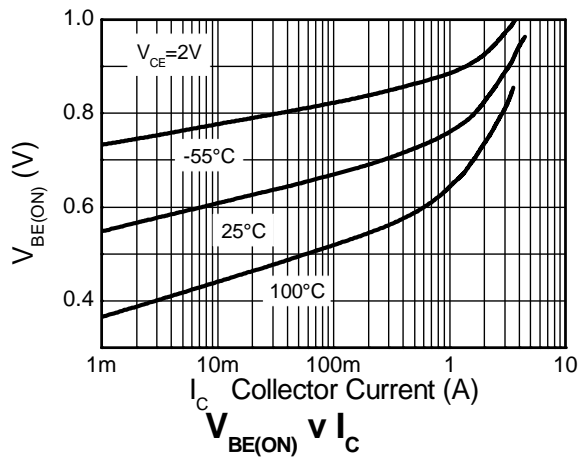
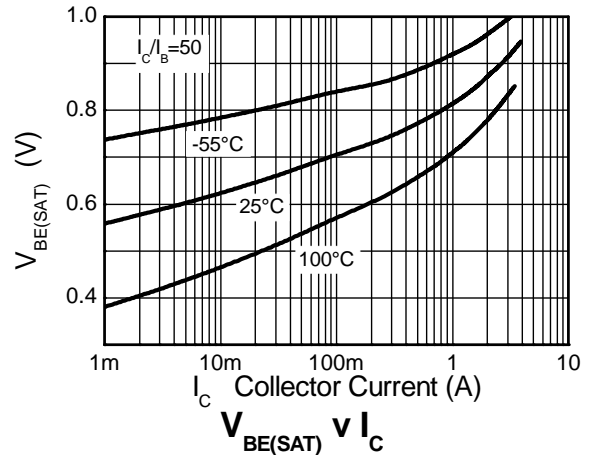
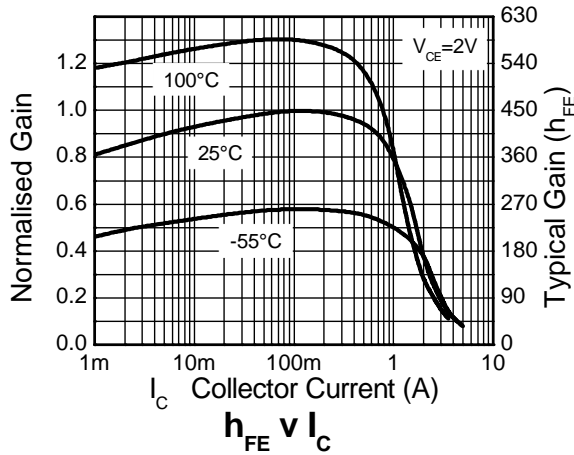
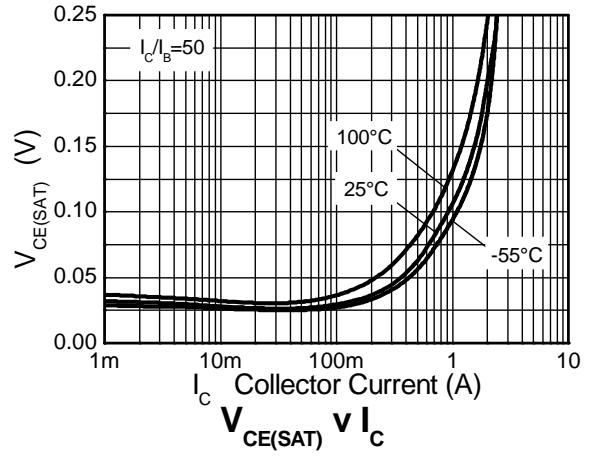
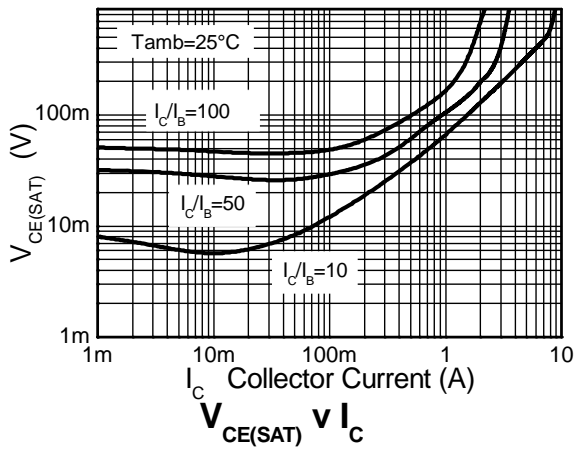

Package Outline Dimensions

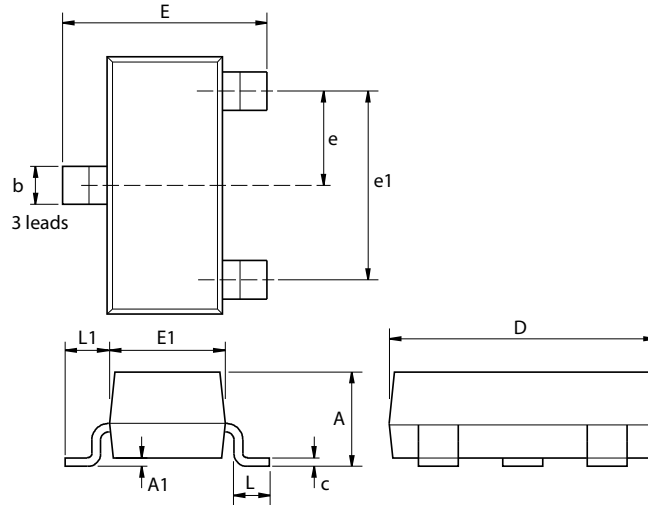

| Dim. | Millimeters | | Inches | | Dim. | Millimeters | | Inches | |
|------|-------------|------|-----------|-------|------|-------------|------|-----------|--------|
| | Min. | Max. | Min. | Max. | | Min. | Max. | Min. | Max. |
| A | - | 1.12 | - | 0.044 | e1 | 1.90 NOM | | 0.075 NOM | |
| A1 | 0.01 | 0.10 | 0.0004 | 0.004 | E | 2.10 | 2.64 | 0.083 | 0.104 |
| b | 0.30 | 0.50 | 0.012 | 0.020 | E1 | 1.20 | 1.40 | 0.047 | 0.055 |
| c | 0.085 | 0.20 | 0.003 | 0.008 | L | 0.25 | 0.60 | 0.0098 | 0.0236 |
| D | 2.80 | 3.04 | 0.110 | 0.120 | L1 | 0.45 | 0.62 | 0.018 | 0.024 |
| e | 0.95 NOM | | 0.037 NOM | | - | - | - | - | - |

Note: Controlling dimensions are in millimeters. Approximate dimensions are provided in inches

Suggested Pad Layout

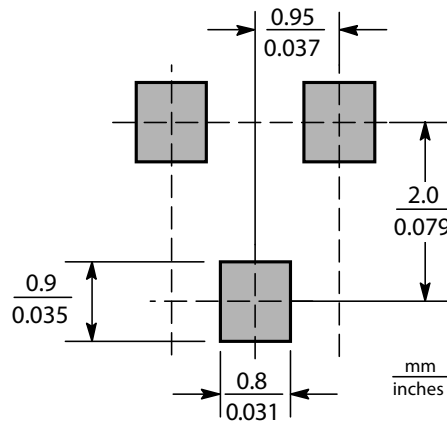

IMPORTANT NOTICE

DIODES INCORPORATED MAKES NO WARRANTY OF ANY KIND, EXPRESS OR IMPLIED, WITH REGARDS TO THIS DOCUMENT, INCLUDING, BUT NOT LIMITED TO, THE IMPLIED WARRANTIES OF MERCHANTABILITY AND FITNESS FOR A PARTICULAR PURPOSE (AND THEIR EQUIVALENTS UNDER THE LAWS OF ANY JURISDICTION).

Diodes Incorporated and its subsidiaries reserve the right to make modifications, enhancements, improvements, corrections or other changes without further notice to this document and any product described herein. Diodes Incorporated does not assume any liability arising out of the application or use of this document or any product described herein; neither does Diodes Incorporated convey any license under its patent or trademark rights, nor the rights of others. Any Customer or user of this document or products described herein in such applications shall assume all risks of such use and will agree to hold Diodes Incorporated and all the companies whose products are represented on Diodes Incorporated website, harmless against all damages.

Diodes Incorporated does not warrant or accept any liability whatsoever in respect of any products purchased through unauthorized sales channel. Should Customers purchase or use Diodes Incorporated products for any unintended or unauthorized application, Customers shall indemnify and hold Diodes Incorporated and its representatives harmless against all claims, damages, expenses, and attorney fees arising out of, directly or indirectly, any claim of personal injury or death associated with such unintended or unauthorized application.

Products described herein may be covered by one or more United States, international or foreign patents pending. Product names and markings noted herein may also be covered by one or more United States, international or foreign trademarks.

LIFE SUPPORT

Diodes Incorporated products are specifically not authorized for use as critical components in life support devices or systems without the express written approval of the Chief Executive Officer of Diodes Incorporated. As used herein:

A. Life support devices or systems are devices or systems which:

1. are intended to implant into the body, or
2. support or sustain life and whose failure to perform when properly used in accordance with instructions for use provided in the labeling can be reasonably expected to result in significant injury to the user.

B. A critical component is any component in a life support device or system whose failure to perform can be reasonably expected to cause the failure of the life support device or to affect its safety or effectiveness.

Customers represent that they have all necessary expertise in the safety and regulatory ramifications of their life support devices or systems, and acknowledge and agree that they are solely responsible for all legal, regulatory and safety-related requirements concerning their products and any use of Diodes Incorporated products in such safety-critical, life support devices or systems, notwithstanding any devices- or systems-related information or support that may be provided by Diodes Incorporated. Further, Customers must fully indemnify Diodes Incorporated and its representatives against any damages arising out of the use of Diodes Incorporated products in such safety-critical, life support devices or systems.

Copyright © 2012, Diodes Incorporated

www.diodes.com

Mouser Electronics

Authorized Distributor

Click to View Pricing, Inventory, Delivery & Lifecycle Information:

[Diodes Incorporated:](#)

[FMMT619TC](#)