

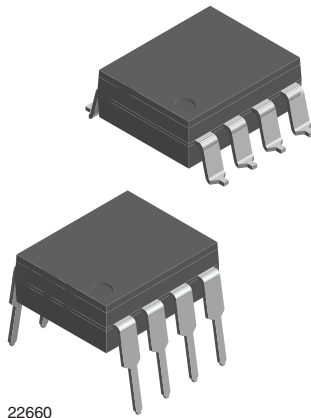

# Widebody, High Isolation, High Speed Optocoupler, 1 MBd

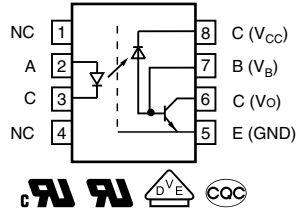

22660



## DESCRIPTION

1 MBd widebody optocouplers consist of a GaAlAs infrared emitting diode, optically coupled with an integrated photo detector. An integral Faraday shield provides a high level of noise isolation, required by high power switching applications.

Vishay's 1 MBd wide body couplers feature a high level of isolation distance, exhibiting an external creepage distance of > 10 mm. This makes these parts ideal for applications with working voltages exceeding 1000 V.

## FEATURES

- External creepage > 10 mm
- Reinforced isolation
- Internal shield for very high input to output noise isolation
- High common mode interference immunity
- Material categorization: for definitions of compliance please see [www.vishay.com/doc?99912](http://www.vishay.com/doc?99912)



**RoHS**  
 COMPLIANT  
 HALOGEN  
**FREE**  
**GREEN**  
 (5-2008)

## APPLICATIONS

- Solar inverters
- Industrial motor drives
- Welding equipment
- Isolated industrial communications
- Noise isolation of sensitive circuits

## AGENCY APPROVALS

The safety application model number covering all products in this datasheet is VOW135 or VOW136 respectively. This model number should be used when consulting safety agency documents.

- UL1577
- cUL
- DIN EN 60747-5-5 (VDE 0884-5)
- CQC

ORDERING INFORMATION		
<div style="display: flex; justify-content: space-around; align-items: center;"> <div style="border: 1px solid black; padding: 2px 5px;">V</div> <div style="border: 1px solid black; padding: 2px 5px;">O</div> <div style="border: 1px solid black; padding: 2px 5px;">W</div> <div style="border: 1px solid black; padding: 2px 5px;">1</div> <div style="border: 1px solid black; padding: 2px 5px;">3</div> <div style="border: 1px solid black; padding: 2px 5px;">#</div> <div style="border: 1px solid black; padding: 2px 5px;">-</div> <div style="border: 1px solid black; padding: 2px 5px;">X</div> <div style="border: 1px solid black; padding: 2px 5px;">0</div> <div style="border: 1px solid black; padding: 2px 5px;">#</div> <div style="border: 1px solid black; padding: 2px 5px;">#</div> <div style="border: 1px solid black; padding: 2px 5px;">T</div> </div> <p style="text-align: center;"> <span style="margin-right: 100px;">PART NUMBER</span> <span style="margin-right: 100px;">PACKAGE OPTION</span> <span>TAPE AND REEL</span> </p>		
AGENCY CERTIFIED/PACKAGE	CTR (%)	
VDE, UL, cUL, CQC	≥ 7	≥ 19
DIP-8, 400 mil, widebody	VOW135-X001	VOW136-X001
SMD-8, 400 mil, option 7, widebody	VOW135-X017T	VOW136-X017T



<b>ABSOLUTE MAXIMUM RATINGS</b> ( $T_{amb} = 25\text{ }^{\circ}\text{C}$ , unless otherwise specified)				
PARAMETER	CONDITIONS	SYMBOL	VALUE	UNIT
<b>INPUT</b>				
Reverse voltage		$V_R$	3	V
Forward current		$I_F$	25	mA
Peak forward current	$t = 1\text{ ms}$ , duty cycle 50 %	$I_{FM}$	50	mA
Maximum surge forward current	$t \leq 1\text{ }\mu\text{s}$ , 300 pulses/s	$I_{FSM}$	1	A
Power dissipation		$P_{diss}$	45	mW
Input junction temperature		$T_{j\text{ max.}}$	125	$^{\circ}\text{C}$
<b>OUTPUT</b>				
Supply voltage		$V_S$	-0.5 to 30	V
Output voltage		$V_O$	-0.5 to 25	V
Emitter base voltage		$V_{EBO}$	5	V
Average output current		$I_O$	8	mA
Peak output current		$I_O$	16	mA
Base current		$I_B$	5	mA
Power dissipation		$P_{diss}$	100	mW
Output junction temperature		$T_{j\text{ max.}}$	125	$^{\circ}\text{C}$
<b>COUPLER</b>				
Storage temperature range		$T_{stg}$	-55 to +150	$^{\circ}\text{C}$
Ambient temperature range		$T_{amb}$	-40 to +100	$^{\circ}\text{C}$
Soldering temperature	max. $\leq 10\text{ s}$ , dip soldering $\geq 0.5\text{ mm}$ distance from case bottom	$T_{sld}$	260	$^{\circ}\text{C}$

**Notes**

- Stresses in excess of the absolute maximum ratings can cause permanent damage to the device. Functional operation of the device is not implied at these or any other conditions in excess of those given in the operational sections of this document. Exposure to absolute maximum ratings for extended periods of the time can adversely affect reliability.

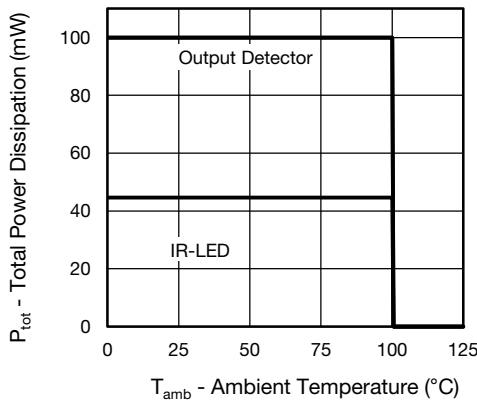

Fig. 1 - Maximum Power vs. Operating Temperature

<b>ELECTRICAL CHARACTERISTICS</b> ( $T_{amb} = 0\text{ }^{\circ}\text{C}$ to $70\text{ }^{\circ}\text{C}$ , unless otherwise specified)							
PARAMETER	TEST CONDITION	PART	SYMBOL	MIN.	TYP.	MAX.	UNIT
<b>INPUT</b>							
Forward voltage	$I_F = 16\text{ mA}$		$V_F$		1.38	1.9	V
Breakdown voltage	$I_R = 10\text{ }\mu\text{A}$		$V_{BR}$	3			V
Reverse current	$V_R = 3\text{ V}$		$I_R$		0.5	10	$\mu\text{A}$
Input capacitance	$V_R = 0\text{ V}$ , $f = 1\text{ MHz}$		$C_I$		36		pF
Temperature coefficient of forward voltage	$I_F = 16\text{ mA}$		$\Delta V_F/\Delta T_{amb}$		-1.9		mV/ $^{\circ}\text{C}$
<b>OUTPUT</b>							
Logic low supply current	$I_F = 16\text{ mA}$ , $V_O = \text{open}$ , $V_{CC} = 15\text{ V}$		$I_{CCL}$		50	200	$\mu\text{A}$
Logic high supply current	$I_F = 0\text{ A}$ , $V_O = \text{open}$ , $V_{CC} = 15\text{ V}$		$I_{CCH}$		0.02	2	$\mu\text{A}$
Output voltage, output logic low	$I_F = 16\text{ mA}$ , $V_{CC} = 4.5\text{ V}$ , $I_O = 0.8\text{ mA}$	VOW135	$V_{OL}$		0.1	0.5	V
	$I_F = 16\text{ mA}$ , $V_{CC} = 4.5\text{ V}$ , $I_O = 2.4\text{ mA}$	VOW136	$V_{OL}$		0.1	0.5	V
Output current, output logic high	$I_F = 0\text{ mA}$ , $V_O = V_{CC} = 5.5\text{ V}$		$I_{OH}$		3	500	nA
	$I_F = 0\text{ mA}$ , $V_O = V_{CC} = 15\text{ V}$		$I_{OH}$		0.01	1	$\mu\text{A}$
Output capacitance	$V_R = 0\text{ V}$ , $f = 1\text{ MHz}$		$C_O$		3.70		pF
<b>COUPLER</b>							
Capacitance (input to output)	$f = 1\text{ MHz}$		$C_{IO}$		0.9		pF

**Note**

- Minimum and maximum values are testing requirements. Typical values are characteristics of the device and are the result of engineering evaluation. Typical values are for information only and are not part of the testing requirements.

<b>CURRENT TRANSFER RATIO</b> ( $T_{amb} = 0\text{ }^{\circ}\text{C}$ to $70\text{ }^{\circ}\text{C}$ , unless otherwise specified)							
PARAMETER	TEST CONDITION	PART	SYMBOL	MIN.	TYP.	MAX.	UNIT
Current transfer ratio	$I_F = 16\text{ mA}$ , $V_O = 0.4\text{ V}$ , $V_{CC} = 4.5\text{ V}$ , $T_{amb} = 25\text{ }^{\circ}\text{C}$	VOW135	CTR	7	18	50	%
		VOW136	CTR	19	24	50	%
	$I_F = 16\text{ mA}$ , $V_O = 0.5\text{ V}$ , $V_{CC} = 4.5\text{ V}$	VOW135	CTR	5	19		%
		VOW136	CTR	15	25		%

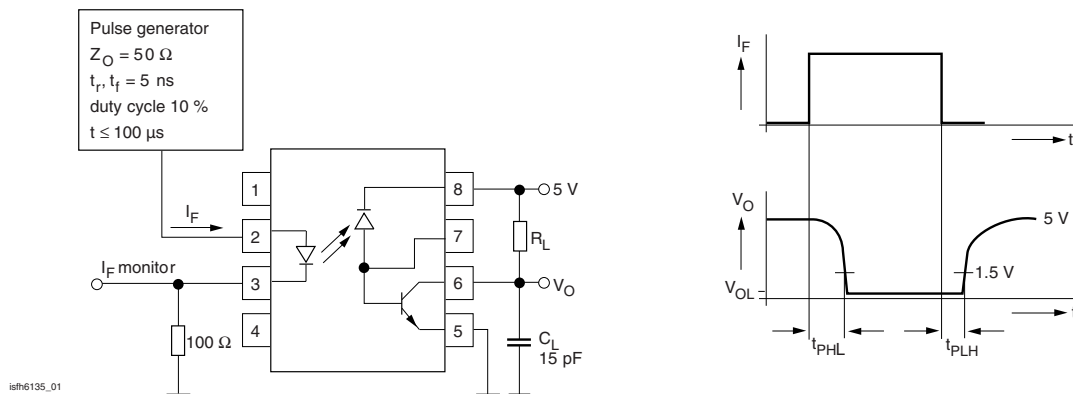

Fig. 2 - Schematics

<b>SWITCHING CHARACTERISTICS</b> ( $T_{amb} = 0\text{ }^{\circ}\text{C}$ to $70\text{ }^{\circ}\text{C}$ , unless otherwise specified)							
PARAMETER	TEST CONDITION	PART	SYMBOL	MIN.	TYP.	MAX.	UNIT
High to low	$I_F = 16\text{ mA}$ , $V_{CC} = 5\text{ V}$ , $R_L = 4.1\text{ k}\Omega$	VOW135	$t_{PHL}$		0.2	2.0	$\mu\text{s}$
	$I_F = 16\text{ mA}$ , $V_{CC} = 5\text{ V}$ , $R_L = 1.9\text{ k}\Omega$	VOW136	$t_{PHL}$		0.2	1.0	$\mu\text{s}$
Low to high	$I_F = 16\text{ mA}$ , $V_{CC} = 5\text{ V}$ , $R_L = 4.1\text{ k}\Omega$	VOW135	$t_{PLH}$		1.3	2.0	$\mu\text{s}$
	$I_F = 16\text{ mA}$ , $V_{CC} = 5\text{ V}$ , $R_L = 1.9\text{ k}\Omega$	VOW136	$t_{PLH}$		0.6	1.0	$\mu\text{s}$

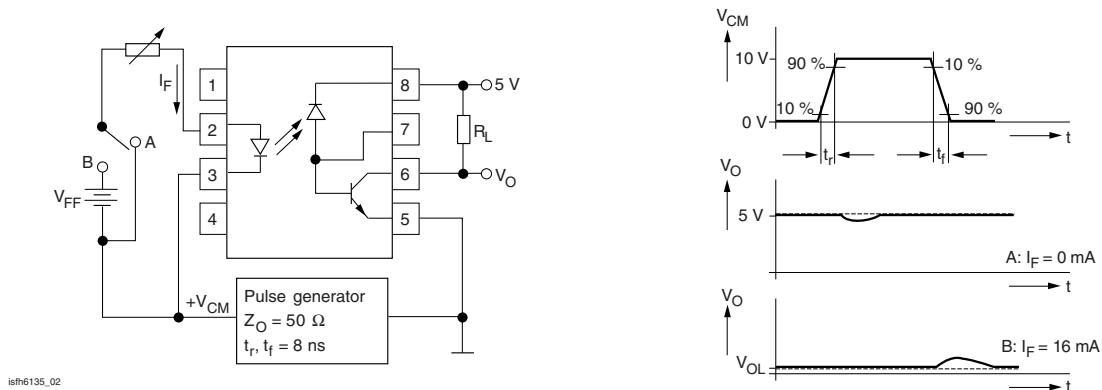

Fig. 3 - Common Mode Interference Immunity

<b>COMMON MODE TRANSIENT IMMUNITY</b> ( $T_{amb} = 0\text{ }^{\circ}\text{C}$ to $70\text{ }^{\circ}\text{C}$ , unless otherwise specified)							
PARAMETER	TEST CONDITION	PART	SYMBOL	MIN.	TYP.	MAX.	UNIT
High	$V_{CM} = 10\text{ V}_{PP}$ , $V_{CC} = 5\text{ V}$ , $I_F = 0\text{ mA}$ , $R_L = 4.1\text{ k}\Omega$	VOW135	$CM_H$	1000			$\text{V}/\mu\text{s}$
	$V_{CM} = 10\text{ V}_{PP}$ , $V_{CC} = 5\text{ V}$ , $I_F = 0\text{ mA}$ , $R_L = 1.9\text{ k}\Omega$	VOW136	$CM_H$	1000			$\text{V}/\mu\text{s}$
Low	$V_{CM} = 10\text{ V}_{PP}$ , $V_{CC} = 5\text{ V}$ , $I_F = 16\text{ mA}$ , $R_L = 4.1\text{ k}\Omega$	VOW135	$CM_L$	1000			$\text{V}/\mu\text{s}$
	$V_{CM} = 10\text{ V}_{PP}$ , $V_{CC} = 5\text{ V}$ , $I_F = 16\text{ mA}$ , $R_L = 1.9\text{ k}\Omega$	VOW136	$CM_L$	1000			$\text{V}/\mu\text{s}$

<b>SAFETY AND INSULATION RATINGS</b>				
PARAMETER		SYMBOL	VALUE	UNIT
Climatic classification (according to IEC 68 part 1)			55/100/21	
Comparative tracking index		CTI	250	
Maximum rated withstanding isolation voltage	$t = 1\text{ min}$	$V_{ISO}$	5300	$V_{RMS}$
Maximum transient isolation voltage		$V_{IOTM}$	8000	$V_{peak}$
Maximum repetitive peak isolation voltage		$V_{IORM}$	1414	$V_{peak}$
Insulation resistance	$T_{amb} = 25\text{ }^{\circ}\text{C}$ , $V_{DC} = 500\text{ V}$	$R_{IO}$	$\geq 10^{12}$	$\Omega$
	$T_{amb} = 100\text{ }^{\circ}\text{C}$ , $V_{DC} = 500\text{ V}$	$R_{IO}$	$\geq 10^{11}$	$\Omega$
Output safety power		$P_{SO}$	700	mW
Input safety current		$I_{SI}$	400	mA
Safety temperature		$T_S$	150	$^{\circ}\text{C}$
Clearance distance (DIP-8, widebody)			$\geq 10$	mm
Creepage distance (DIP-8, widebody)			$\geq 10$	mm
Insulation thickness		DTI	$\geq 0.4$	mm
Input to output test voltage, method B	$V_{IORM} \times 1.875 = V_{PR}$ , 100 % production test with $t_M = 1\text{ s}$ , partial discharge $< 5\text{ pC}$	$V_{PR}$	2651	$V_{peak}$
Input to output test voltage, method A	$V_{IORM} \times 1.6 = V_{PR}$ , 100 % production test with $t_M = 10\text{ s}$ , partial discharge $< 5\text{ pC}$	$V_{PR}$	2262	$V_{peak}$
Environment (pollution degree in accordance to DIN VDE 0109)			2	

**Note**

- As per DIN EN 60747-5-5, § 7.4.3.8.2, this optocoupler is suitable for “safe electrical insulation” only within the safety ratings. Compliance with the safety ratings shall be ensured by means of protective circuits.



**TYPICAL CHARACTERISTICS** ( $T_{amb} = 25\text{ }^{\circ}\text{C}$ , unless otherwise specified)

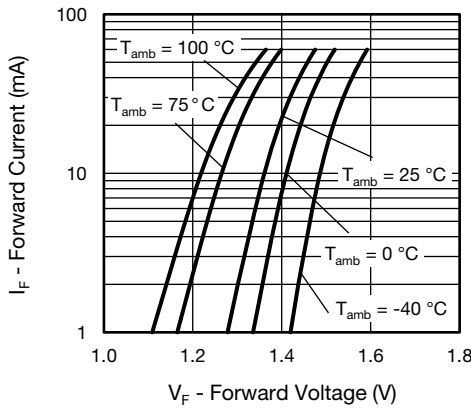

Fig. 4 - Output Current vs. Forward Voltage

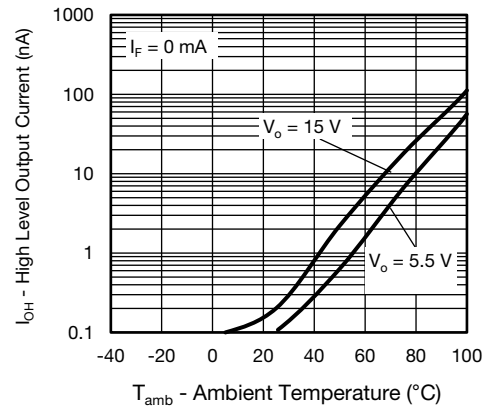

Fig. 7 - Logic High Level Output Current vs. Temperature

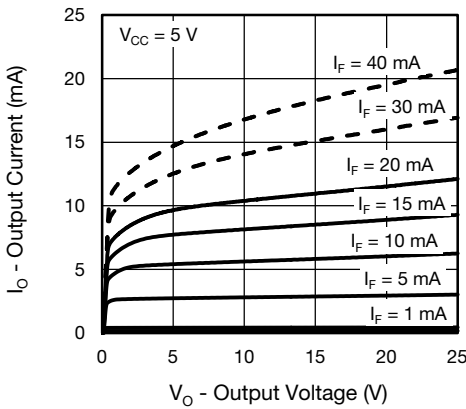

Fig. 5 - Output Current vs. Output Voltage

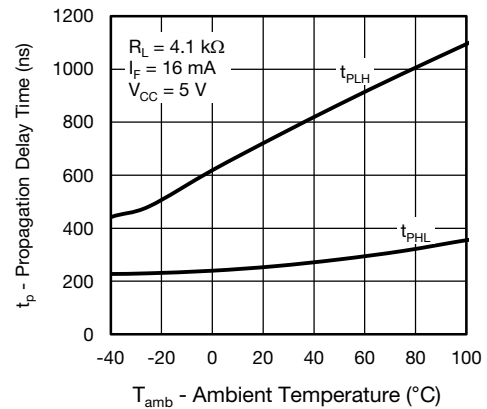

Fig. 8 - Propagation Delay vs. Ambient Temperature - VOW135

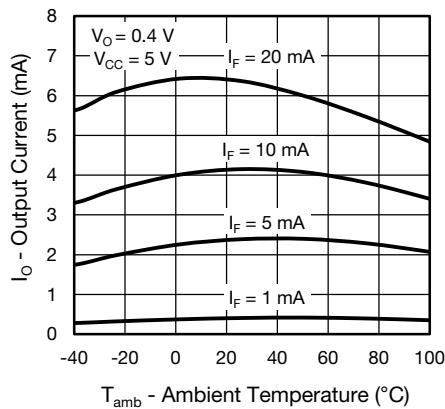

Fig. 6 - Output Current vs. Temperature

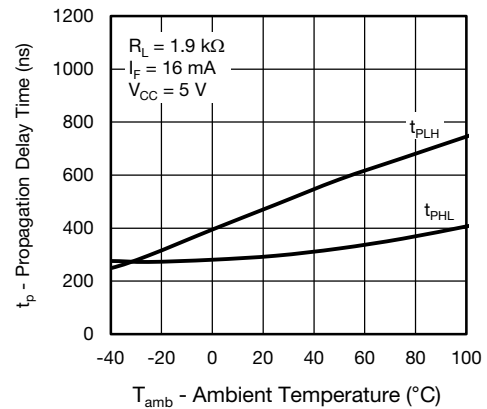

Fig. 9 - Propagation Delay vs. Ambient Temperature - VOW136

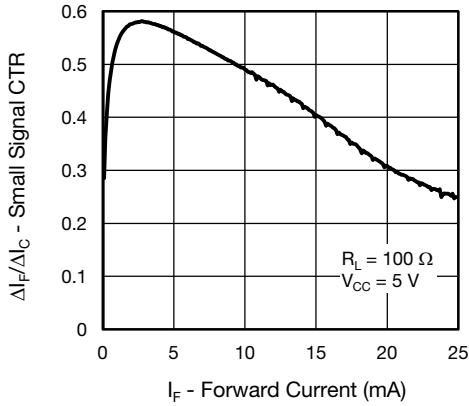

Fig. 10 - Small Signal Current Transfer Ratio vs. Forward Current

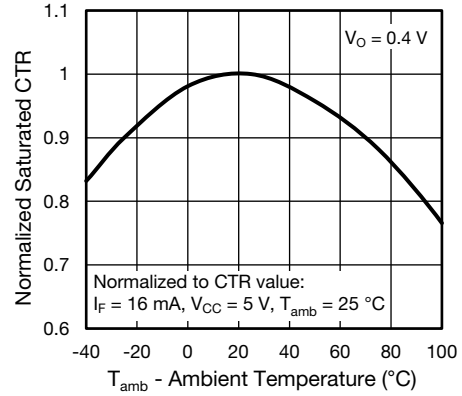

Fig. 13 - Normalized Saturated CTR vs. Ambient Temperature

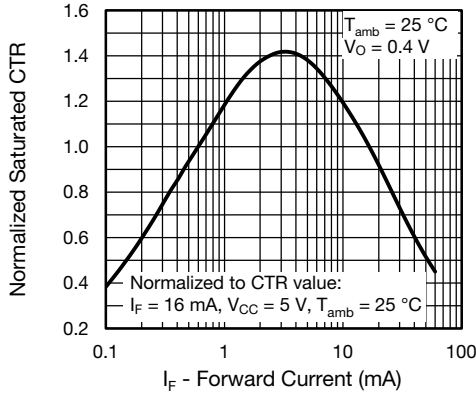

Fig. 11 - Normalized Saturated CTR vs. Forward Current

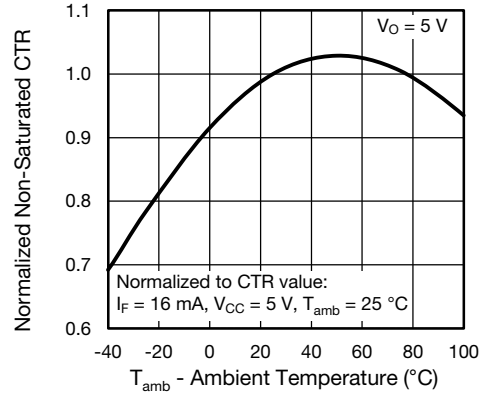

Fig. 14 - Normalized Non-Saturated CTR vs. Ambient Temperature

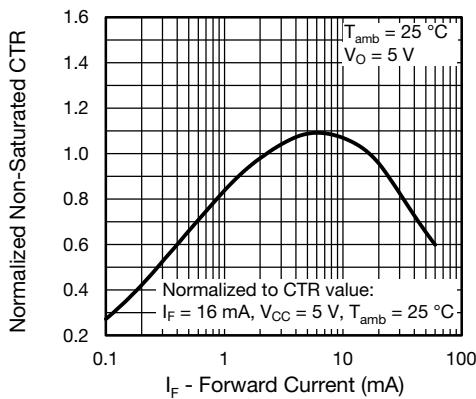
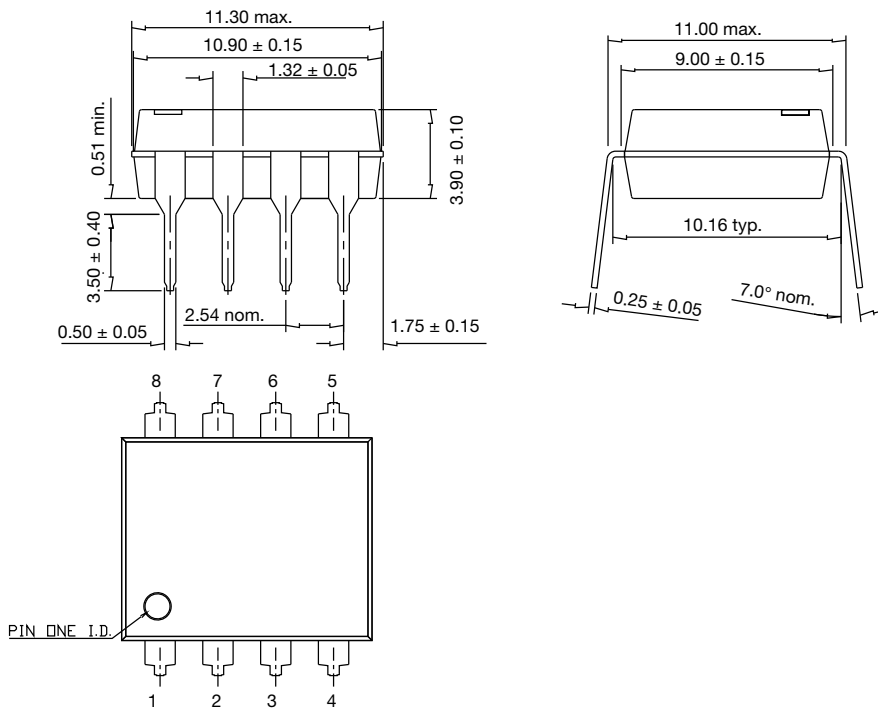

Fig. 12 - Normalized Non-Saturated CTR vs. Forward Current



### PACKAGE DIMENSIONS in millimeters

#### DIP-8, widebody



#### SMD-8, widebody (option 7)

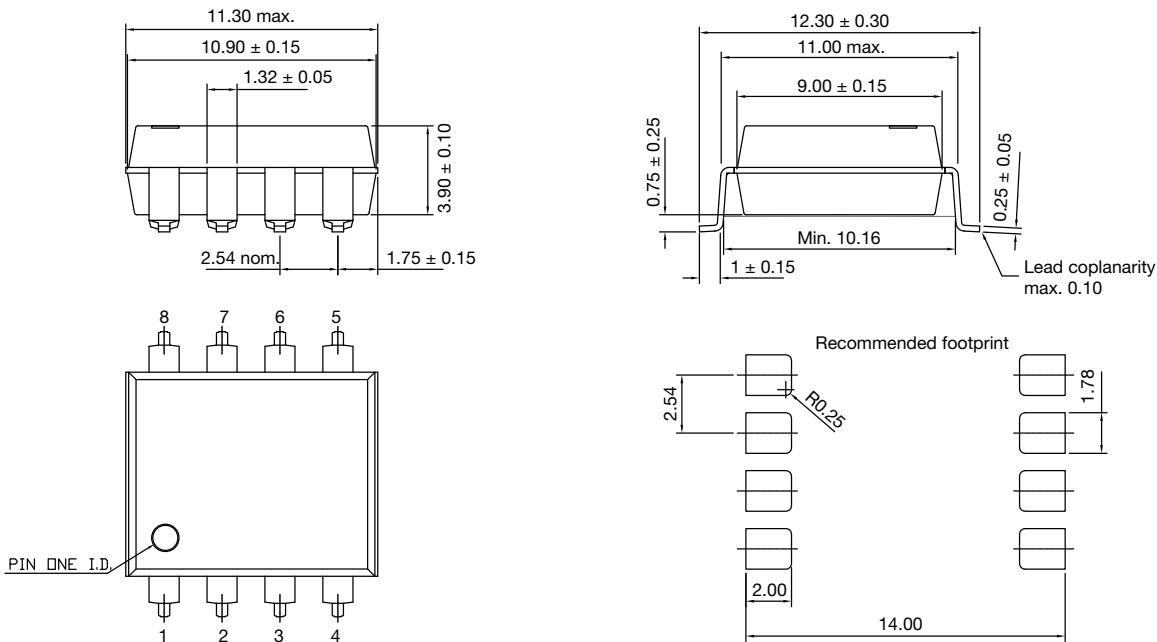

#### PACKAGE MARKING (example of VOW136-X017T)

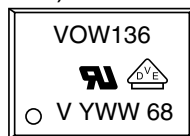

#### Note

- Tape and reel suffix (T) is not part of the package marking.

**PACKING INFORMATION** (tape and reel)

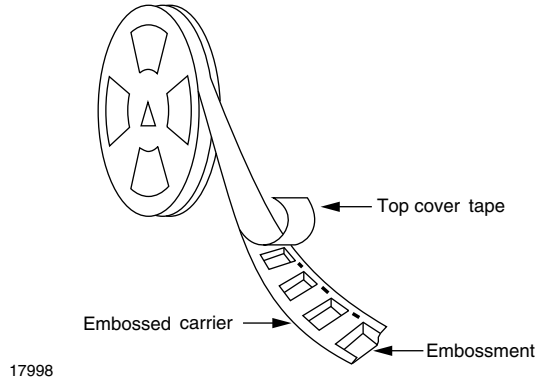

Fig. 15 - Tape and Reel Shipping Medium

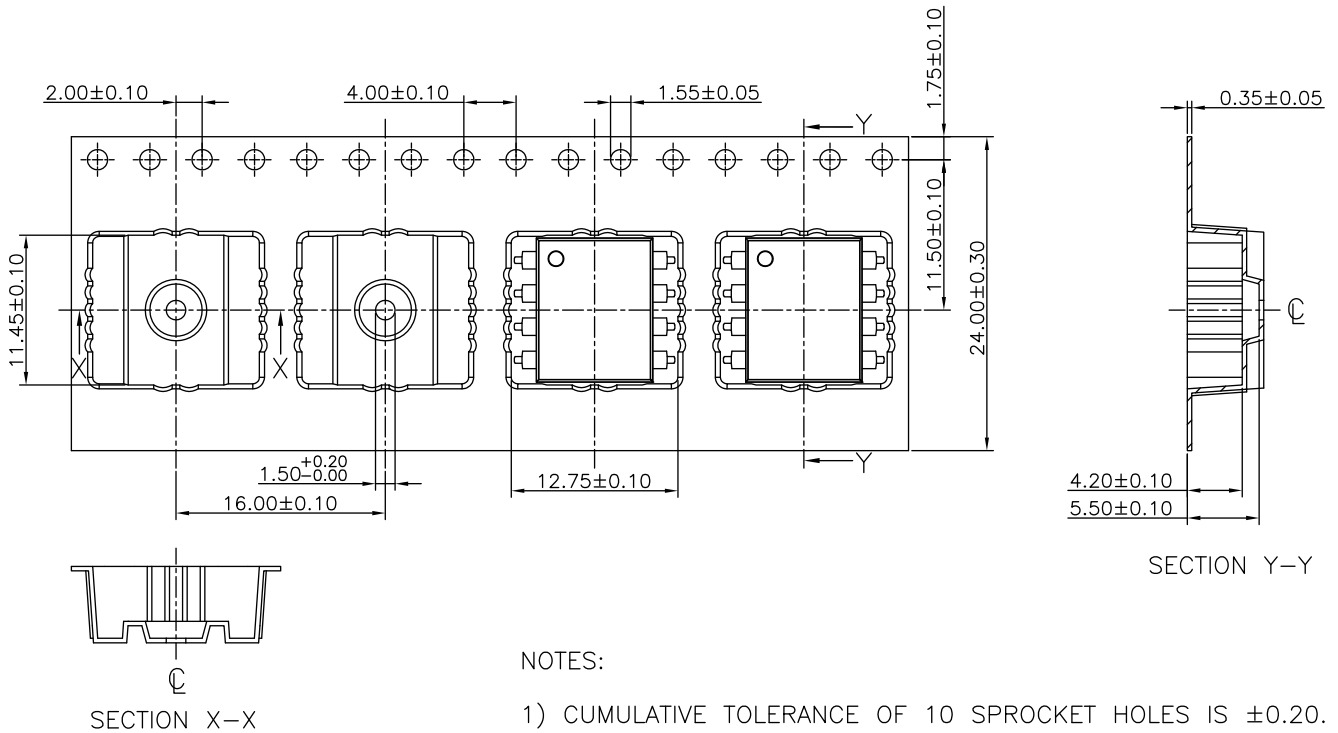
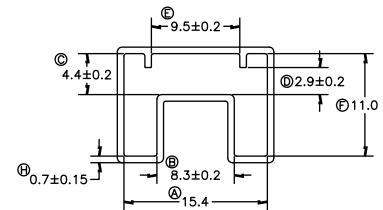
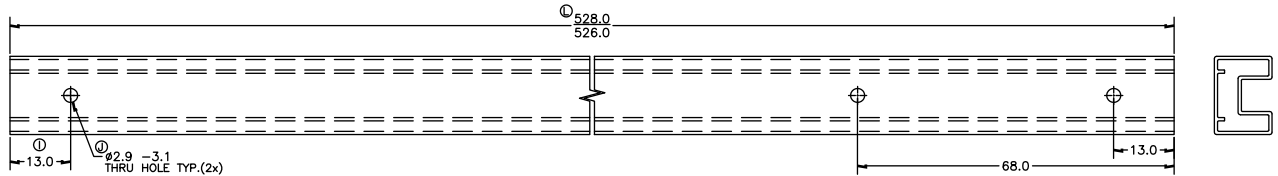

Fig. 16 - Tape and Reel Packing Option 7 (750 parts per reel)



**PACKING INFORMATION** (tubes)

DEVICE PER TUBE			
TYPE	UNITS/TUBE	TUBE/BOX	UNITS/BOX
DIP-8, widebody	40	30	1200



TUBE COLOUR:	CLEAR
PRINT COLOUR:	-

1. ALL DIMENSIONS ARE IN MILLIMETERS, U.O.S.

1. ALL TUBE TOLERANCES TO BE  $\pm 0.25$  UNLESS OTHERWISE SPECIFIED.
2. ALL RADII AND ANGLES REFERENCE ONLY, UNLESS OTHERWISE SPECIFIED.

**SOLDER PROFILES**

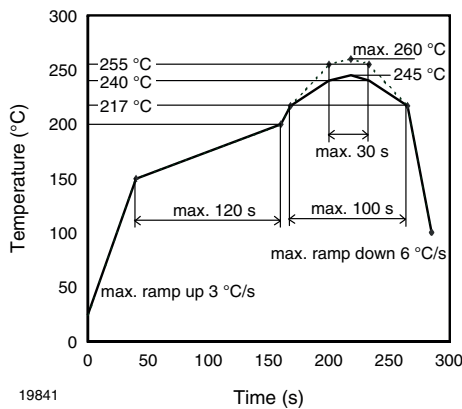

Fig. 17 - Lead (Pb)-free Reflow Solder Profile According to J-STD-020 for SMD Devices

**HANDLING AND STORAGE CONDITIONS**

ESD level: HBM class 2

Floor life: unlimited

Conditions:  $T_{amb} < 30\text{ °C}$ , RH < 85 %

Moisture sensitivity level 1, according to J-STD-020



## Disclaimer

ALL PRODUCT, PRODUCT SPECIFICATIONS AND DATA ARE SUBJECT TO CHANGE WITHOUT NOTICE TO IMPROVE RELIABILITY, FUNCTION OR DESIGN OR OTHERWISE.

Vishay Intertechnology, Inc., its affiliates, agents, and employees, and all persons acting on its or their behalf (collectively, "Vishay"), disclaim any and all liability for any errors, inaccuracies or incompleteness contained in any datasheet or in any other disclosure relating to any product.

Vishay makes no warranty, representation or guarantee regarding the suitability of the products for any particular purpose or the continuing production of any product. To the maximum extent permitted by applicable law, Vishay disclaims (i) any and all liability arising out of the application or use of any product, (ii) any and all liability, including without limitation special, consequential or incidental damages, and (iii) any and all implied warranties, including warranties of fitness for particular purpose, non-infringement and merchantability.

Statements regarding the suitability of products for certain types of applications are based on Vishay's knowledge of typical requirements that are often placed on Vishay products in generic applications. Such statements are not binding statements about the suitability of products for a particular application. It is the customer's responsibility to validate that a particular product with the properties described in the product specification is suitable for use in a particular application. Parameters provided in datasheets and / or specifications may vary in different applications and performance may vary over time. All operating parameters, including typical parameters, must be validated for each customer application by the customer's technical experts. Product specifications do not expand or otherwise modify Vishay's terms and conditions of purchase, including but not limited to the warranty expressed therein.

Except as expressly indicated in writing, Vishay products are not designed for use in medical, life-saving, or life-sustaining applications or for any other application in which the failure of the Vishay product could result in personal injury or death. Customers using or selling Vishay products not expressly indicated for use in such applications do so at their own risk. Please contact authorized Vishay personnel to obtain written terms and conditions regarding products designed for such applications.

No license, express or implied, by estoppel or otherwise, to any intellectual property rights is granted by this document or by any conduct of Vishay. Product names and markings noted herein may be trademarks of their respective owners.

# Mouser Electronics

Authorized Distributor

Click to View Pricing, Inventory, Delivery & Lifecycle Information:

Vishay:

[VOW136-X017T](#) [VOW135-X017T](#) [VOW136-X001](#) [VOW135-X001](#)