

8 A Standard Recovery Surface Mount Rectifiers

FS8G - FS8M

Description

The FS8G to FS8M series offers breakthrough size and performance. It sinks 8 A DC forward current and provides up to 230 A surge current capability with only 0.37 μ A reverse leakage current. All this capability is packed into a small, flat-lead, TO-277 package, optimized for space-constrained applications.

Features

- Very High forward Surge Capability: $I_{FSM} = 230$ A
- Low Leakage Current: 0.37 μ A at $T_A = 25^\circ\text{C}$
- Very Low Profile: Typical Height of 1.1 mm
- Glass Passivated Junction
- HBM (JEDEC A114) > 8 KV; CDM (JEDEC C101C) > 2 KV
- Green Molding Compound as per IEC61249 Standard
- With DAP Option Only
- These Devices are Pb-Free, Halogen Free and are RoHS Compliant

Applications

- General-Purpose Applications
- Reverse Polarity Protection
- Rectifications



ON Semiconductor®

www.onsemi.com

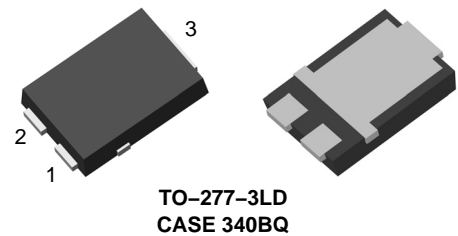
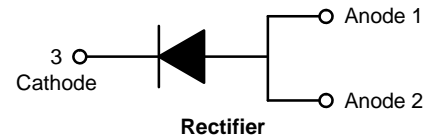

MARKING DIAGRAM

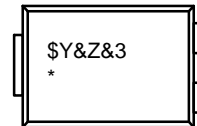

\$Y = ON Semiconductor Logo
&Z = Assembly Plant Code
&3 = Date Code (Year & Week)
* = Specific Device Code
FS8G, FS8J, FS8K, FS8M

ORDERING INFORMATION

See detailed ordering and shipping information on page 3 of this data sheet.

FS8G – FS8M

ABSOLUTE MAXIMUM RATINGS ($T_A = 25^\circ\text{C}$ unless otherwise noted)

Symbol	Rating	Value				Unit
		FS8G	FS8J	FS8K	FS8M	
V_{RRM}	Maximum Repetitive Peak Reverse Voltage	400	600	800	1000	V
V_{RMS}	Maximum RMS Reverse Voltage	280	420	560	700	V
V_{DC}	DC Blocking Voltage	400	600	800	1000	V
$I_{F(AV)}$	Maximum Average Rectified Forward Current	8				A
I_{FSM}	Peak Forward Surge Current: 8.3 ms Single Half Sine-Wave Superimposed on Rated Load	230				A
T_J	Operating Junction Temperature Range	-55 to +150				$^\circ\text{C}$
T_{STG}	Storage Temperature Range	-55 to +150				$^\circ\text{C}$

Stresses exceeding those listed in the Maximum Ratings table may damage the device. If any of these limits are exceeded, device functionality should not be assumed, damage may occur and reliability may be affected.

THERMAL CHARACTERISTICS ($T_A = 25^\circ\text{C}$ unless otherwise noted) (Note 1)

Symbol	Characteristic	Minimum Land Pattern	Maximum Land Pattern	Unit
$R_{\theta JA}$	Junction-to-Ambient Thermal Resistance	100	40	$^\circ\text{C}/\text{W}$
Ψ_{JL}	Junction-to-Lead Thermal Characteristics, Thermocouple Soldered to Anode	20	12	$^\circ\text{C}/\text{W}$
	Junction-to-Lead Thermal Characteristics, Thermocouple Soldered to Cathode	6	5	

- The thermal resistances ($R_{\theta JA}$ & Ψ_{JL}) are characterized with device mounted on the following FR4 printed circuit boards, as shown in Figure 1 and Figure 2. PCB size: 76.2 x 114.3 mm. Minimum land pattern size: 4.9 x 4.8 mm (big pattern, x1), 1.4 x 1.52 mm (small pattern, x2). Maximum land pattern size: 30 x 30 mm (pattern, x2). Force line trace size = 55 mils, sense line trace size = 4 mils.



Figure 1. Minimum Land Pattern of 2 oz Copper

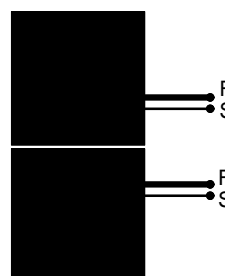

Figure 2. Maximum Land Pattern of 2 oz Copper

ELECTRICAL CHARACTERISTICS ($T_A = 25^\circ\text{C}$ unless otherwise noted)

Symbol	Parameter	Conditions	Min	Typ	Max	Unit
V_F	Forward Voltage	$I_F = 8\text{ A}$	-	0.951	1.1	V
		$I_F = 8\text{ A}, T_A = 125^\circ\text{C}$		0.845		
I_R	DC Reverse Current	$V_R = V_{DC}$	-	0.37	5	μA
		$V_R = V_{DC}, T_A = 125^\circ\text{C}$		84		
T_{rr}	Reverse Recovery Time	$I_F = 0.5\text{ A}, I_R = 1\text{ A}, I_{rr} = 0.25\text{ A}$		3.37		μs
C_J	Junction Capacitance	$V_R = 0\text{ V}, f = 1\text{ MHz}$		118		pF

Product parametric performance is indicated in the Electrical Characteristics for the listed test conditions, unless otherwise noted. Product performance may not be indicated by the Electrical Characteristics if operated under different conditions.

FS8G – FS8M

ORDERING INFORMATION

Part Number	Top Mark	Package	Shipping†
FS8G	FS8G	TO-277 3L (No DAP Option) (Pb-Free/Halogen Free)	5000 / Tape & Reel
FS8J	FS8J	TO-277 3L (No DAP Option) (Pb-Free/Halogen Free)	5000 / Tape & Reel
FS8K	FS8K	TO-277 3L (No DAP Option) (Pb-Free/Halogen Free)	5000 / Tape & Reel
FS8M	FS8M	TO-277 3L (No DAP Option) (Pb-Free/Halogen Free)	5000 / Tape & Reel

†For information on tape and reel specifications, including part orientation and tape sizes, please refer to our Tape and Reel Packaging Specifications Brochure, BRD8011/D.

FS8G – FS8M

TYPICAL PERFORMANCE CHARACTERISTICS

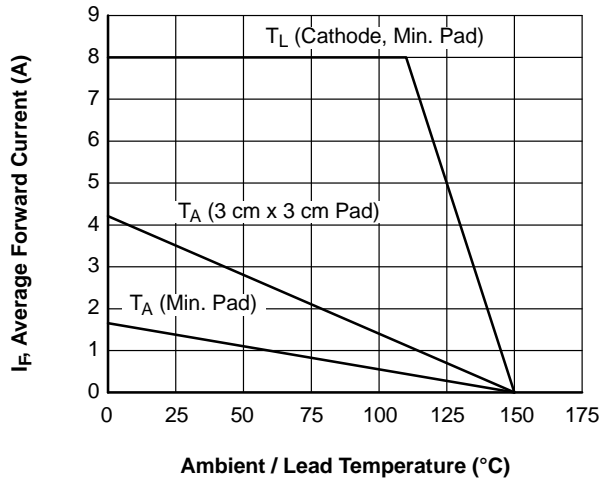

Figure 3. Forward Current Derating Curve

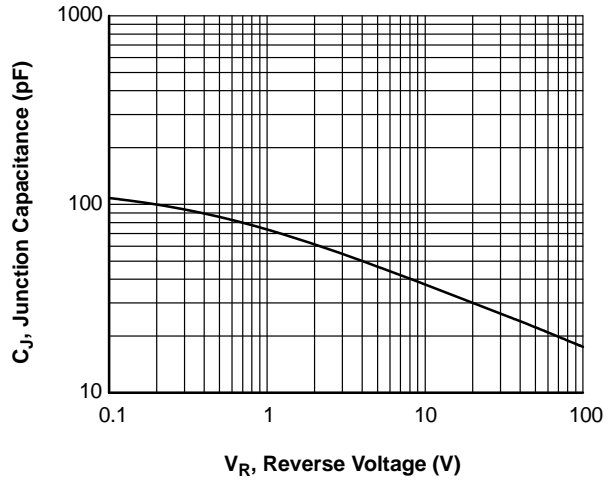

Figure 4. Typical Junction Capacitance

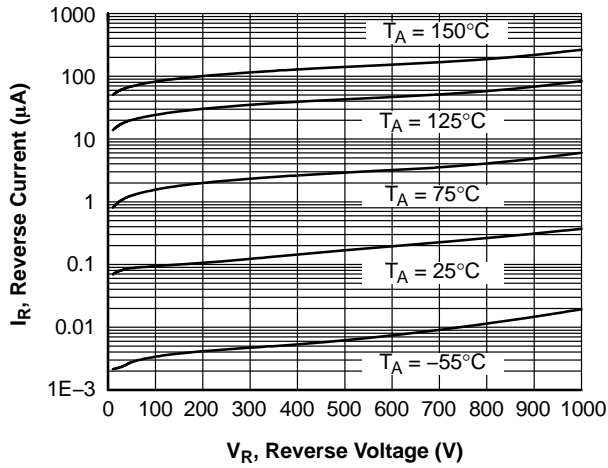

Figure 5. Typical Reverse Characteristics

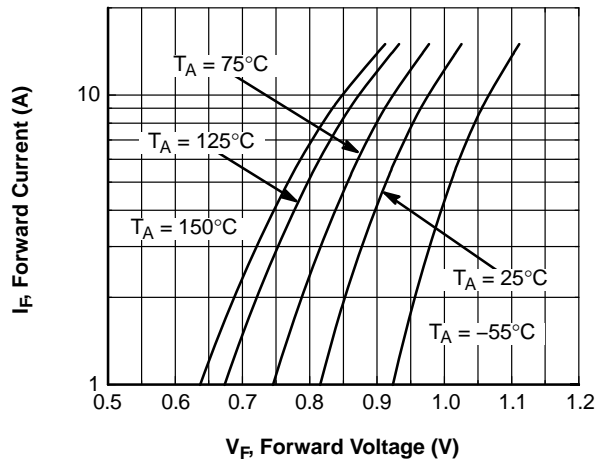

Figure 6. Typical Forward Characteristics

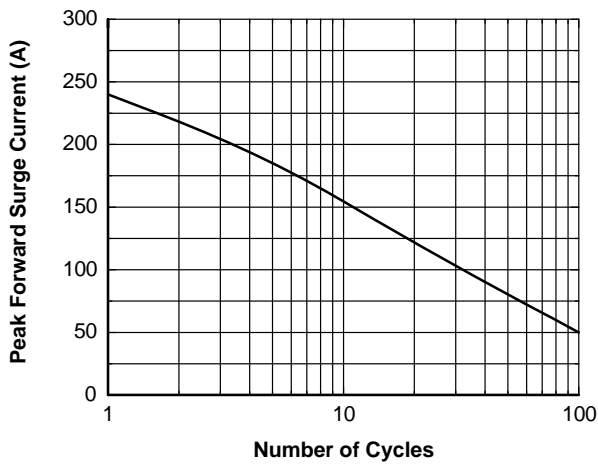
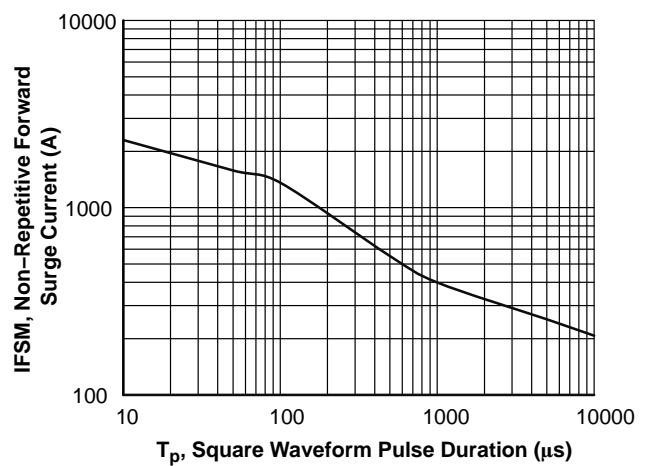

Figure 7. Maximum Non-Repetitive Peak Forward Surge Current



NOTE: Typical performance bases on a limited sample size, not guarantee rating.

Figure 8. Typical Non-Repetitive Forward Surge Current

MECHANICAL CASE OUTLINE

PACKAGE DIMENSIONS

ON Semiconductor®



TO-277-3LD
CASE 340BQ
ISSUE O

DATE 30 SEP 2016

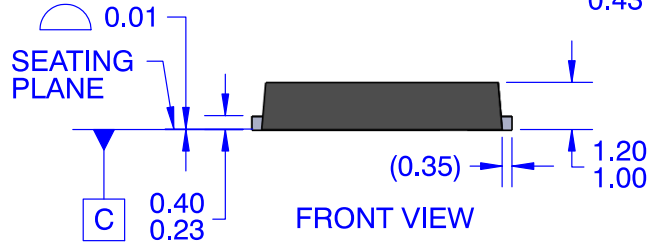
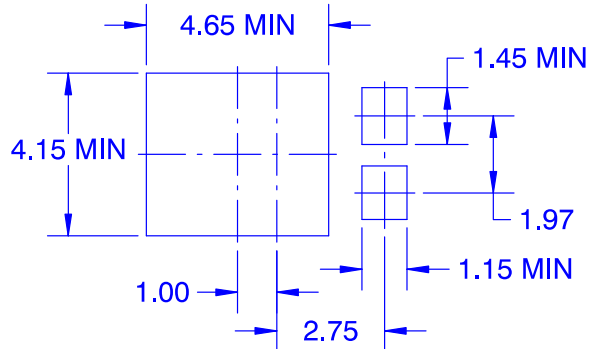

NOTES: UNLESS OTHERWISE SPECIFIED
 A. PACKAGE REFERENCE: JEDEC TO-277
 B. DIMENSIONS ARE EXCLUSIVE OF BURRS, MOLD FLASH, AND TIE BAR EXTRUSIONS.
 C. ALL DIMENSIONS ARE IN MILLIMETERS.
 D. DOES NOT COMPLY TO JEDEC STANDARD VALUE.

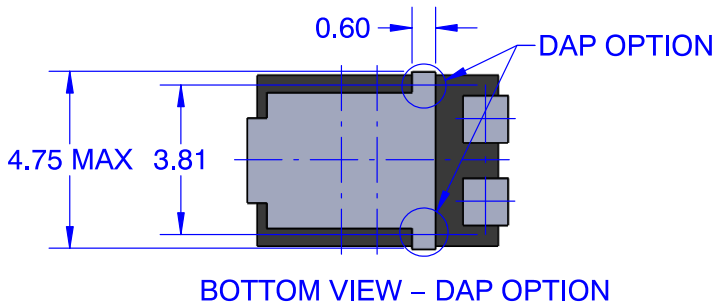
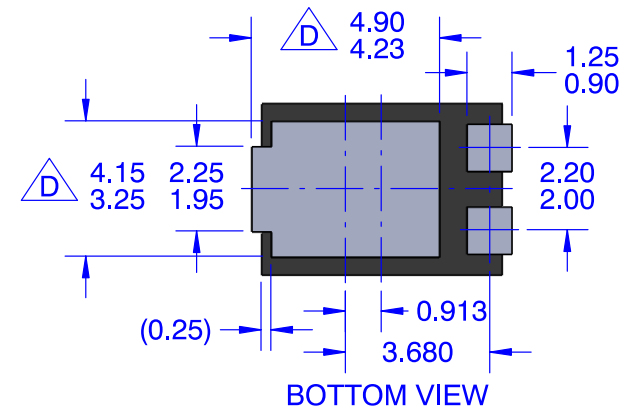

DOCUMENT NUMBER:	98AON13861G	Electronic versions are uncontrolled except when accessed directly from the Document Repository. Printed versions are uncontrolled except when stamped "CONTROLLED COPY" in red.
DESCRIPTION:	TO-277-3LD	PAGE 1 OF 1

ON Semiconductor and are trademarks of Semiconductor Components Industries, LLC dba ON Semiconductor or its subsidiaries in the United States and/or other countries. ON Semiconductor reserves the right to make changes without further notice to any products herein. ON Semiconductor makes no warranty, representation or guarantee regarding the suitability of its products for any particular purpose, nor does ON Semiconductor assume any liability arising out of the application or use of any product or circuit, and specifically disclaims any and all liability, including without limitation special, consequential or incidental damages. ON Semiconductor does not convey any license under its patent rights nor the rights of others.

onsemi, **Onsemi**, and other names, marks, and brands are registered and/or common law trademarks of Semiconductor Components Industries, LLC dba "**onsemi**" or its affiliates and/or subsidiaries in the United States and/or other countries. **onsemi** owns the rights to a number of patents, trademarks, copyrights, trade secrets, and other intellectual property. A listing of **onsemi**'s product/patent coverage may be accessed at www.onsemi.com/site/pdf/Patent-Marking.pdf. **onsemi** reserves the right to make changes at any time to any products or information herein, without notice. The information herein is provided "as-is" and **onsemi** makes no warranty, representation or guarantee regarding the accuracy of the information, product features, availability, functionality, or suitability of its products for any particular purpose, nor does **onsemi** assume any liability arising out of the application or use of any product or circuit, and specifically disclaims any and all liability, including without limitation special, consequential or incidental damages. Buyer is responsible for its products and applications using **onsemi** products, including compliance with all laws, regulations and safety requirements or standards, regardless of any support or applications information provided by **onsemi**. "Typical" parameters which may be provided in **onsemi** data sheets and/or specifications can and do vary in different applications and actual performance may vary over time. All operating parameters, including "Typicals" must be validated for each customer application by customer's technical experts. **onsemi** does not convey any license under any of its intellectual property rights nor the rights of others. **onsemi** products are not designed, intended, or authorized for use as a critical component in life support systems or any FDA Class 3 medical devices or medical devices with a same or similar classification in a foreign jurisdiction or any devices intended for implantation in the human body. Should Buyer purchase or use **onsemi** products for any such unintended or unauthorized application, Buyer shall indemnify and hold **onsemi** and its officers, employees, subsidiaries, affiliates, and distributors harmless against all claims, costs, damages, and expenses, and reasonable attorney fees arising out of, directly or indirectly, any claim of personal injury or death associated with such unintended or unauthorized use, even if such claim alleges that **onsemi** was negligent regarding the design or manufacture of the part. **onsemi** is an Equal Opportunity/Affirmative Action Employer. This literature is subject to all applicable copyright laws and is not for resale in any manner.

PUBLICATION ORDERING INFORMATION

LITERATURE FULFILLMENT:

Email Requests to: orderlit@onsemi.com

onsemi Website: www.onsemi.com

TECHNICAL SUPPORT

North American Technical Support:

Voice Mail: 1 800-282-9855 Toll Free USA/Canada

Phone: 011 421 33 790 2910

Europe, Middle East and Africa Technical Support:

Phone: 00421 33 790 2910

For additional information, please contact your local Sales Representative

Mouser Electronics

Authorized Distributor

Click to View Pricing, Inventory, Delivery & Lifecycle Information:

[onsemi:](#)

[FS8K](#) [FS8M](#) [FS8G](#) [FS8J](#)