

**TIMEGUARD®**

6.5W LED Energy Saver  
PIR Bulkhead Light

Model: LED88PIRN – Black



Installation & Operating Instructions

# 1. General Information

These instructions should be read carefully and retained for further reference and maintenance.

## 2. Safety

- Before installation or maintenance, ensure the mains supply to the luminaire is switched off and the circuit supply fuses are removed or the circuit breaker turned off.
- It is recommended that a qualified electrician is consulted or used for the installation of this luminaire and install in accordance with the current IEE wiring and Building Regulations.
- Check that the total load on the circuit including when this luminaire is fitted does not exceed the rating of the circuit cable, fuse or circuit breaker.

## 3. Technical Specifications

- 230V AC 50 Hz
- This luminaire is of class II construction and must not be earthed
- 6.5W LED Non replaceable lamp
- Energy efficiency: Class A+
- Energy Usage: 6.5Kwh/1000H
- Lumen Output: 500lm
- Colour Temperature: 3700K – 4200K
- Beam Angle: 90° x 90°
- IP55 Rated suitable for restricted external applications
- Operating Temperature: -20°C to +40°C
- Detection Angle: 140° degrees
- Detection Range: 10 meters
- Time On Adjustment: 5 Seconds to 10 Minutes
- Dusk Level Adjustment: Day and Night, or Night time only.
- Dusk to Dawn (D) Mode: Luminaire remains ON from Dusk until Dawn
- CE Compliant
- Dimensions: H 205mm, W 108mm, D 78.5mm

## 4. Selecting a Location

- The motion detector has a number of detection zones, at various vertical and horizontal angles as shown (see Image A)
- A moving human body needs to cross/enter one of these zones to activate the sensor. The best all-round coverage is achieved with the unit mounted at the optimum height of 1.8m.
- Careful positioning of the sensor will be required for optimum performance (See Image A).

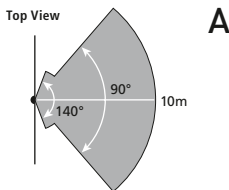

**Detection Angle and Range:**  
Min 10m range at 90° angle  
Min 3m range at 140° angle

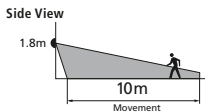

- The sensor is more sensitive to movement **ACROSS** its field of vision than to movement directly **TOWARD** (See Image B). Therefore position the unit so that the sensor looks **ACROSS** the likely approach path.
- Avoid positioning the sensor where there are any sources of heat in the detection area (extractor fans, tumble dryers etc.).
- Reflective surfaces (i.e. pools of water or white-painted walls) and overhanging branches may cause false activation under extreme conditions.
- During extreme weather conditions the motion sensor may exhibit unusual behaviour, but this does not indicate a fault with the sensor. Once normal weather conditions return, the sensor will resume normal operation.

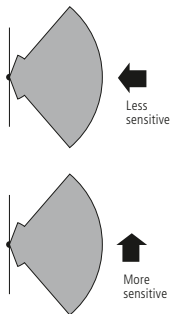

## 5. Installation

- 5.1 Ensure the mains supply is switched off and the circuit supply fuses are removed or the circuit breaker turned OFF.
- 5.2 Remove the wall plate by releasing the 2 lugs, left & right, located on the rear bottom section of the luminaire and gently ease the wall plate down/outwards from the top.

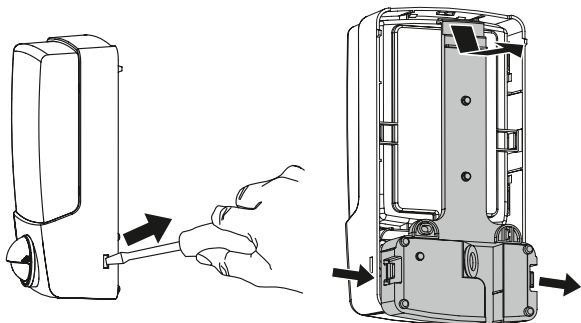

- 5.3 Mark the position of the mounting holes on the wall using the wall plate as a template and drill the holes ensuring not to infringe with any gas/water pipes or electrical cables that may be hidden below the surface.  
Insert the wall plugs.
- 5.4 Secure the supply cable into the wall plate through the hole(s) provided ensuring that a cable gland, grommet or sealing compound is used to maintain the IP rating of the luminaire.

5.5 Fix the wall plate using the correct screws for the wall plugs installed.

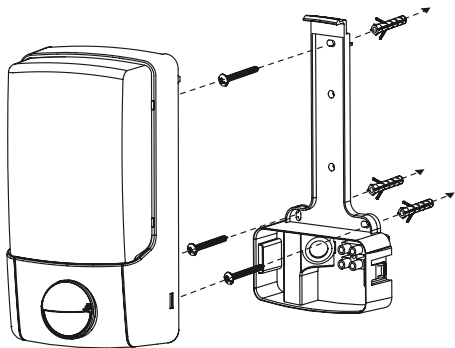

5.6 Terminate the cable into the terminal block (See section 6. Connection Diagram) ensuring correct polarity is observed and that all bare conductors are sleeved.

5.7 Re-connect the luminaire to the wall plate by positioning it on the top first, and then push on the bottom of the unit ensuring both lugs click into place.

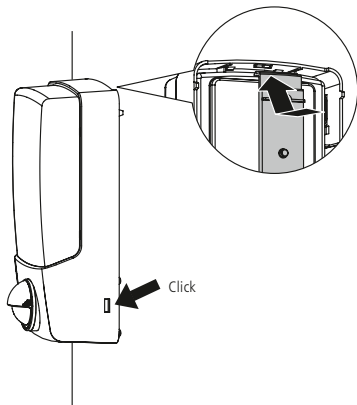

## 6. Connection Diagram

- Connect the 230V 50Hz mains supply cable to the terminal block as shown.

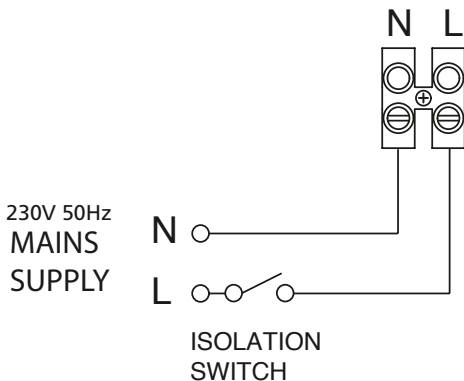
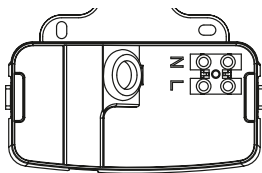

Supply Live (Brown or Red) to L  
Supply Neutral (Blue or Black) to N

## 7. Operating and Testing

### Test Mode

- Rotate the sensor cover to reveal the adjustment knobs (See Image C).

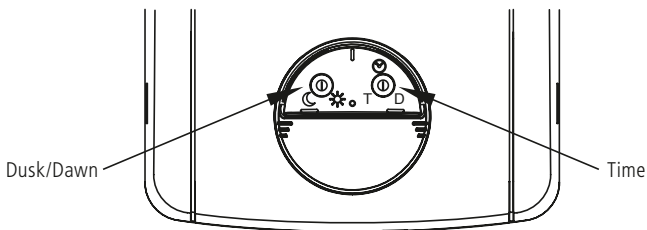
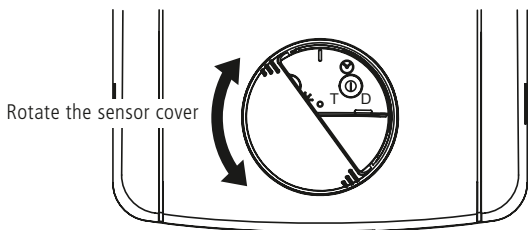

- The unit can be set up in daylight or at night. The adjustment knobs are factory set, Lux is set to the 'moon' setting and the Time is set to a minimum which is fully anti-clockwise (See Image D).

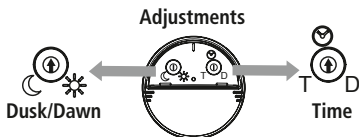

D

**Environment lux level to turn On**

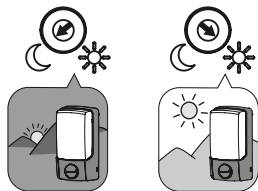

**Turn On time adjustment**

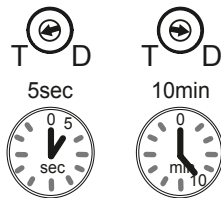

7

- Turn the power ON, the lamp will illuminate for approximately 30 seconds. This indicates the unit is wired correctly.
- After approximately 30 second the light will turn off, the unit is now in Test Mode.

## Walk Test Procedure

- The lamp will now illuminate for approximately 5 seconds every time movement is detected.
- Walk across the detection area approximately 5 meters from the unit, each time you are detected the lamp will illuminate.
- Now stand still until the lamp extinguishes (this should take approx. 5 seconds)
- Start moving again, when you are detected again the lamp will illuminate .
- Repeat the above, walking in various angles and distances to the unit. This will help you establish the detection pattern.



## Setting Up for Automatic Operation

The TIME setting controls how long the unit remains illuminated following activation and after all motion ceases. (See Image D, the Time adjustment knob is indicated by the 'Clock' symbol).

- The minimum time (anti-clockwise) is approx. 5 seconds, whilst the maximum time (clockwise) is approx. 10 minutes.
- Set the control to the desired setting between these limits.

The DUSK control determines the level of darkness required for the unit to start operating. The setting is best achieved by following the procedure below (See Image D, the Dusk adjustment knob is indicated by the "Moon" and "Sun" symbols).

- Set the DUSK control knob fully anti-clockwise and wait until darkness falls.
- When the ambient light level reaches the level of darkness at which you wish the lamp to become operative (i.e. at dusk) SLOWLY rotate the control in a clockwise direction until a point is reached where the lamp illuminates, leave the controls set at this point.
- At this position the unit should become operative at approximately the same level of darkness each evening.
- Observe the operation of the unit, if the unit is starting to operate too early (i.e. when it is quite bright) adjust the control slightly anti-clockwise. If the unit starts to operate too late (i.e. when it is very dark) adjust the control slightly clockwise.
- Continue to adjust until the unit operated as desired.

## Dusk to Dawn (D) Mode

- When setting the Time knob to "D", which is fully clockwise (See Image E), the motion detector of the Bulkhead won't function.
- The lamp will operate depending on the LUX level, i.e. Dusk to Dawn.

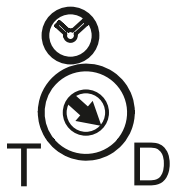

=

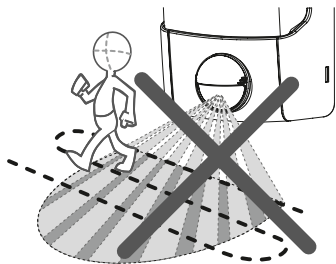

## 8.Support

**Note:** If you have any concerns that the intended application of this product does not meet your requirements, please contact Timeguard directly prior to installation.

## 9.Guarantee & Company Details

### 3 Year Guarantee

In the unlikely event of this product becoming faulty due to defective material or manufacture, within 3 years of the date of purchase, please return it to your supplier in the first year with proof of purchase and it will be replaced free of charge. For years 2 to 3 or any difficulty in the first year, telephone our helpline.

Note: a proof of purchase is required in all cases. For all eligible replacements (where agreed by Timeguard) the customer is responsible for all shipping/postage charges outside of the UK. All shipping costs are to be paid in advance before a replacement is sent.



If you experience problems, do not immediately return the unit to the store. Telephone the Timeguard Customer Helpline;

HELPLINE

**020 8450 0515**

or email [helpline@timeguard.com](mailto:helpline@timeguard.com)

Qualified Customer Support Co-ordinators will be on-line to assist in resolving your query.



A **theben** Group Company

For a product brochure please contact:

**Timeguard Limited.**

Victory Park, 400 Edgware Road,  
London NW2 6ND

Sales Office: 020 8452 1112  
or email [csc@timeguard.com](mailto:csc@timeguard.com)

**[www.timeguard.com](http://www.timeguard.com)**