

Automotive Grade LTE + Wi-Fi + GNSS External Combo Antenna



AECS1806C03Z

Request Samples



Check Inventory



181.7 x 68.9 x 69.1 mm
RoHS/RoHS II Compliant
MSL Level = 1

Features

- 3 Cabled Combo Antenna
 - 1x 4G/LTE Antenna
 - 1x 2.4/5GHz Wi-Fi Antenna
 - 1x Active GNSS/GPS/GLONASS/BeiDou/QZSS
- Manufactured in Automotive Certified lines
 - IATF 16949 certified
- PPAP available upon request
- IP67 rated
- Easy installation using Screw
- Fully customizable cable and connection options for RF connection

Applications

- IoT
- M2M
- Smart City
- Gateways and routers
- Telematics
- Transportation
- Smart Agriculture
- Geolocation and Tracking

Product Image



Automotive Grade LTE + Wi-Fi + GNSS External Combo Antenna



AECS1806C03Z

Request Samples



Check Inventory



181.7 x 68.9 x 69.1 mm
RoHS/RoHS II Compliant
MSL Level = 1

Part Number Builder

AECS1806C03Z -

Color / UV Coating	
Code	Description
S (Standard)	Black without UV coating
A	Black with UV Coating
B	White without UV Coating
C	White with UV Coating

Cable length in 'mm'	
Code	Description
3000 (Standard)	3000 mm
Other Examples :	
0200	200 mm
2000	2000 mm

Cable Type & Connector Type				
Code	Cable Type	Connector Type		
		LTE	GNSS	Wi-Fi
S (Standard)	RG-174	SMA (M)	SMA (M)	-
	LMR-100	-	-	SMA (M)
A	LMR-100	SMA (M)	SMA (M)	SMA (M)
B		SMA (M)	FAKRA C (F)	SMA (M)
C		FAKRA D (F)	SMA (M)	SMA (M)
D		FAKRA D (F)	FAKRA C (F)	SMA (M)
E	RG-174	SMA (M)	FAKRA C (F)	-
	LMR-100	-	-	SMA (M)
F	RG-174	FAKRA D (F)	SMA (M)	-
	LMR-100	-	-	SMA (M)
G	RG-174	FAKRA D (F)	FAKRA C (F)	-
	LMR-100	-	-	SMA (M)

Example Configurations :

Part Number	UV Protection Coating / Color	Cable length	Cable Type / Connector Type
AECS1806C03Z S-3000S	Yes / Black	3000 mm	2xRG-174 with 1xSMA (M) for LTE + 1xSMA (M) for GNSS + 1xLMR-100 with 1xSMA (M) for Wi-Fi (Standard)
AECS1806C03Z A-1000A	Yes / Black	1000 mm	3xLMR-100 with 1xSMA (M) for LTE + 1xSMA (M) for Wi-Fi and 1xSMA (M) for GNSS
AECS1806C03Z B-5000G	No / White	5000 mm	2xRG-174 with 1xFAKRA D (F) for LTE + 1xFAKRA C (F) for GNSS + 1xLMR-100 with 1xSMA (M) for Wi-Fi

Note :

- For the standard part number (AECS1806C03Z **S-3000S**), please refer to the packaging at the end of the document.
- For additional configuration (AECS1806C03Z -), MOQs, pricing and packaging changes may be applicable.

Automotive Grade LTE + Wi-Fi + GNSS External Combo Antenna



AECS1806C03Z

Request Samples



Check Inventory



181.7 x 68.9 x 69.1 mm
RoHS/RoHS II Compliant
MSL Level = 1

Electrical Specification

Parameter	Specification			Unit
	Min	Typ	Max	
GNSS Antenna				
Frequency	1561		1602	MHz
Gain (Zenith)			2.0	dBic
VSWR			1.5	
Impedance		50		Ω
Polarization	RHCP			
LNA				
Noise Figure			2.0	dB
Gain	26	28	30	dB
VSWR			2.0	
Supply Voltage	3.0		5.0	V
Current Consumption			15.0	mA
LTE Antenna				
Frequency	698		960	MHz
	1710		2690	
VSWR			3.0	
Gain (Zenith)			3.5	dB
Impedance		50		Ω
Polarization	Linear			
Wi-Fi Antenna				
Frequency	2400		2483.5	MHz
	4900		5825	
VSWR			2.0	
Gain (Zenith)			2.0	dB
Impedance		50		Ω
Polarization	Linear			

Mechanical Specification

Parameter	Specification
Antenna Dimension	181.7 x 68.9 x 69.1 mm
Mounting Type	Screw
RF Connector	3x SMA Male
RF Cable	2x RG174 (LTE,GNSS) + 1xLMR-100 (Wi-Fi)
Cable Length	3 m



5101 Hidden Creek Ln Spicewood TX 78669
Phone: 512-371-6159 | Fax: 512-351-8858
For terms and conditions of sales, please visit:
www.abracon.com

REVISED: 05-08-20

ABRACON IS
ISO9001-2015
CERTIFIED

Automotive Grade LTE + Wi-Fi + GNSS External Combo Antenna



AECS1806C03Z

Request Samples



Check Inventory



181.7 x 68.9 x 69.1 mm
RoHS/RoHS II Compliant
MSL Level = 1

Environmental Specification

Parameter	Specification
Operating Temperature	-40°C to +85°C
Storage Temperature	-40°C to +85°C
Relative Humidity	Up to 95%
RoHS Compliance	Yes
PB Free	Yes
MSL	1
ESD Sensitive	Yes
Vibration	10 to 1000 Hz G = 28.7 m/s ²
UL rating	UL-94 HB
Ingress Protection	IP67 (excluding cable outlet)

Product Dimension

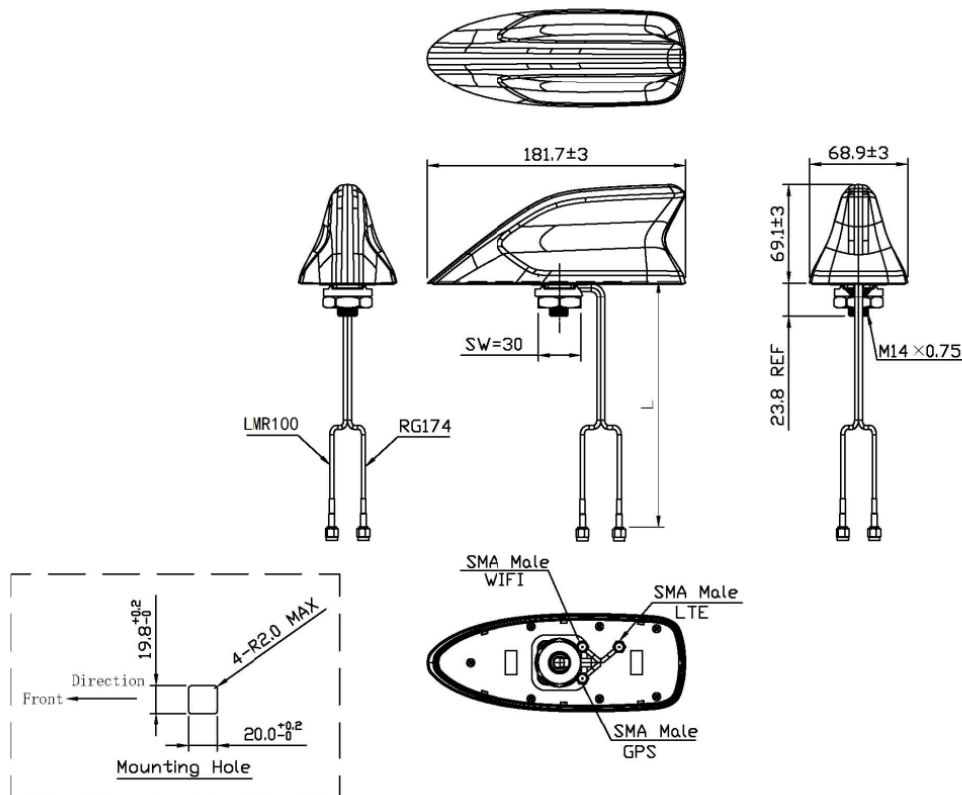

Unit: mm



5101 Hidden Creek Ln Spicewood TX 78669
 Phone: 512-371-6159 | Fax: 512-351-8858
 For terms and conditions of sales, please visit:
www.abracon.com

REVISED: 05-08-20

ABRACON IS
 ISO9001-2015
 CERTIFIED

Automotive Grade LTE + Wi-Fi + GNSS External Combo Antenna



AECS1806C03Z

Request Samples



Check Inventory



181.7 x 68.9 x 69.1 mm
RoHS/RoHS II Compliant
MSL Level = 1

Test Measurements - VSWR

GNSS

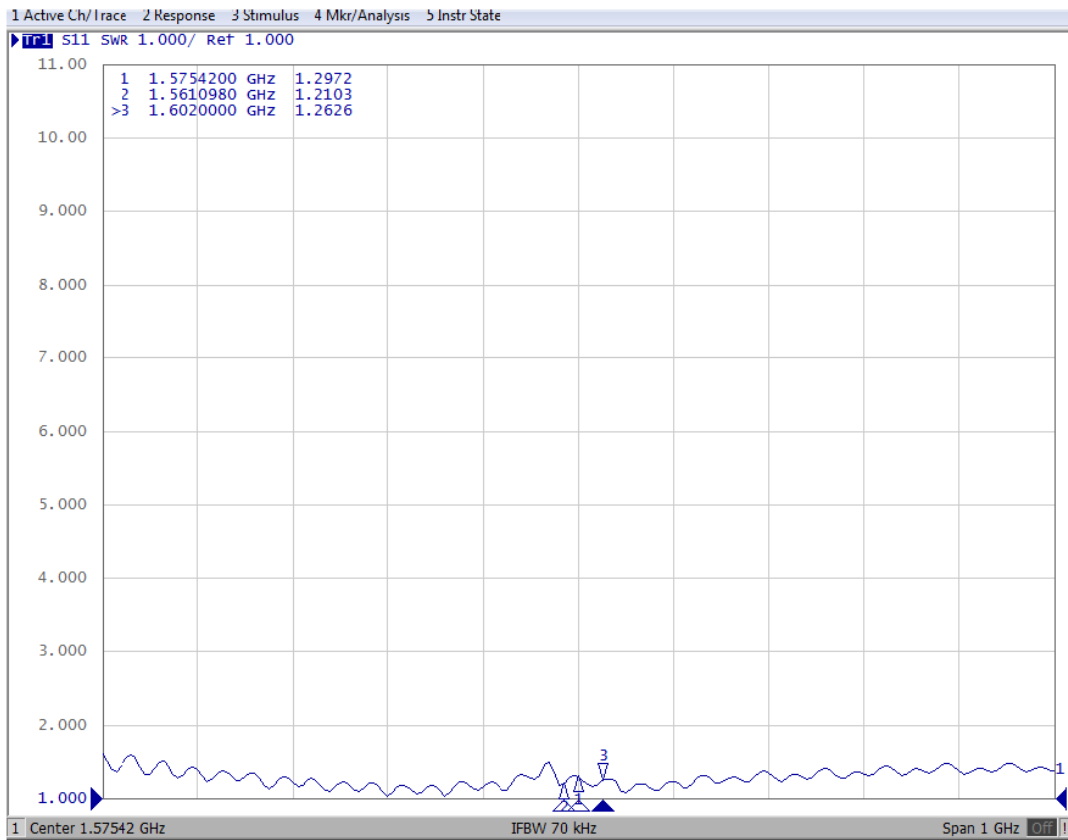

Automotive Grade LTE + Wi-Fi + GNSS External Combo Antenna



AECS1806C03Z

Request Samples



Check Inventory



181.7 x 68.9 x 69.1 mm
RoHS/RoHS II Compliant
MSL Level = 1

LTE

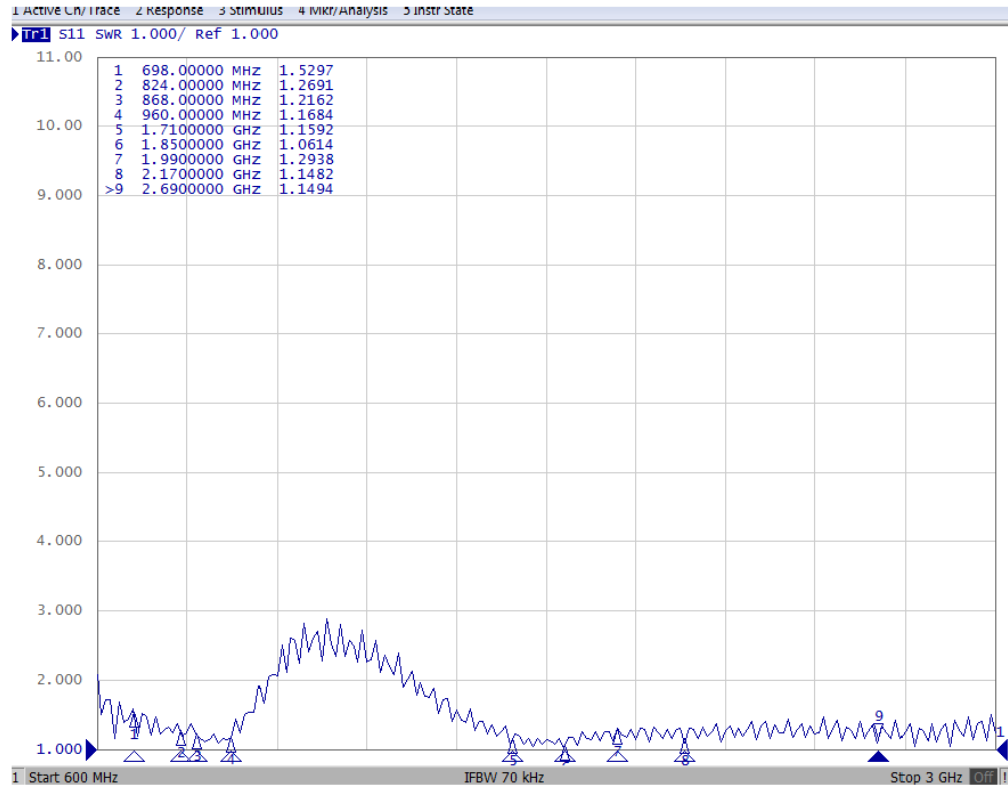

5101 Hidden Creek Ln Spicewood TX 78669
Phone: 512-371-6159 | Fax: 512-351-8858
For terms and conditions of sales, please visit:
www.abracon.com

REVISED: 05-08-20

ABRACON IS
ISO9001-2015
CERTIFIED

Automotive Grade LTE + Wi-Fi + GNSS External Combo Antenna



AECS1806C03Z

Request Samples



Check Inventory



181.7 x 68.9 x 69.1 mm
RoHS/RoHS II Compliant
MSL Level = 1

Wi-Fi

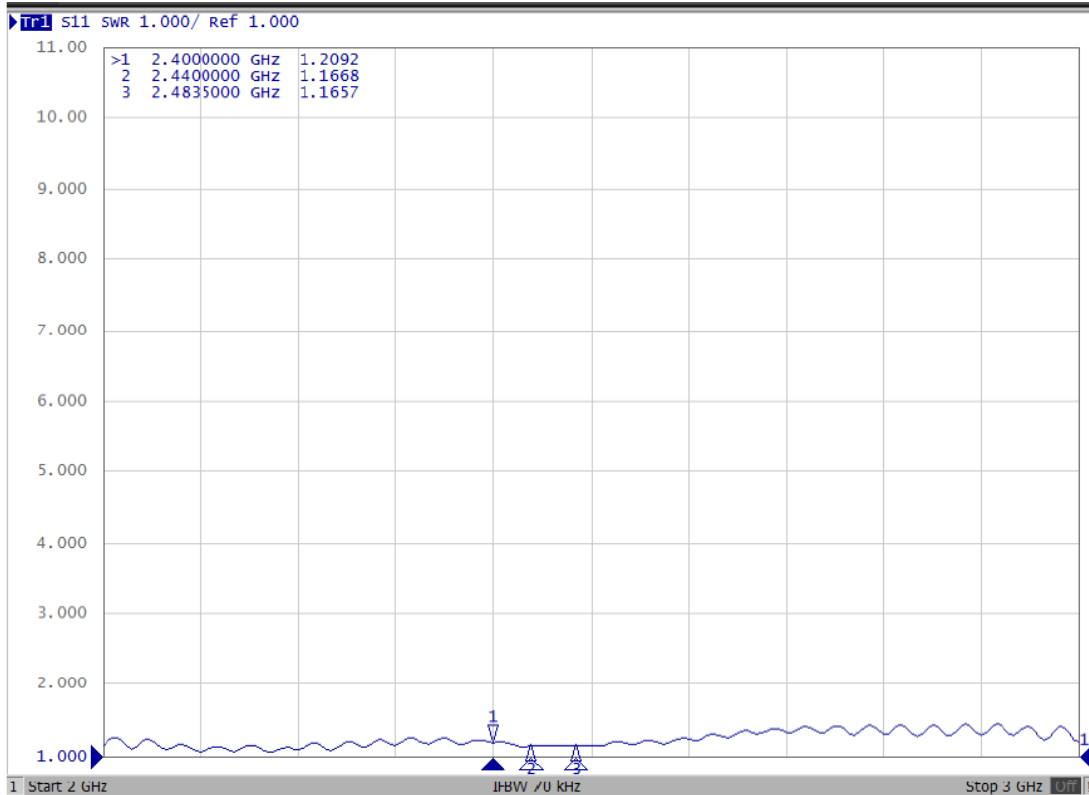

Radiation Characteristics

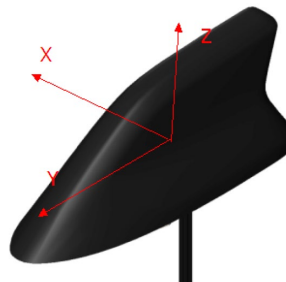

Automotive Grade LTE + Wi-Fi + GNSS External Combo Antenna



AECS1806C03Z

Request Samples



Check Inventory



181.7 x 68.9 x 69.1 mm
RoHS/RoHS II Compliant
MSL Level = 1

2D Pattern

GNSS

XY - Plane

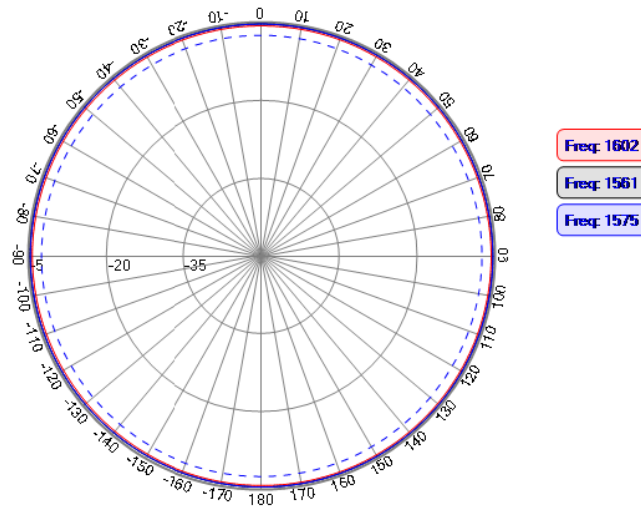

XZ - Plane

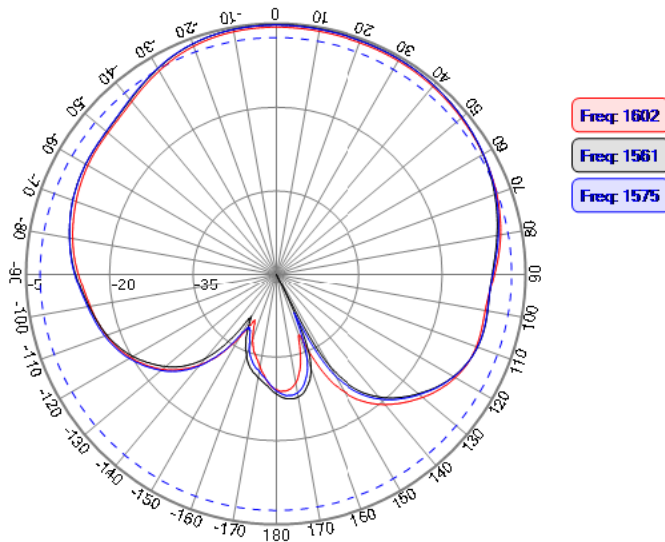

YZ - Plane

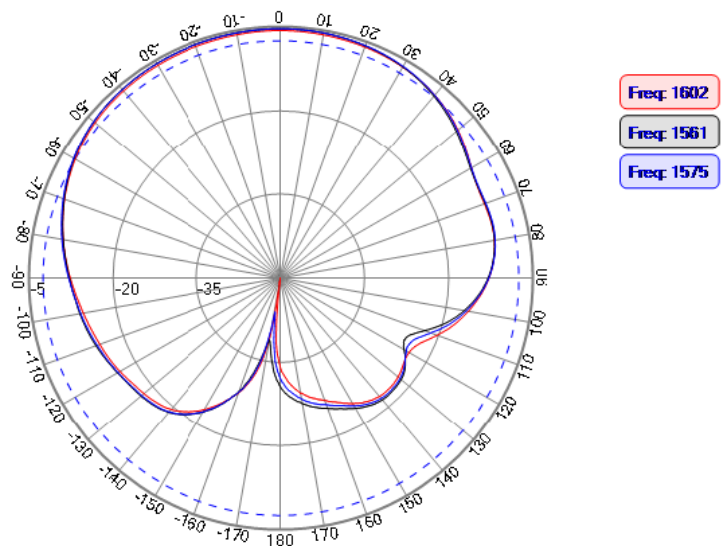

5101 Hidden Creek Ln Spicewood TX 78669
Phone: 512-371-6159 | Fax: 512-351-8858
For terms and conditions of sales, please visit:
www.abracon.com

REVISED: 05-08-20

ABRACON IS
ISO9001-2015
CERTIFIED

Automotive Grade LTE + Wi-Fi + GNSS External Combo Antenna



AECS1806C03Z

Request Samples



Check Inventory



181.7 x 68.9 x 69.1 mm
RoHS/RoHS II Compliant
MSL Level = 1

LTE

XY - Plane

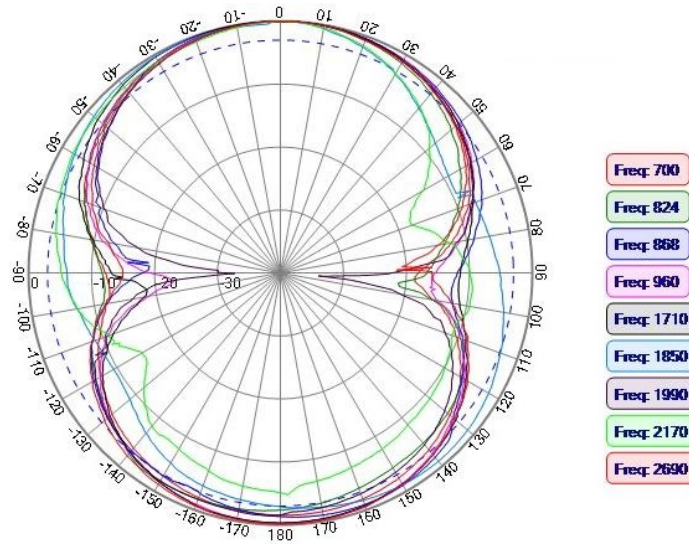

XZ - Plane

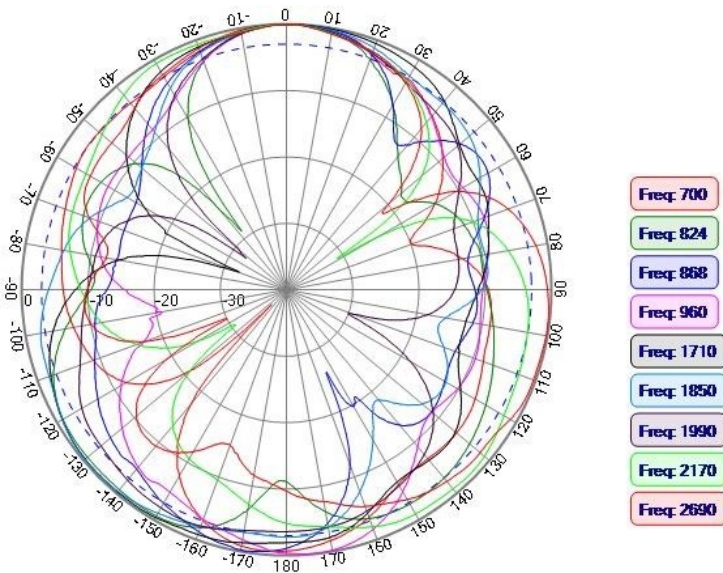

YZ - Plane

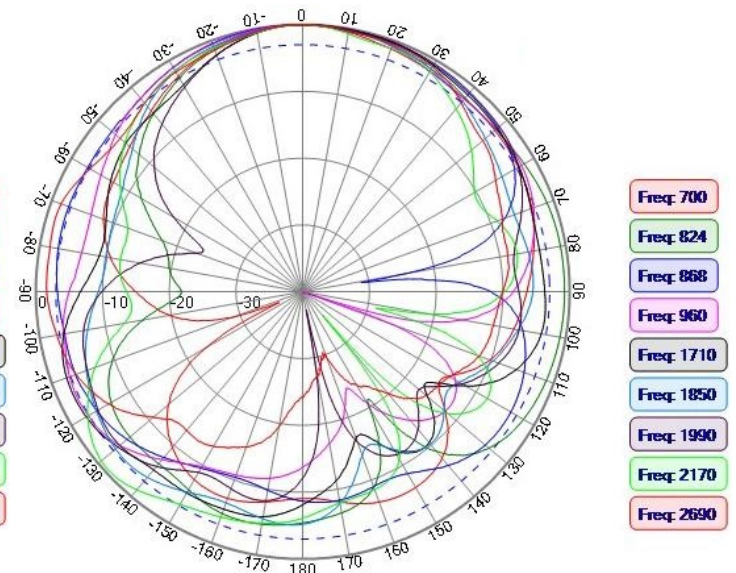

5101 Hidden Creek Ln Spicewood TX 78669
Phone: 512-371-6159 | Fax: 512-351-8858
For terms and conditions of sales, please visit:
www.abracon.com

REVISED: 05-08-20

ABRACON IS
ISO9001-2015
CERTIFIED

Automotive Grade LTE + Wi-Fi + GNSS External Combo Antenna



AECS1806C03Z

Request Samples



Check Inventory



181.7 x 68.9 x 69.1 mm
RoHS/RoHS II Compliant
MSL Level = 1

Wi-Fi

XY - Plane

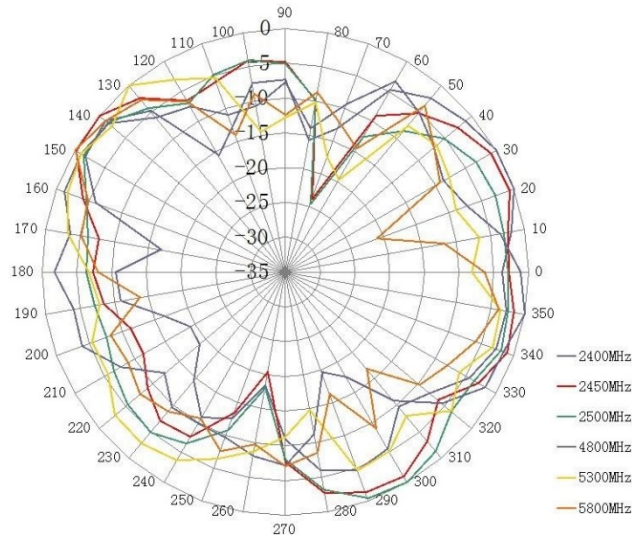

XZ - Plane

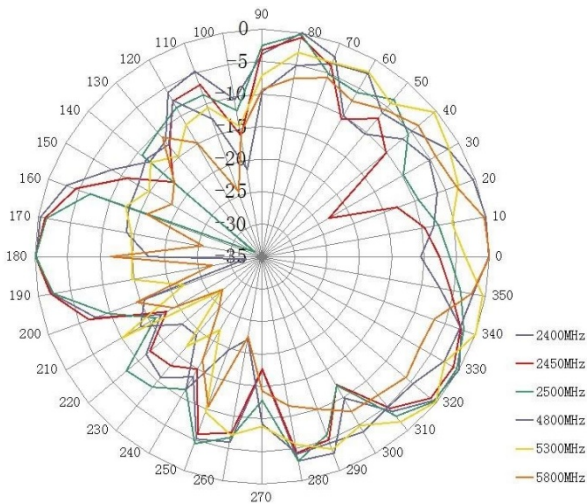

YZ - Plane

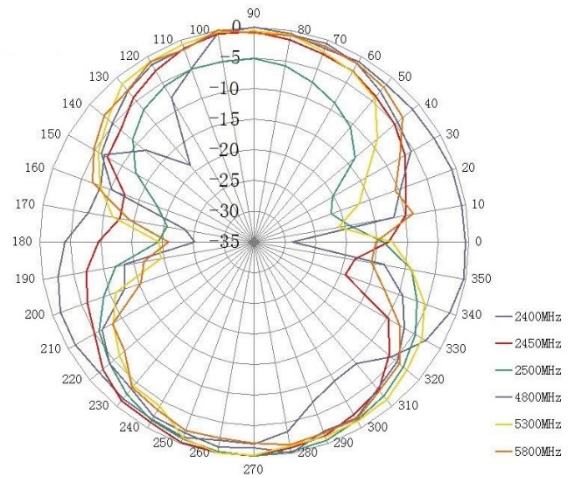

5101 Hidden Creek Ln Spicewood TX 78669
Phone: 512-371-6159 | Fax: 512-351-8858
For terms and conditions of sales, please visit:
www.abracon.com

REVISED: 05-08-20

ABRACON IS
ISO9001-2015
CERTIFIED

Automotive Grade LTE + Wi-Fi + GNSS External Combo Antenna



AECS1806C03Z

Request Samples



Check Inventory



181.7 x 68.9 x 69.1 mm
RoHS/RoHS II Compliant
MSL Level = 1

3D Pattern

LTE

698 MHz

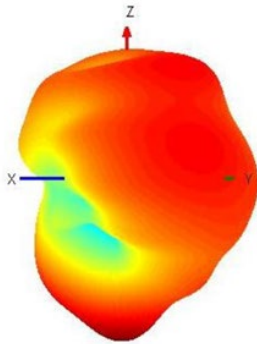

824 MHz

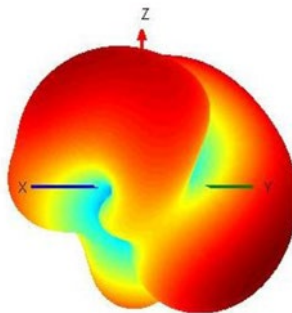

868 MHz

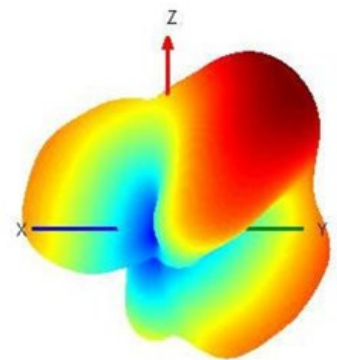

960 MHz

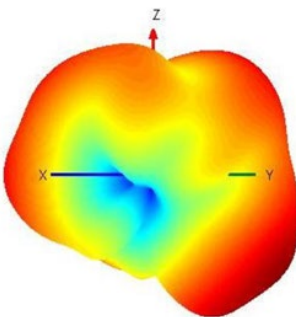

1710 MHz

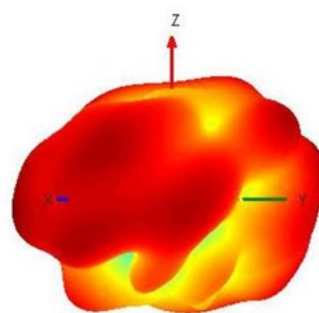

1850 MHz

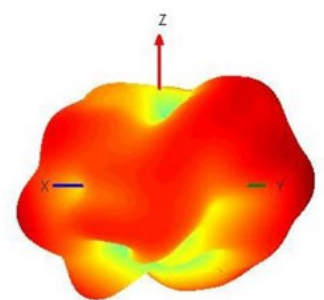

1990 MHz

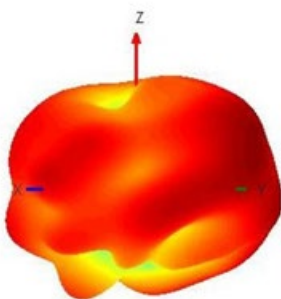

2170 MHz

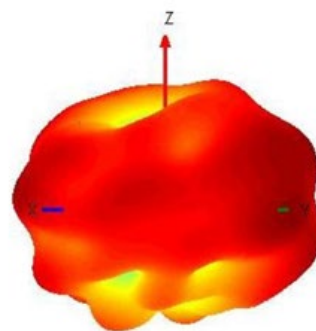

2690 MHz

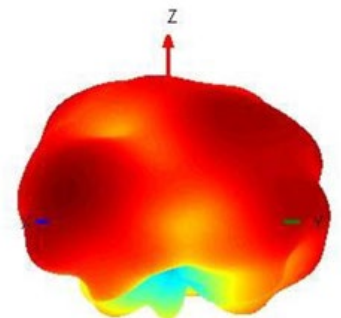

Automotive Grade LTE + Wi-Fi + GNSS External Combo Antenna



AECS1806C03Z

Request Samples



Check Inventory



181.7 x 68.9 x 69.1 mm
RoHS/RoHS II Compliant
 MSL Level = 1

Wi-Fi

2400 MHz

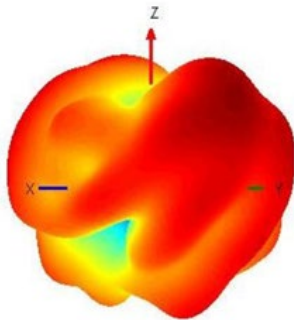

2440 MHz

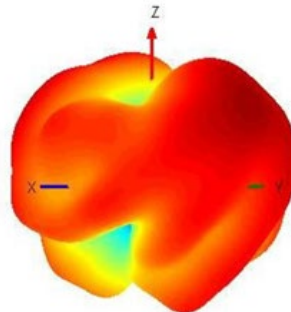

2483 MHz

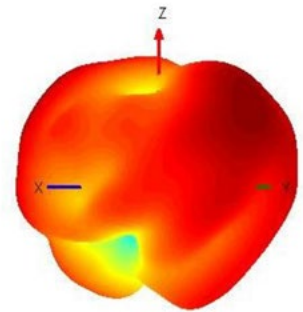

Gain and Efficiency

Frequency (MHz)	Gain (dBi)	Efficiency
LTE		
698	3.57	0.69
824	2.28	0.61
868	2.32	0.56
960	2.1	0.57
1710	1.11	0.57
1850	0.32	0.52
1990	0.75	0.57
2170	1.97	0.59
2690	0.94	0.58
Wi-Fi		
2400	2.07	0.56
2440	1.49	0.58
2483	1.85	0.54

Automotive Grade LTE + Wi-Fi + GNSS External Combo Antenna



AECS1806C03Z

Request Samples



Check Inventory



181.7 x 68.9 x 69.1 mm
RoHS/RoHS II Compliant
MSL Level = 1

Packaging Information

Number of Antenna/ Carton : 12 pcs
Weight of 1 pc of the antenna : 470 g
Dimension of the Carton : 495 x 220 x 270 mm
Weight of the carton : 6 kg

ATTENTION: Abracon LLC's products are COTS – Commercial-Off-The-Shelf products; suitable for Commercial, Industrial and, where designated, Automotive Applications. Abracon's products are not specifically designed for Military, Aviation, Aerospace, Life-dependent Medical applications or any application requiring high reliability where component failure could result in loss of life and/or property. For applications requiring high reliability and/or presenting an extreme operating environment, written consent and authorization from Abracon LLC is required. Please contact Abracon LLC for more information.



5101 Hidden Creek Ln Spicewood TX 78669
Phone: 512-371-6159 | Fax: 512-351-8858
For terms and conditions of sales, please visit:
www.abracon.com

REVISED: 05-08-20

ABRACON IS
ISO9001-2015
CERTIFIED