

KEMET Part Number: SSRH24NHS-30092
(UALS24HS300920)

KEMET, SSRH24NVS/NHS, AC Line Filters, Common Mode, 9200 uH

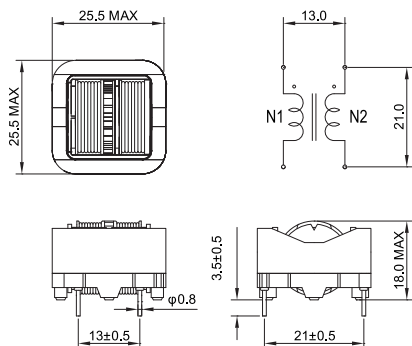

Dimensions

L	25.5mm MAX
T	25.5mm MAX
H	18mm MAX
LL	3.5mm +/-0.5mm
S	13mm NOM

Packaging Specifications

Packaging:	Tray
Packaging Quantity:	300
Weight:	22.5 g

General Information

Series:	SSRH24NVS/NHS
Style:	Through-Hole
Features:	Compact Size, Light Weight, High Performance, Low Rdc
RoHS:	Yes
Miscellaneous:	65 (K) Temperature Rise Max.

Specifications

Voltage AC:	250 VAC
Inductance:	9.2 mH (10 kHz)
Current:	3 A
Temperature Range:	-25/+120°C
DC Resistance:	79 mOhms