

# 300mA Low Dropout Linear Regulator

## ■ FEATURES

- Low Dropout Voltage of 470mV at 300mA Output Current (3.0V Output Version).
- Guaranteed 300mA Output Current.
- Maximum Input Voltage is 8V
- Low Ground Current at 55 $\mu$ A.
- 2% Accuracy Output Voltage of 1.5V/1.8V/ 2.0V /2.5V /2.7V/ 3.0V/ 3.3V/ 3.5V/ 3.7V/ 3.8V/ 5.0V/ 5.2V.
- Needs only 1 $\mu$ F for Stability.
- Current and Thermal Limiting.

## ■ APPLICATIONS

- Voltage Regulator for CD-ROM Drivers.
- Voltage Regulator for LAN Cards.
- Voltage Regulator for Microprocessor.
- Wireless Communication Systems.
- Battery Powered Systems.

## ■ TYPICAL APPLICATION CIRCUIT

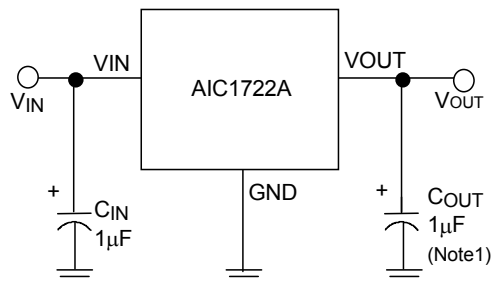

**Low Dropout Linear Regulator**

## ■ DESCRIPTION

The AIC1722A is a 3-pin low dropout linear regulator. The superior characteristics of the AIC1722A include zero base current loss, very low dropout voltage, and 2% accuracy output voltage. Typical ground current remains approximately 55 $\mu$ A, from no load to maximum loading conditions. Dropout voltage at 300mA output current is exceptionally low. Output current limiting and thermal limiting are built in to provide maximal protection to the AIC1722A against fault conditions.

The AIC1722A comes in the popular 3-pin SOT-89, TO-92 and SOT-23 packages.

**ORDERING INFORMATION**

AIC1722A-XXXXX XX

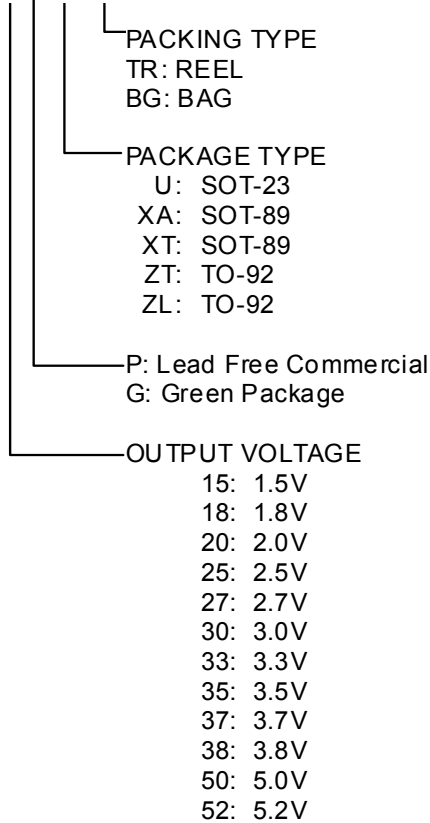

Example: AIC 1722A-18PXATR  
 → 1.8V Version, in SOT-89 Package & Tape & Reel Packing Type(lead free)

AIC 1722A-18GXATR  
 → 1.8V Version, in SOT-89 Lead Free Package & Tape & Reel Packing Type (green)

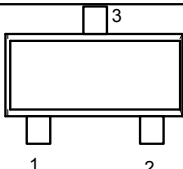
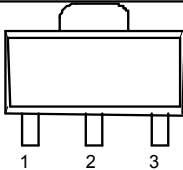
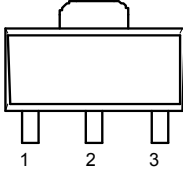
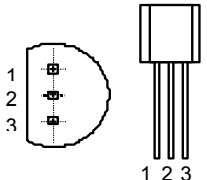
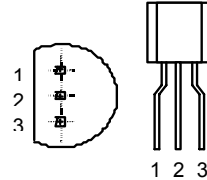
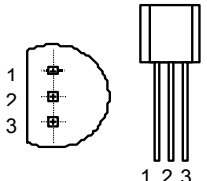
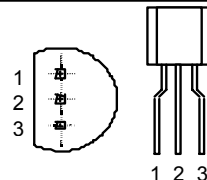
PIN CONFIGURATION	
SOT-23 (U) TOP VIEW 1: GND 2: VOUT 3: VIN	
SOT-89 (XA) TOP VIEW 1: GND 2: VIN 3: VOUT	
SOT-89 (XT) TOP VIEW 1: VOUT 2: GND 3: VIN	
TO-92 (ZTBG) TOP VIEW 1: GND 2: VIN 3: VOUT  * Straight lead option available in bag packing type only. * Refer to physical dimensions for lead pitch.	
TO-92 (ZTTR) TOP VIEW 1: GND 2: VIN 3: VOUT  * Formed lead option available in reel packing type. * Refer to physical dimensions for lead pitch.	
TO-92 (ZLBG) TOP VIEW 1: VIN 2: GND 3: VOUT  * Straight lead option available in bag packing type only. * Refer to physical dimensions for lead pitch.	
TO-92 (ZLBG) TOP VIEW 1: VIN 2: GND 3: VOUT  * Formed lead option available in reel packing type. * Refer to physical dimensions for lead pitch.	

**● SOT-23 MARKING**

Part No.	PU	GU	Part No.	PU	GU
AIC1722A-15XU	BN15P	BN15G	AIC1722A-33XU	BN33P	BN33G
AIC1722A-18XU	BN18P	BN18G	AIC1722A-35XU	BN35P	BN35G
AIC1722A-20XU	BN20P	BN20G	AIC1722A-37XU	BN37P	BN37G
AIC1722A-25XU	BN25P	BN25G	AIC1722A-38XU	BN38P	BN38G
AIC1722A-27XU	BN27P	BN27G	AIC1722A-50XU	BN50P	BN50G
AIC1722A-30XU	BN30P	BN30G	AIC1722A-52XU	BN52P	BN52G

**● SOT-89 MARKING**

Part No.	PXA	GXA	Part No.	PXT	GXT
AIC1722A-15XXA	AL15P	AL15G	AIC1722A-15XXT	BA15P	BA15G
AIC1722A-18XXA	AL18P	AL18G	AIC1722A-18XXT	BA18P	BA18G
AIC1722A-20XXA	AL20P	AL20G	AIC1722A-20XXT	BA20P	BA20G
AIC1722A-25XXA	AL25P	AL25G	AIC1722A-25XXT	BA25P	BA25G
AIC1722A-27XXA	AL27P	AL27G	AIC1722A-27XXT	BA27P	BA27G
AIC1722A-30XXA	AL30P	AL30G	AIC1722A-30XXT	BA30P	BA30G
AIC1722A-33XXA	AL33P	AL33G	AIC1722A-33XXT	BA33P	BA33G
AIC1722A-35XXA	AL35P	AL35G	AIC1722A-35XXT	BA35P	BA35G
AIC1722A-37XXA	AL37P	AL37G	AIC1722A-37XXT	BA37P	BA37G
AIC1722A-38XXA	AL38P	AL38G	AIC1722A-38XXT	BA38P	BA38G
AIC1722A-50XXA	AL50P	AL50G	AIC1722A-50XXT	BA50P	BA50G
AIC1722A-52XXA	AL52P	AL52G	AIC1722A-52XXT	BA52P	BA52G

**■ ABSOLUTE MAXIMUM RATINGS**

Input Supply Voltage .....	-0.3~8V
Operating Temperature Range .....	-40°C~ 85°C
Junction Temperature .....	125°C
Storage Temperature Range .....	-65°C~150°C
Lead Temperature (Soldering, 10sec) .....	260°C
Thermal Resistance Junction to Case	SOT-23.....130°C /W
	SOT-89.....30°C /W
	TO-92.....120°C /W
Thermal Resistance Junction to Ambient	SOT-23.....180°C /W
(Assume no ambient airflow, no heatsink)	SOT-89..... 160°C /W
	TO-92.....150°C /W

**Absolute Maximum Ratings are those values beyond which the life of a device may be impaired.**

## ■ TEST CIRCUIT

Refer to the TYPICAL APPLICATION CIRCUIT.

## ■ ELECTRICAL CHARACTERISTICS ( $T_A=25^\circ\text{C}$ , $C_{IN}=1\mu\text{F}$ , $C_{OUT}=1\mu\text{F}$ , unless otherwise specified.) (Note 2)

PARAMETER	TEST CONDITIONS	MIN.	TYP.	MAX.	UNIT
Output Voltage	$V_{IN}=8\text{V}$ , No Load	-2		+2	%
Line Regulation	$I_L=1\text{mA}$ , $1.4\text{V}\leq V_{OUT}\leq 3.2\text{V}$ $V_{IN}=4\text{V}\sim 8\text{V}$		3	10	mV
	$3.3\text{V}\leq V_{OUT}\leq 5.2\text{V}$ $V_{IN}=5.5\text{V}\sim 8\text{V}$		3	15	
Load Regulation (Note 3)	$I_L=0.1\sim 300\text{mA}$ $1.4\text{V}\leq V_{OUT}\leq 3.9\text{V}$ $V_{IN}=5\text{V}$		7	20	mV
	$4.0\text{V}\leq V_{OUT}\leq 5.2\text{V}$ $V_{IN}=7\text{V}$		15	40	
Current Limit (Note 4)	$V_{IN}=7\text{V}$ , $V_{OUT}=0\text{V}$	300			mA
Dropout Voltage (Note 5)	$I_L=300\text{mA}$	$4.0\text{V}\leq V_{OUT}\leq 5.2\text{V}$	400	500	mV
		$3.0\text{V}\leq V_{OUT}\leq 3.9\text{V}$	470	570	
		$2.5\text{V}\leq V_{OUT}\leq 2.9\text{V}$	570	670	
		$2.0\text{V}\leq V_{OUT}\leq 2.4\text{V}$	800	900	
		$1.4\text{V}\leq V_{OUT}\leq 1.9\text{V}$	1260	1360	
Ground Current	$I_O=0.1\text{mA}\sim I_{MAX}$ $1.4\text{V}\leq V_{OUT}\leq 3.9\text{V}$ $V_{IN}=5\sim 8\text{V}$		55	80	$\mu\text{A}$
	$4.0\text{V}\leq V_{OUT}\leq 5.2\text{V}$ $V_{IN}=7\sim 8\text{V}$		55	80	
Thermal Shutdown Hysteresis	Guaranteed by design		20		$^\circ\text{C}$

Note 1: To avoid output oscillation, aluminum electrolytic output capacitor is recommended and ceramic capacitor is not suggested.

Note 2: Specifications are production tested at  $T_A=25^\circ\text{C}$ . Specifications over the  $-40^\circ\text{C}$  to  $85^\circ\text{C}$  operating temperature range are assured by design, characterization and correlation with Statistical Quality Controls (SQC).

Note 3: Regulation is measured at constant junction temperature, using pulse testing with a low ON time.

Note 4: Current limit is measured by pulsing a short time.

Note 5: Dropout voltage is defined as the input to output differential at which the output voltage drops 100mV below the value measured with a 1V differential.

**TYPICAL PERFORMANCE CHARACTERISTICS**

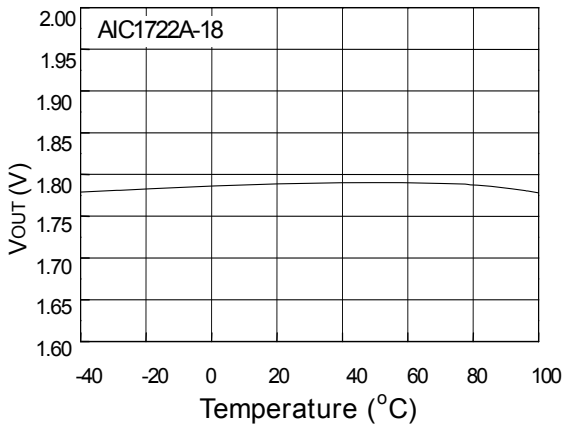

Fig. 1 V<sub>OUT</sub> vs. Temperature

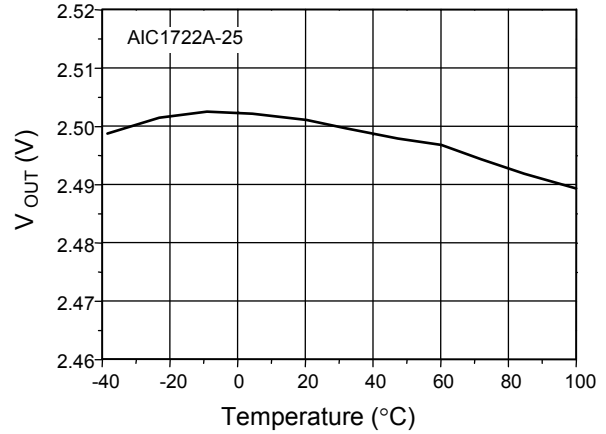

Fig. 2 V<sub>OUT</sub> vs. Temperature

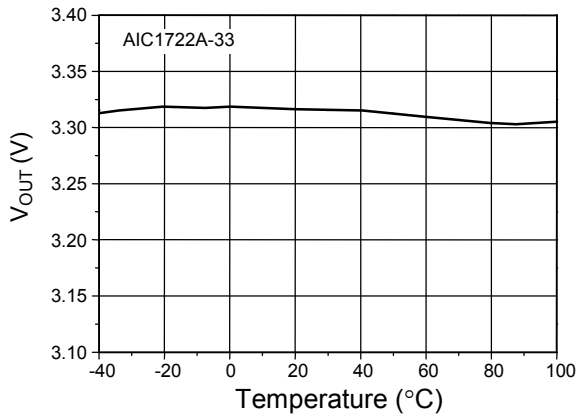

Fig. 3 V<sub>OUT</sub> vs. Temperature

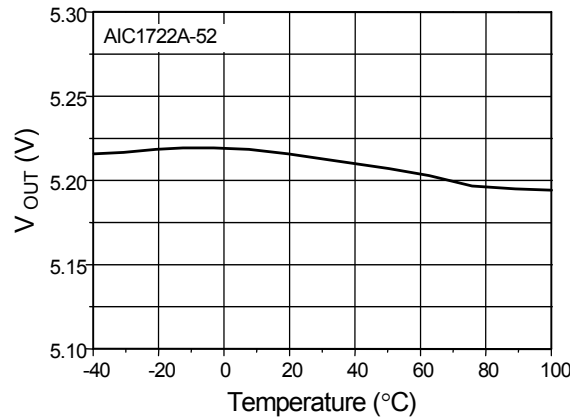

Fig. 4 V<sub>OUT</sub> vs. Temperature

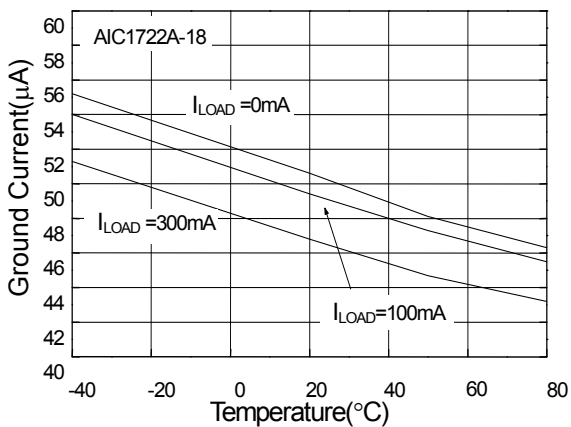

Fig. 5 Ground Current vs. Temperature

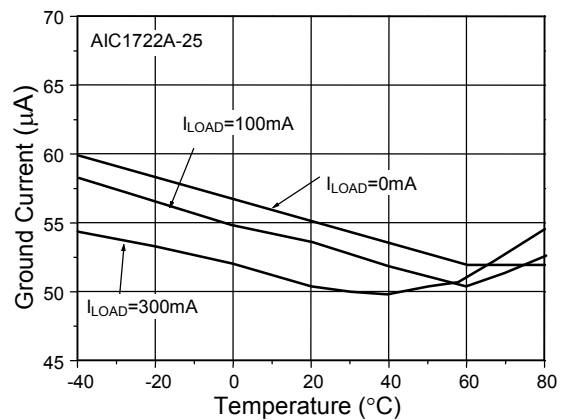

Fig. 6 Ground Current vs. Temperature

■ **TYPICAL PERFORMANCE CHARACTERISTICS (Continued)**

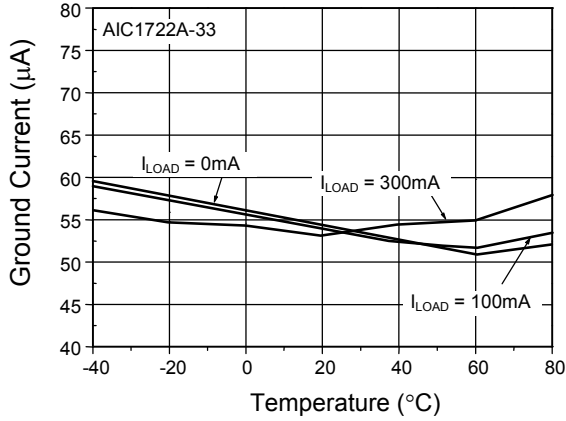

Fig. 7 Ground Current vs. Temperature

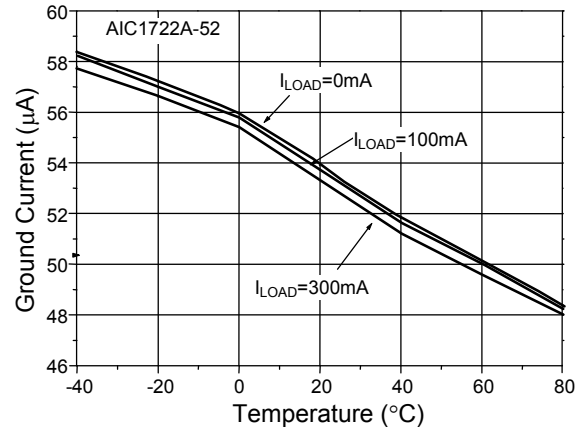

Fig. 8 Ground Current vs. Temperature

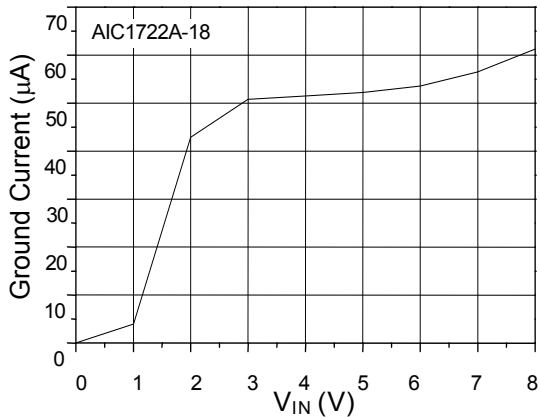

Fig. 9 Ground Current vs.  $V_{IN}$

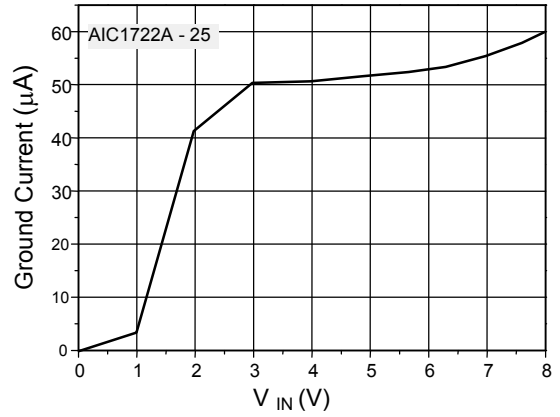

Fig. 10 Ground Current vs.  $V_{IN}$

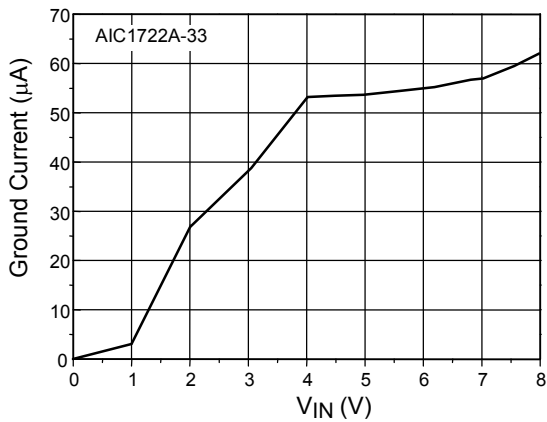

Fig. 11 Ground Current vs.  $V_{IN}$

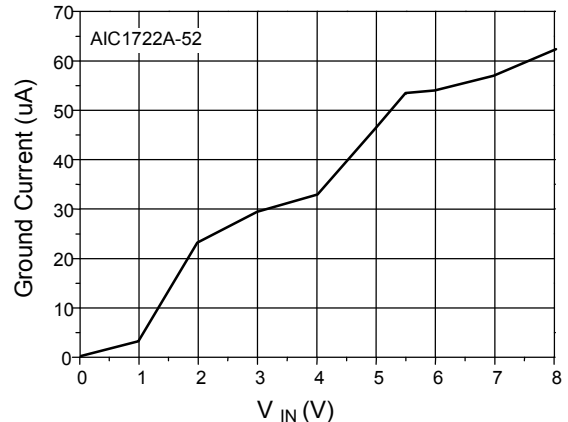

Fig. 12 Ground Current vs.  $V_{IN}$

■ **TYPICAL PERFORMANCE CHARACTERISTICS (Continued)**

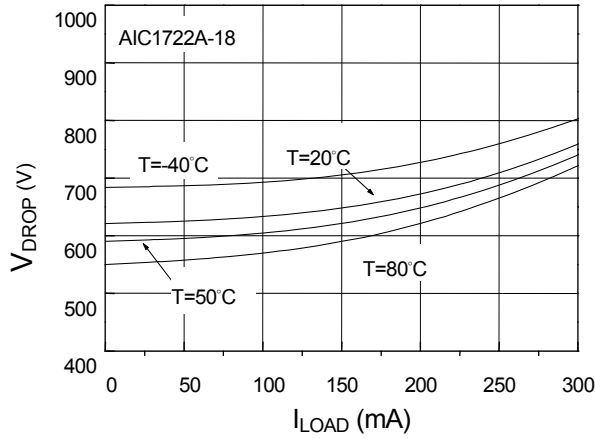

Fig. 13  $V_{DROP}$  vs.  $I_{LOAD}$

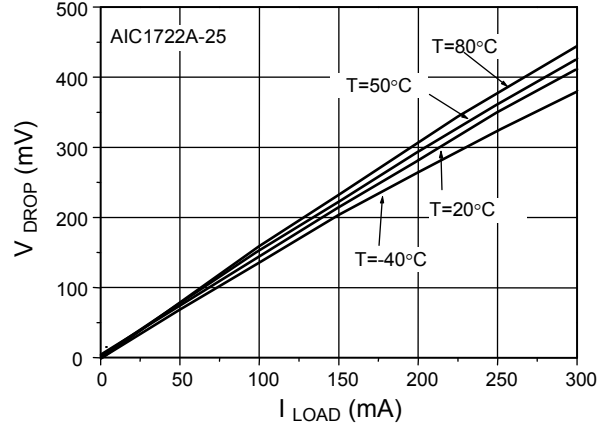

Fig. 14  $V_{DROP}$  vs.  $I_{LOAD}$

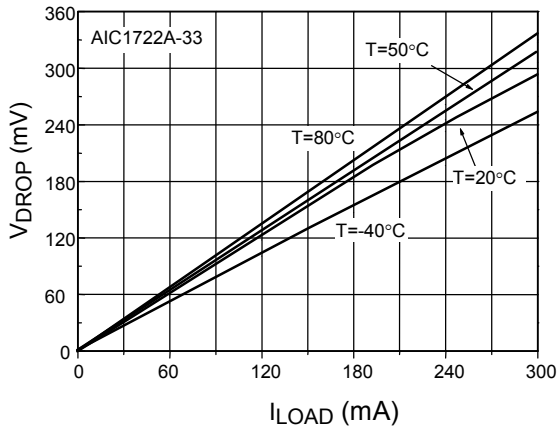

Fig. 15  $V_{DROP}$  vs.  $I_{LOAD}$

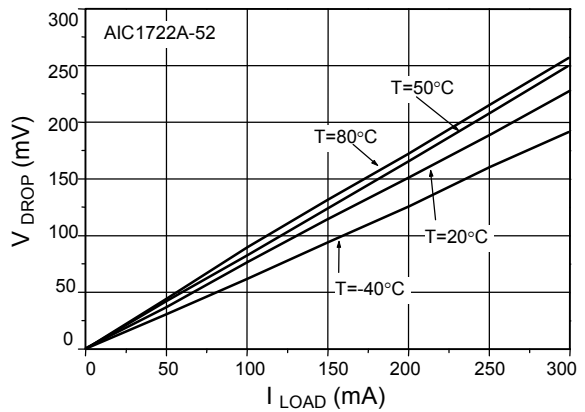

Fig. 16  $V_{DROP}$  vs.  $I_{LOAD}$

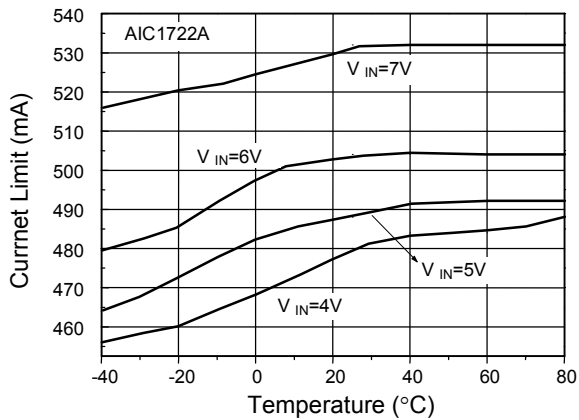
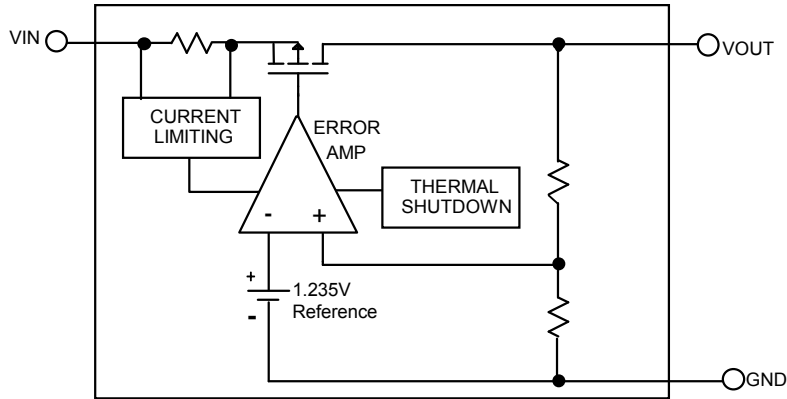

Fig. 17 Current Limit vs. Temperature

**■ BLOCK DIAGRAM**



**■ PIN DESCRIPTIONS**

VOUT PIN - Output pin.

GND PIN - Power GND.

VIN PIN - Power Supply Input.



## ■ APPLICATION INFORMATION

### INPUT-OUTPUT CAPACITORS

Linear regulators require input and output capacitors to maintain stability. Input capacitor at 1 $\mu$ F with 1 $\mu$ F aluminum electrolytic output capacitor is recommended.

### POWER DISSIPATION

The AIC1722A obtains thermal-limiting circuitry, which is designed to protect the device against overload condition. For continuous load condition, maximum rating of junction temperature must not be exceeded. It is important to pay more attention in thermal resistance. It includes junction to case, junction to ambient. The maximum power dissipation of AIC1722A depends on the thermal resistance of its case and circuit board, the temperature difference between the die junction and ambient air, and the rate of airflow. The rate of temperature rise is greatly affected by the mounting pad configuration on the PCB, the board material, and the ambient temperature. When the IC mounting with good thermal

conductivity is used, the junction temperature will be low even when large power dissipation applies.

The power dissipation across the device is

$$P = I_{OUT} (V_{IN} - V_{OUT}).$$

The maximum power dissipation is:

$$P_{MAX} = \frac{(T_{J-max} - T_A)}{R\theta_{JA}}$$

Where  $T_{J-max}$  is the maximum allowable junction temperature (125°C), and  $T_A$  is the ambient temperature suitable in application.

As a general rule, the lower temperature is, the better reliability of the device is. So the PCB mounting pad should provide maximum thermal conductivity to maintain low device temperature.

GND pin performs a dual function for providing an electrical connection to ground and channeling heat away. Therefore, connecting the GND pin to ground with a large pad or ground plane would increase the power dissipation and reduce the device temperature.

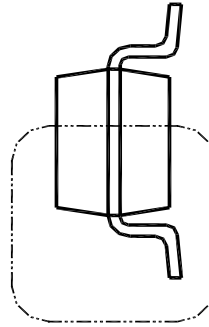
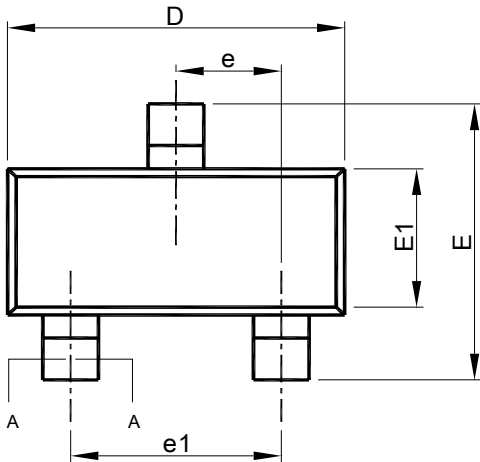
**PHYSICAL DIMENSIONS (unit: mm)**
**SOT-23**

SEE VIEW B

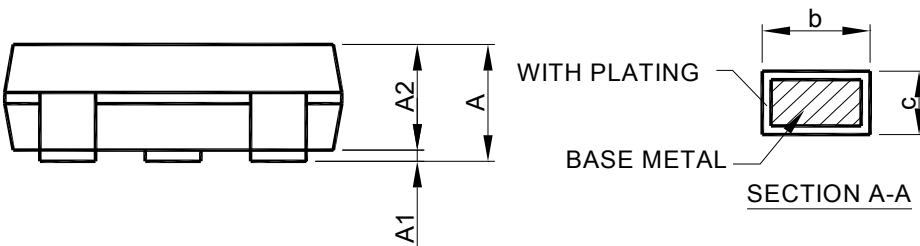
 WITH PLATING  
 BASE METAL

SECTION A-A

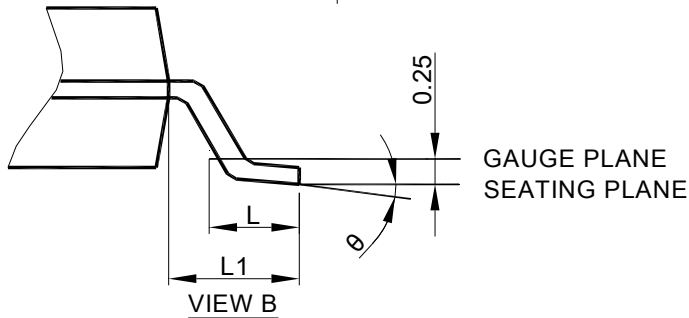
 GAUGE PLANE  
 SEATING PLANE

- Note: 1. Refer to JEDEC MO-178.  
 2. Dimension "D" does not include mold flash, protrusions or gate burrs. Mold flash, protrusion or gate burrs shall not exceed 10 mil per side.  
 3. Dimension "E1" does not include inter-lead flash or protrusions.  
 4. Controlling dimension is millimeter, converted inch dimensions are not necessarily exact.

SYMBOL	SOT-23	
	MILLIMETERS	
	MIN.	MAX.
A	0.95	1.45
A1	0.00	0.15
A2	0.90	1.30
b	0.30	0.50
c	0.08	0.22
D	2.80	3.00
E	2.60	3.00
E1	1.50	1.70
e	0.95 BSC	
e1	1.90 BSC	
L	0.30	0.60
L1	0.60 REF	
θ	0°	8°

● SOT-89

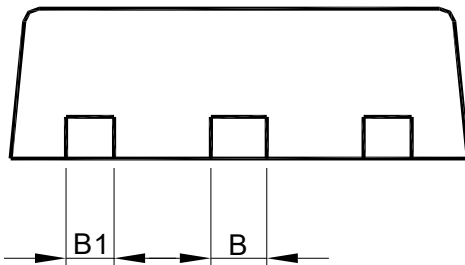
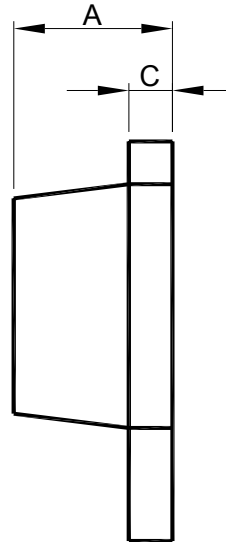
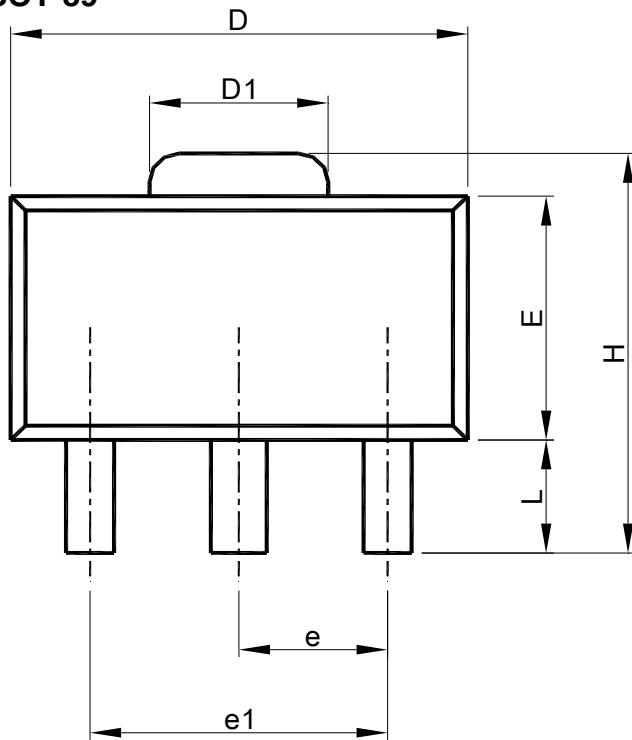

SYMBOL	SOT-89	
	MILLIMETERS	
	MIN.	MAX.
A	1.40	1.60
B	0.44	0.56
B1	0.36	0.48
C	0.35	0.44
D	4.40	4.60
D1	1.50	1.83
E	2.29	2.60
e	1.50 BSC	
e1	3.00 BSC	
H	3.94	4.25
L	0.89	1.20

- Note: 1. Refer to JEDEC TO-243AA.  
 2. Dimension "D" does not include mold flash, protrusions or gate burrs. Mold flash, protrusion or gate burrs shall not exceed 6 mil per side.  
 3. Dimension "E" does not include inter-lead flash or protrusions.  
 4. Controlling dimension is millimeter, converted inch dimensions are not necessarily exact.

- TO-92 (Straight lead option available in Bag packing type only)

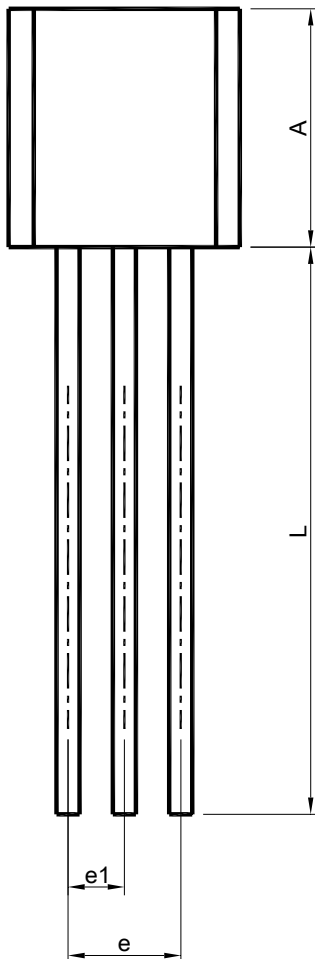
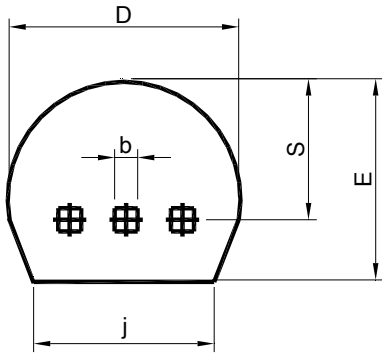

SYMBOL	TO-92	
	MILLIMETERS	
	MIN.	MAX.
A	4.32	5.33
b	0.36	0.47
D	4.45	5.20
E	3.18	4.19
e	2.42	2.66
e1	1.15	1.39
j	3.43	
L	12.70	
S	2.03	2.66

- Note: 1. Refer to JEDEC TO-226.  
 2. Dimension "D" does not include mold flash, protrusions or gate burrs. Mold flash, protrusion or gate burrs shall not exceed 6 mil per side .  
 3. Dimension "A" does not include inter-lead flash or protrusions.  
 4. Controlling dimension is millimeter, converted inch dimensions are not necessarily exact.

- TO-92 (Formed lead option available in Reel packing)

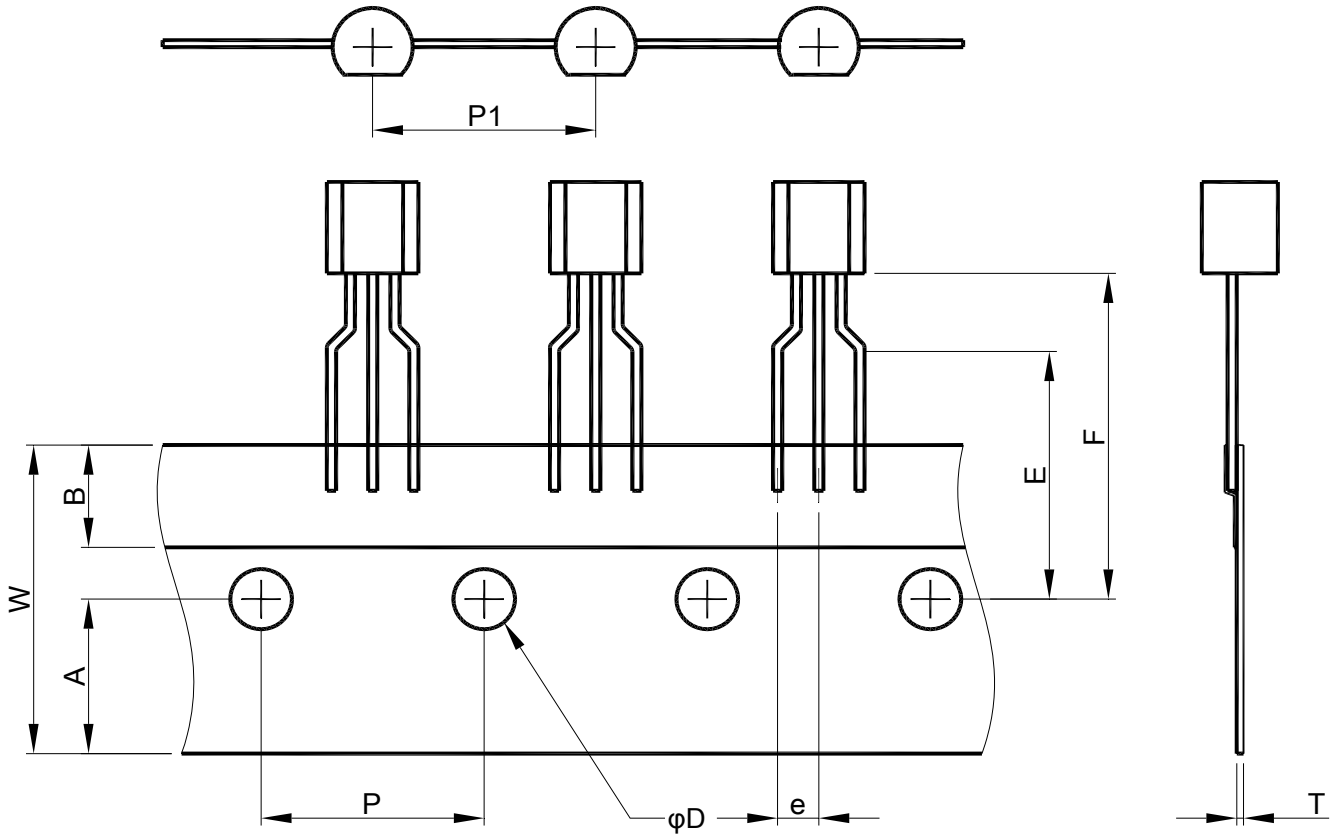

SYMBOL	W	A	B	E	F
SPEC.	18.0±0.2	9.0±0.2	6.0±0.20	16.0±0.5	19.0±0.5
SYMBOL	P	P1	D	e	T
SPEC.	12.7 BSC	12.7 BSC	4.0±0.2	2.5 BSC	0.6±0.1

**Note:**

Information provided by AIC is believed to be accurate and reliable. However, we cannot assume responsibility for use of any circuitry other than circuitry entirely embodied in an AIC product; nor for any infringement of patents or other rights of third parties that may result from its use. We reserve the right to change the circuitry and specifications without notice.

Life Support Policy: AIC does not authorize any AIC product for use in life support devices and/or systems. Life support devices or systems are devices or systems which, (i) are intended for surgical implant into the body or (ii) support or sustain life, and whose failure to perform, when properly used in accordance with instructions for use provided in the labeling, can be reasonably expected to result in a significant injury to the user.