



# XE125 Evaluation Board Product Brief



XE125 Evaluation Board Product Brief

Author: Acconeer

Version 1.0: 2023-03-29

Acconeer AB



## Table of Contents

1. Introduction .....	4
2. XE125 Evaluation Board.....	5
2.1. Overview .....	5
2.2. Power.....	6
2.3. Not Mounted Components .....	7
2.4. Connectors.....	7
2.4.1. Power pin header (J8).....	7
2.4.2. 2x5 JTAG/SWD pin header (J6) .....	7
2.4.3. 2x10 pin header (J2).....	8
2.5. Switches and buttons .....	8
2.6. Electrical Schematic .....	10
2.7. Bill of Material .....	14
2.8. Component Placement Drawing.....	14
3. Safety.....	17
3.1. Electrostatic precautions.....	17
4. Revision History.....	18
5. Disclaimer .....	19



# 1. Introduction

This document describes the Acconeer XE125 Evaluation board containing the XM125 Entry+ module. The evaluation board provides access to the interfaces from the XM125 Entry+ module so that it can easily be flashed and debugged. The XE125 is compatible with Acconeer LH132 lens kit (LH132 is also compatible with evaluation kit XE132). LH132 is sold separately. For more information please read:

- [XM125 Datasheet](#)
- [Acconeer XE125 Entry+ Module EVK HW User Guide](#)



## 2. XE125 Evaluation Board

### 2.1. Overview

The XE125 is an evaluation board including the XM125 Entry+ module. It makes the interfaces from the XM125 module accessible for evaluation and debug. It also enables flashing of the XM125 via USB-UART or SW-DP. The XM125 Entry+ module is included in the XE125 Evaluation board. In Picture 1 you will find the XE125 front side where the XM125 is mounted. Picture 2 shows the back side of XE125.

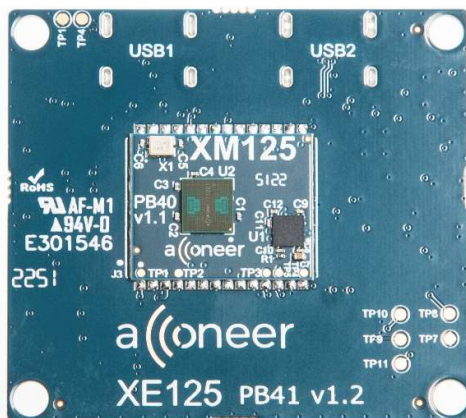

Picture 1. The XE125 top side where XM125 is mounted.

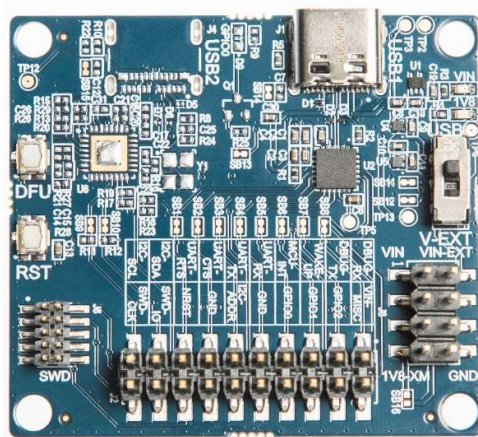

Picture 2. The XE125 back side.

In Figure 1 the block-diagram of the XE125 is shown.

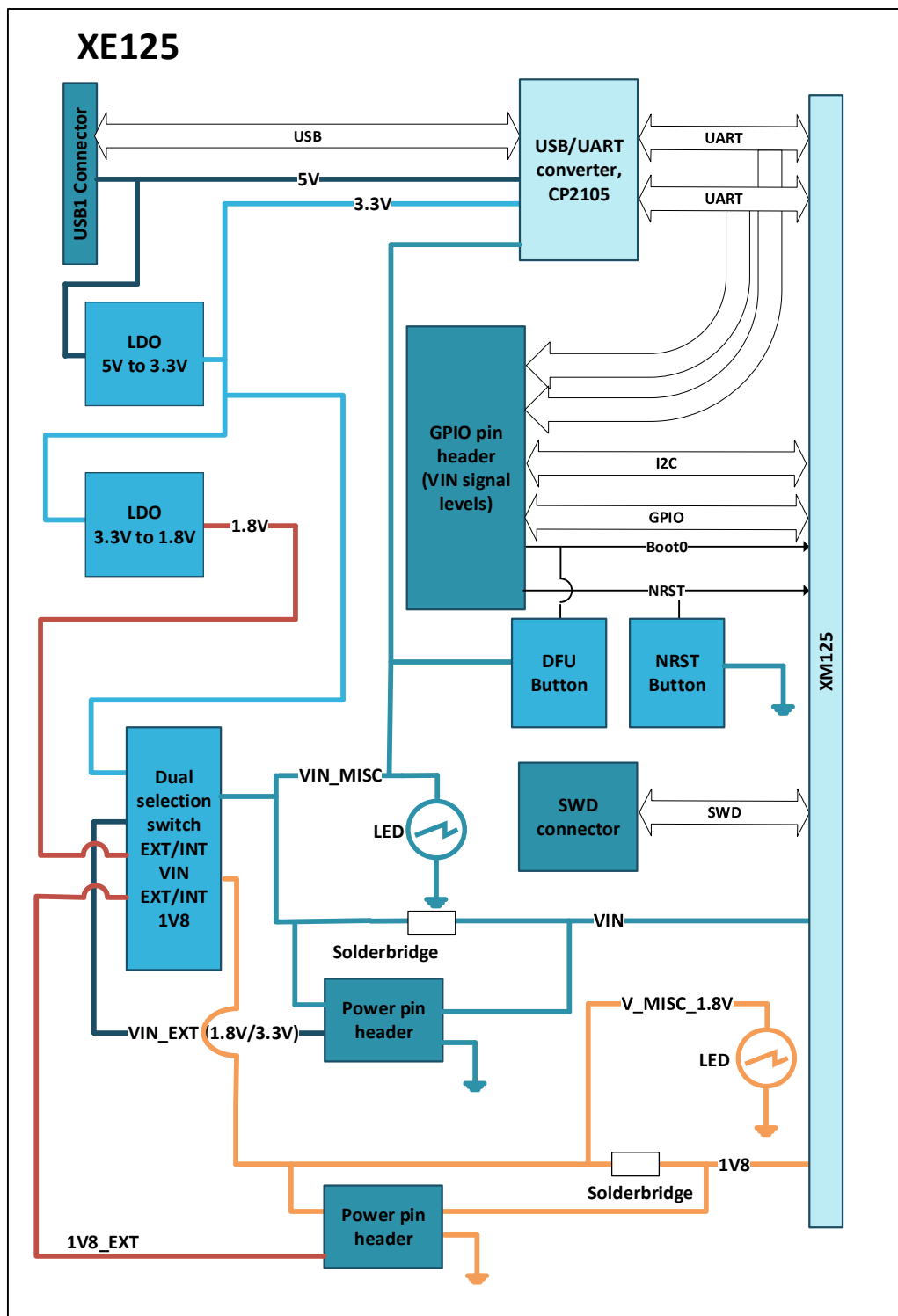

Figure 1 The block-diagram of the XE125.

## 2.2. Power

In the text below, the reference designators refer to the Electrical Schematic of XE125 in chapter 2.6.



The XE125 is powered via the USB connector J1 and/or via the pin header J8. The USB 5V power domain supplies the USB-UART chip (U2). If the USB-UART interface is not used, a dedicated USB charger can be used.

The XM125 module mounted on the XE125 can be powered either from on-board linear regulators U4 (3.3V LDO) and U5 (1.8V LDO) which are supplied from the USB 5V power domain or from “VIN\_EXT” and 1V8\_EXT in the J8 pin header. VIN\_EXT can be either 1.8V or 3.3V.

The power source for XM125 is determined by the setting of the switch “SW3”. When the LEDs D4 and D8 on the XE125 are lit, both power domains (VIN and 1V8) of the XM125 are powered.

It should be noted that regardless whether “VIN\_EXT” or the internal LDOs on XE125 are used to power XM125, the LEDs D4 and D8 will consume power since they are connected to “VIN\_MISC” and V\_MISC\_1V8 respectively. If one wants to measure only the current consumed by XM125, power should be supplied to XE125 via the pins “VIN\_XM125” and 1V8\_XM125 (pins 3 and 7 in pin header J8). In this case, the solder-bridges “SB11” and “SB12” should be cut. This way, all components on XE125 are supplied from the on-board LDOs, but XM125 is supplied from the external power supplies. D4 and D8 will not indicate if XM125 is powered after SB11 and SB12 have been cut.

The intention of the power pin header J8 is that it can be used both for supplying power to XM125 and for measuring current over a measurement resistor. SB11 and SB12 are short-circuited solder-bridges, but the user can change it to a low-value measurement resistor with high accuracy to perform very accurate measurements of the XM125 current. See Table 1 for the pin assignment of pin header J8.

## 2.3. Not Mounted Components

As can be seen in the schematic in chapter 2.6, USB connector J4 and several other components are “No Mount”. These components are related to the FTDI I2C-USB bridge chip FT4222H which can be mounted on the PCB. It was added for internal Acconeer use. The I2C interface is also accessible in pin header J2. Refer to Table 3.

## 2.4. Connectors

### 2.4.1. Power pin header (J8)

The power pin header J8 provides the possibility to supply the XM125 module with power from external power supplies. In Table 1, the pin assignment of J8 is shown:

**Table 1. The pin assignment of the power pin header J8.**

Pin Number	Signal	Pin Number	Signal
1	VIN_MISC	2	VIN_EXT
3	VIN_XM125	4	GND
5	V_MISC_1V8	6	1V8_EXT
7	1V8_XM125	8	GND

### 2.4.2. 2x5 JTAG/SWD pin header (J6)

The 2x5 JTAG/SWD pin header (1.27mm pitch) contains the signals needed for flashing the XM125 MCU via the SWD interface. The pinout matches that of the Cortex 10-pin JTAG/SWD Connector and is found in Table 2.



Table 2. The pinout of J6.

Pin Number	Signal	Pin Number	Signal
1	VIN	2	SWD_IO
3	GND	4	SWD_CLK
5	GND	6	NC (no TRACESWO available)
7	NC	8	NC
9	GND	10	NRESET

### 2.4.3. 2x10 pin header (J2)

The 2x10 pin header (2.54mm pitch) contains the interface and GPIOs from the XM125. All signals are on the VIN\_MISC voltage level (3.3V if on-board LDO used, otherwise VIN = 1.8 or 3.3V). The pinout is found in Table 3.

Table 3. The pinout of J2.

Pin Number	Signal	Pin Number	Signal
1	DEBUG_UART_RX <sup>1</sup>	2	VIN_MISC
3	DEBUG_UART_TX <sup>2</sup>	4	MISC_GPIO2_BOOT0
5	UART_RX <sup>1</sup>	6	MISC_GPIO1
7	WAKE_UP	8	MISC_GPIO0
9	MCU_INT	10	GND
11	UART_TX <sup>2</sup>	12	I2C_ADDRESS
13	UART_CTS <sup>3</sup>	14	GND
15	UART_RTS <sup>4</sup>	16	NRESET
17	I2C_SDA	18	SWD_IO
19	I2C_SCL	20	SWD_CLK

## 2.5. Switches and buttons

There is one switch on XE125. SW3 determines if XM125 is powered from the XE125 on-board LDOs (U4 and U5) or from external power supplies via pin header J8 (VIN\_EXT/1V8\_EXT).

There are two buttons on the XE125. SW1 controls the signal “BOOT0” connected to XM125 and SW2 controls “NRESET” connected to the XM125. In Table 4 the state of the buttons and the corresponding signal states are listed.

<sup>1</sup> UART\_RX is connected to UART\_RX on XM125. If external UART device is connected, this pin should be connected to TX of external device.

<sup>2</sup> UART\_TX is connected to UART\_TX on XM125. If external UART device is connected, this pin should be connected to RX of external device.

<sup>3</sup> UART\_CTS is connected to UART\_CTS on XM125. If external UART device is connected, this pin should be connected to RTS of external device.

<sup>4</sup> UART\_RTS is connected to UART\_RTS on XM125. If external UART device is connected, this pin should be connected to CTS of external device.





**Table 4. The states of the buttons SW1 and SW2.**

<b>Button</b>	<b>Open (default)</b>	<b>Closed</b>
SW1	BOOT0=0	BOOT0=1
SW2	NRST=1	NRST=0



## 2.6. Electrical Schematic

On the following pages, please find the Electrical Schematic for XE125:

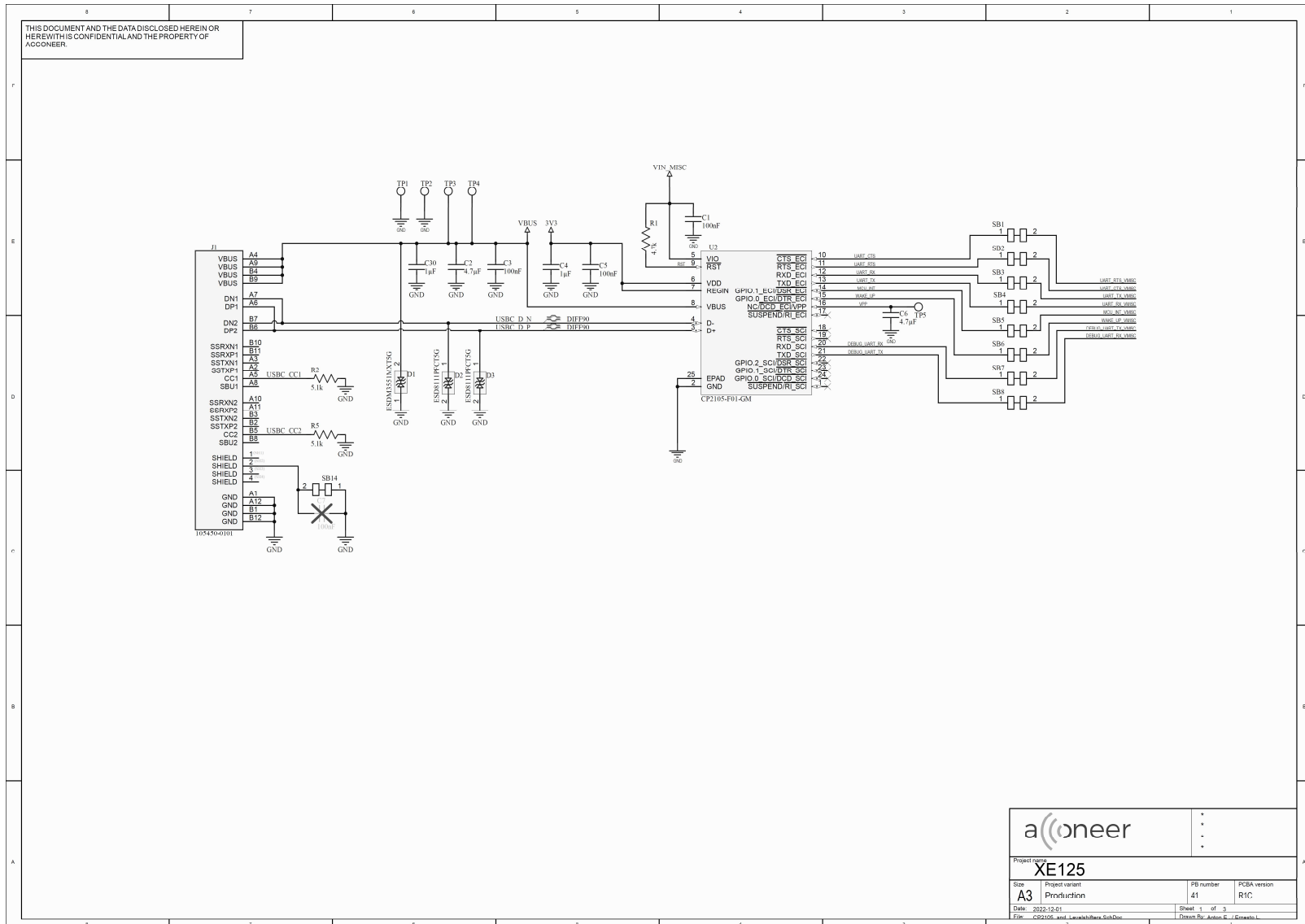

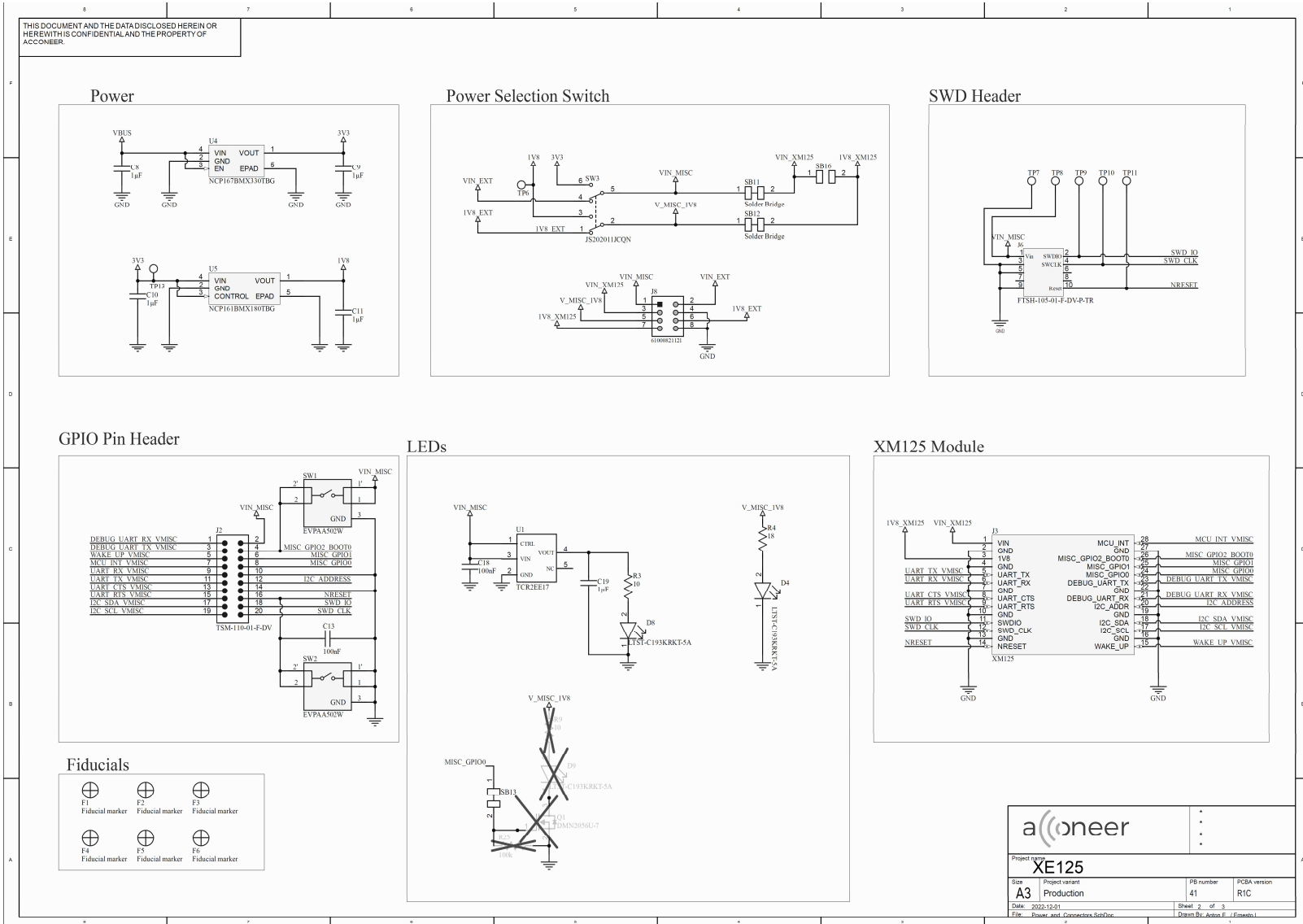

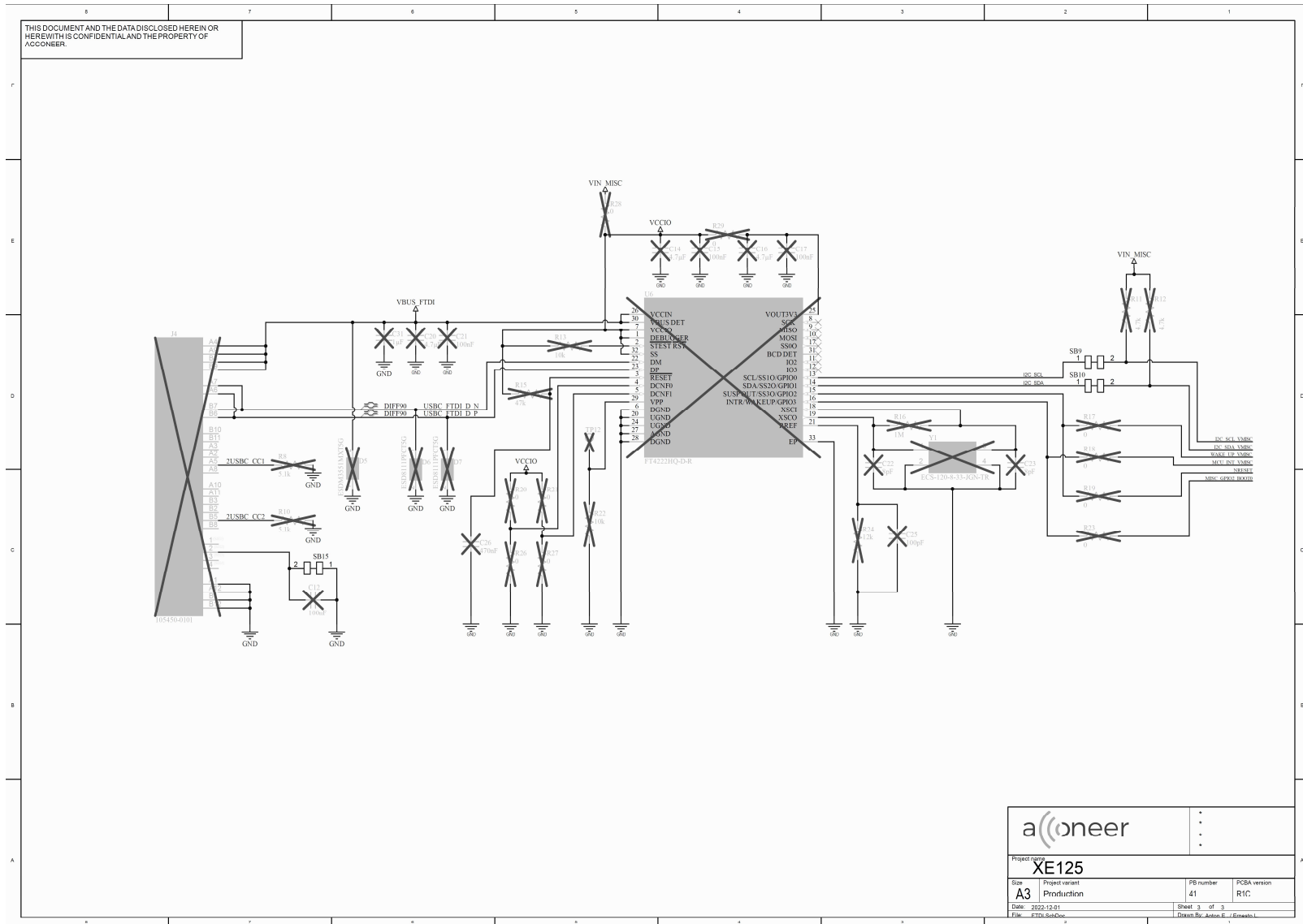



## 2.7. Bill of Material

Table 5 shows the BOM for the XE125

**Table 5 The BOM for the XE125.**

Designator	Name	Qty	Value	Tolerance	Voltage rating	Manufacturer
C4, C8, C9, C10, C11, C19, C30	Capacitor 1uF, metric 1005	7	1 $\mu$ F	20%	10V	
C2, C6	Capacitor 4.7uF, metric 1005	2	4.7 $\mu$ F	20%	10V	
C1, C3, C5, C13, C18	Capacitor 100nF, metric 1005	5	100nF	20%	10V	
R1	Resistor 4.7 kOhm, metric 1005	1	4.7k	1%		
R2, R5	Resistor 5.1 KOhm, metric 1005	2	5.1k	1%		
R3	Resistor 10 Ohm, metric 1005	1	10	1%		
R4	Resistor 18 Ohm, metric 1005	1	18	1%		
D1	ESDM3551MXT5G	1				ON Semiconductor
D2, D3	ESD8111PFCT5G	2				ON Semiconductor
D4, D8	LTST-C193KRKT-5A	2				Vishay Lite-On
SW1, SW2	EVPA4502W	2				Panasonic
SW3	JS202011JCQN	1				ITT C&K
U1	TCR2EE17	1				Toshiba Semiconductor
U2	CP2105-F01-GM	1				Silicon Labs
U4	NCP167BMX330TBG	1				ON Semiconductor
U5	NCP161BMX180TBG	1				ON Semiconductor
J1	105450-0101	1				Molex
J2	TSM-110-01-F-DV	1				Samtec
J3	XM125	1				
J6	FTSH-105-01-F-DV-P-TR	1				Samtec
J8	61000821121	1				Würth Electronics

## 2.8. Component Placement Drawing

In Picture 3 and Picture 4 the component placement drawing of XE125, top and bottom side, are found:

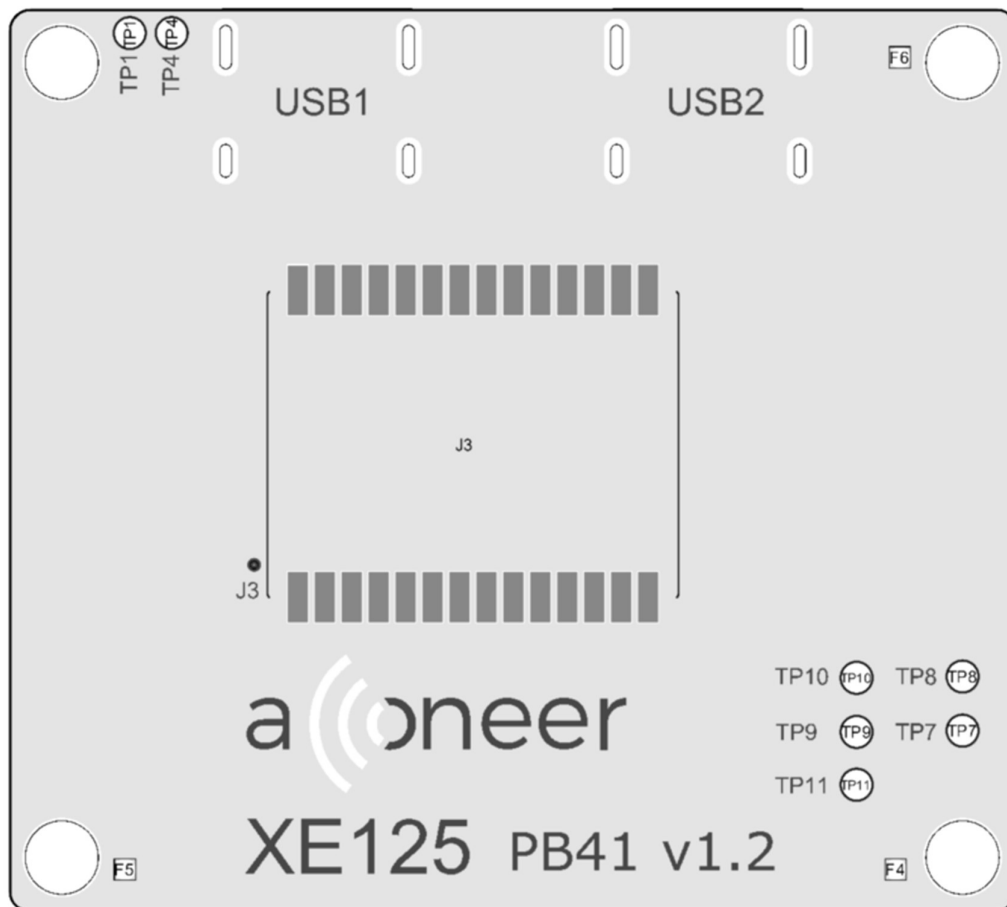

Picture 3. The component placement of XE125 top side.

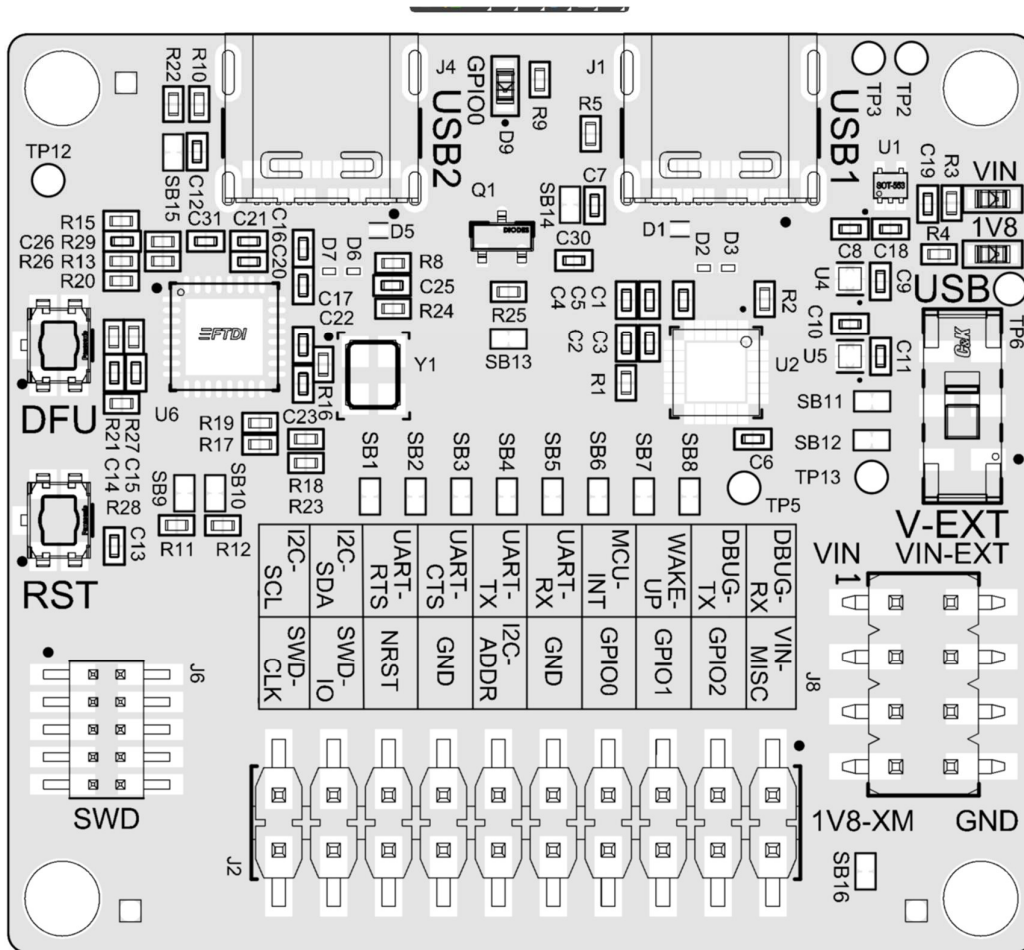

Picture 4. The component placement of XE125 bottom side.





## 3. Safety

### 3.1. Electrostatic precautions



Please take electrostatic precautions, including using ground straps, when using the EVK or any of its components. An electrostatic discharge could damage the device.



## 4. Revision History

Date	Revision	Changes
2023-03-30	1.0	Original version



## 5. Disclaimer

The information herein is believed to be correct as of the date issued. Acconeer AB (“**Acconeer**”) will not be responsible for damages of any nature resulting from the use or reliance upon the information contained herein. Acconeer makes no warranties, expressed or implied, of merchantability or fitness for a particular purpose or course of performance or usage of trade. Therefore, it is the user’s responsibility to thoroughly test the product in their particular application to determine its performance, efficacy and safety. Users should obtain the latest relevant information before placing orders.

Unless Acconeer has explicitly designated an individual Acconeer product as meeting the requirement of a particular industry standard, Acconeer is not responsible for any failure to meet such industry standard requirements.

Unless explicitly stated herein this document Acconeer has not performed any regulatory conformity test. It is the user’s responsibility to assure that necessary regulatory conditions are met and approvals have been obtained when using the product. Regardless of whether the product has passed any conformity test, this document does not constitute any regulatory approval of the user’s product or application using Acconeer’s product.

Nothing contained herein is to be considered as permission or a recommendation to infringe any patent or any other intellectual property right. No license, express or implied, to any intellectual property right is granted by Acconeer herein.

Acconeer reserves the right to at any time correct, change, amend, enhance, modify, and improve this document and/or Acconeer products without notice.

This document supersedes and replaces all information supplied prior to the publication hereof.



Acconeer AB  
Västra Varvsgatan 19  
211 77 Malmö  
Sweden

[www.acconeer.com](http://www.acconeer.com)  
[info@acconeer.com](mailto:info@acconeer.com)  
+46 10 218 92 00

# Mouser Electronics

Authorized Distributor

Click to View Pricing, Inventory, Delivery & Lifecycle Information:

[Acconeer:](#)

[XE125](#)