



SS10150FL-AU

Surface Mount Schottky Barrier Rectifier

Voltage 150 V **Current** 1 A

Features

- Low power loss, high efficiency
- High surge current capability
- AEC-Q101 qualified
- Lead free in compliance with EU RoHS 2.0
- Green molding compound as per IEC 61249 standard

Mechanical Data

- Case : SOD-123FL Package
- Terminals : Solderable per MIL-STD-750, Method 2026
- Approx. Weight : 0.0173 grams

SOD-123FL

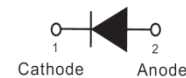

Maximum Ratings and Thermal Characteristics (T_A = 25 °C unless otherwise noted)

PARAMETER	SYMBOL	LIMIT	UNITS
Maximum Repetitive Peak Reverse Voltage	V _{RRM}	150	V
Maximum RMS Voltage	V _{RMS}	105	V
Maximum DC Blocking Voltage	V _{DC}	150	V
Maximum Average Forward Current	I _{F(AV)}	1	A
Peak Forward Surge Current : 8.3 ms Single Half Sine-Wave Superimposed On Rated Load	I _{FSM}	30	A
Typical Junction Capacitance Measured at 1 MHZ And Applied V _R = 4 V	C _J	40	pF
Typical Thermal Resistance	(Note 1) R _{θJA}	200	°C/W
	(Note 2) R _{θJC}	32	
	(Note 2) R _{θJL}	32	
Operating Junction Temperature Range	T _J	-55~150	°C
Storage Temperature Range	T _{STG}	-55~150	°C



SS10150FL-AU

Electrical Characteristics ($T_A = 25^\circ\text{C}$ unless otherwise noted)

PARAMETER	SYMBOL	TEST CONDITION	MIN.	TYP.	MAX.	UNITS
Forward Voltage	V_F	$I_F = 0.5\text{ A}, T_J = 25^\circ\text{C}$	-	0.75	-	V
		$I_F = 1\text{ A}, T_J = 25^\circ\text{C}$	-	-	0.85	V
		$I_F = 0.5\text{ A}, T_J = 125^\circ\text{C}$	-	0.6	-	V
		$I_F = 1\text{ A}, T_J = 125^\circ\text{C}$	-	0.67	-	V
Reverse Current ^(Note 3)	I_R	$V_R = 120\text{ V}, T_J = 25^\circ\text{C}$	-	0.15	-	uA
		$V_R = 150\text{ V}, T_J = 25^\circ\text{C}$	-	-	30	
		$V_R = 150\text{ V}, T_J = 125^\circ\text{C}$	-	110	-	

NOTES :

1. Mounted on a FR4 PCB, single-sided copper, standard footprint.
2. Mounted on a FR4 PCB, single-sided copper, with 100 cm² copper pad area.
3. Short duration pulse test used to minimize self-heating effect.



SS10150FL-AU

TYPICAL CHARACTERISTIC CURVES

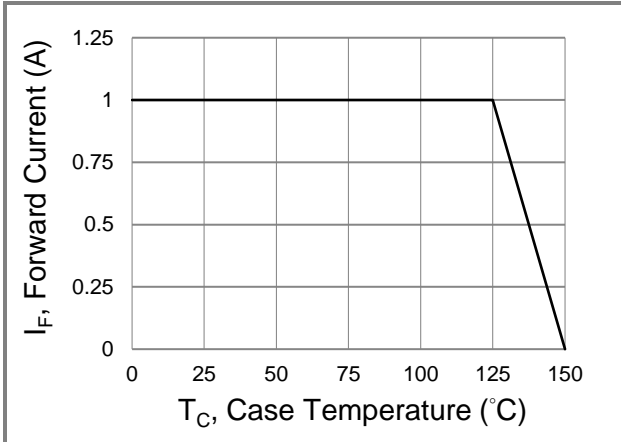

Fig.1 Forward Current Derating Curve

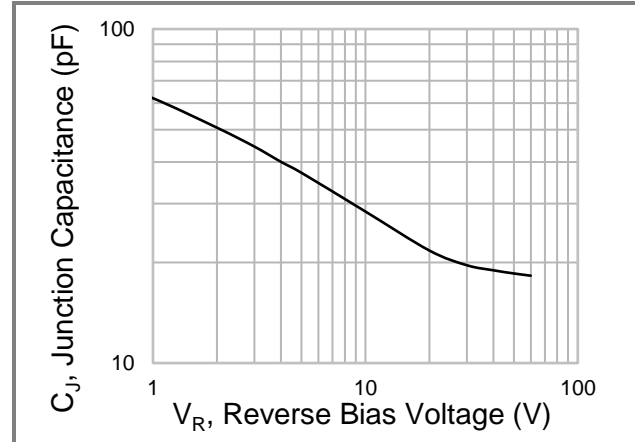

Fig.2 Typical Junction Capacitance

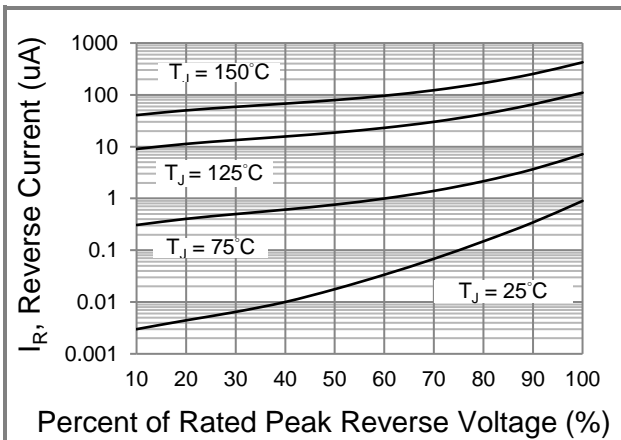

Fig.3 Typical Reverse Characteristics

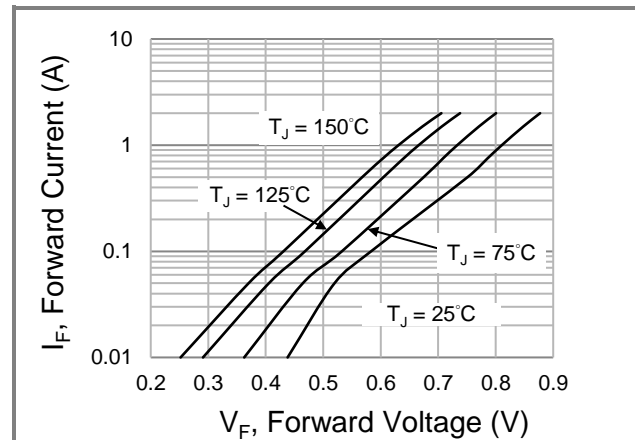

Fig.4 Typical Forward Characteristics

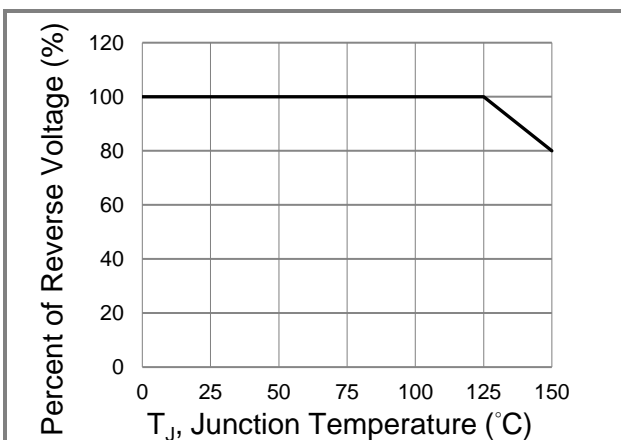

Fig.5 Operating Temperature Derating Curve



SS10150FL-AU

Part No. Packing Code Version

Part No.	Package Type	Packing Type	Marking	Version
SS10150FL-AU	SOD-123FL	3K pcs / 7" Reel	G15	Halogen free RoHS compliant

Packaging Information & Mounting Pad Layout

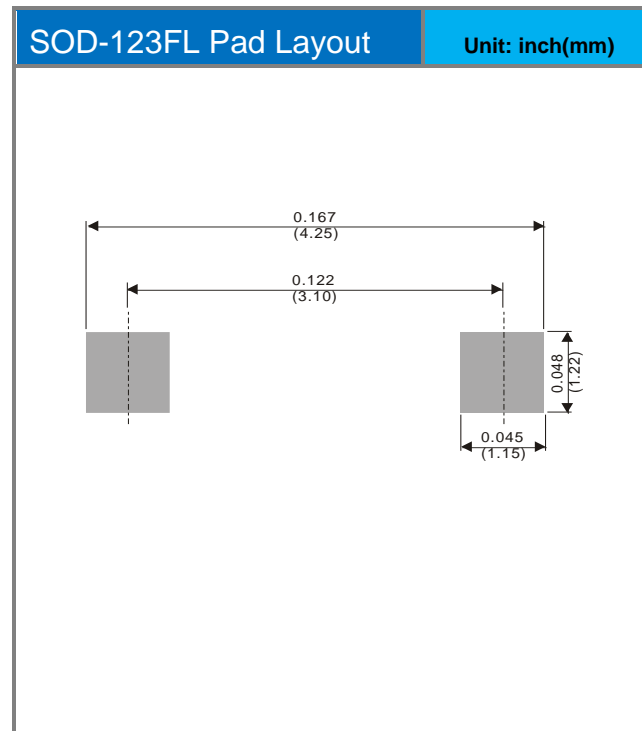
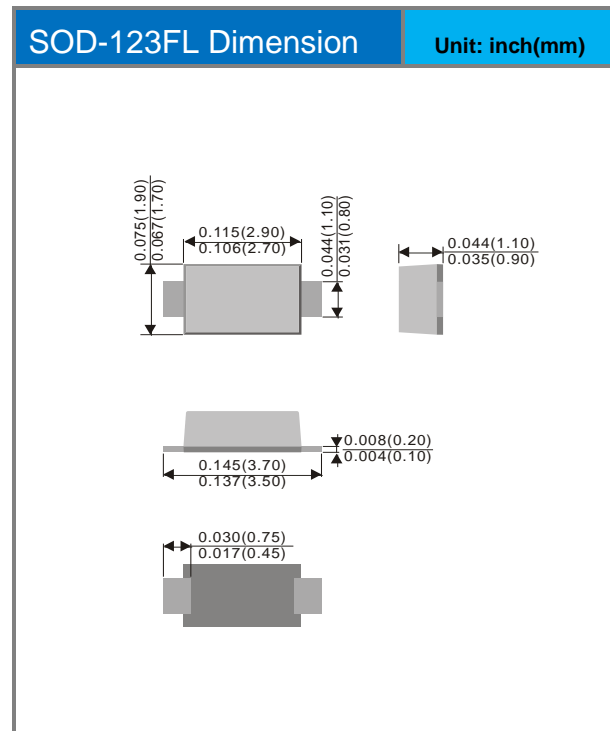



SS10150FL-AU

Disclaimer

- Reproducing and modifying information of the document is prohibited without permission from Panjit International Inc..
- Panjit International Inc. reserves the rights to make changes of the content herein the document anytime without notification. Please refer to our website for the latest document.
- Panjit International Inc. disclaims any and all liability arising out of the application or use of any product including damages incidentally and consequentially occurred.
- Panjit International Inc. does not assume any and all implied warranties, including warranties of fitness for particular purpose, non-infringement and merchantability.
- Applications shown on the herein document are examples of standard use and operation. Customers are responsible in comprehending the suitable use in particular applications. Panjit International Inc. makes no representation or warranty that such applications will be suitable for the specified use without further testing or modification.
- The products shown herein are not designed and authorized for equipments relating to human life and for any applications concerning life-saving or life-sustaining, such as medical instruments, aerospace machinery et cetera. Customers using or selling these products for use in such applications do so at their own risk and agree to fully indemnify Panjit International Inc. for any damages resulting from such improper use or sale.
- Since Panjit uses lot number as the tracking base, please provide the lot number for tracking when complaining.

Mouser Electronics

Authorized Distributor

Click to View Pricing, Inventory, Delivery & Lifecycle Information:

Panjit:

[SS10150FL-AU_R1_000A1](#)