

3 PORT AIR OPERATED VALVE SERIES SYJA300/500/700

- ✓ Compact design
- ✓ 3 body sizes available
- ✓ Interchangeable with older valve designs
- ✓ Standard type is copper free
- ✓ NO and NC types available

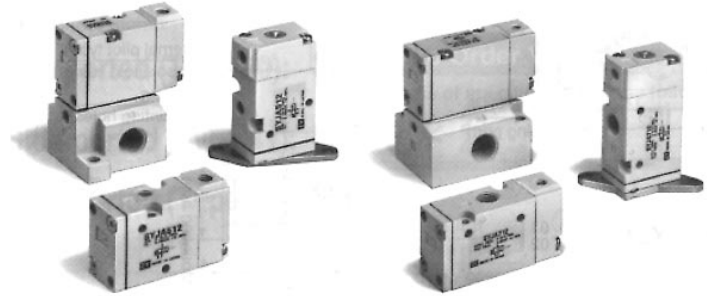

TECHNICAL SPECIFICATIONS

Type	SYJA300	SYJA500	SYJA700
Fluid	Air		
Operating pressure range	0.15-0.7MPa (1.5-7.1kgf/cm ²)		
Pilot pressure range	See chart below		
Ambient fluid temperature	Max 60°C		
Lubrication	Not required		
Mounting position	Free		
Pilot port size	M3	M5	M5
Cv (effective area mm ²)	0.05 (0.9)	0.2 (3.6)	0.5 (0.9)
Body port type			
Base mount type	0.1 (1.8)	0.25 (4.8)	0.5 (9.0)
Mass (g) Body only	18	45	80

PILOT PRESSURE RANGE

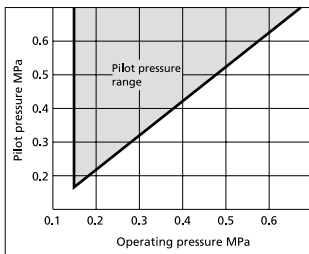

SYJA300

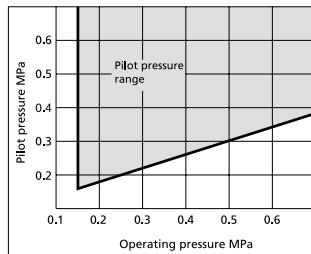

SYJA500 & 700

HOW TO ORDER

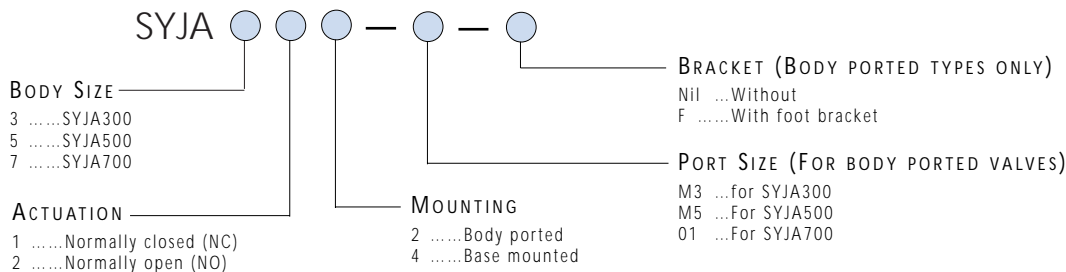

MANIFOLDS

Manifolds used for this series are common to the SYJ300/500/700 and details can be found in that section of the catalogue.

SYMBOLS

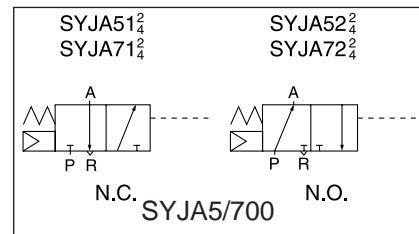
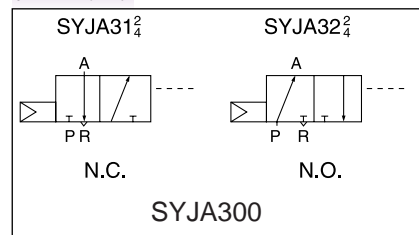

INTERCHANGEABILITY

The SYJA Series can be used in place of the valve bodies shown below

SYJA500 ↔ VZA300

SYJA700 ↔ VZA500

ACCESSORIES

SINGLE SUB BASES

For SYJA3*4	= SYJ300-9-1
For SYJA5*4	= SYJ500-9-1
For SYJA7*4	= SYJ700-9-1 (1/4" ported)
	SYJ700-9-2 (1/4" ported)



SEE INSIDE FRONT COVER FOR
DETAILS OF YOUR LOCAL SALES OFFICE



FOR FURTHER TECHNICAL
DETAILS ON THIS
PRODUCT REQUEST
CATALOGUE REFERENCE
E143-B

DIMENSIONS
SYJA300

Dimensions in mm

Body Ported Type : SYJA3□2-M3-(F)

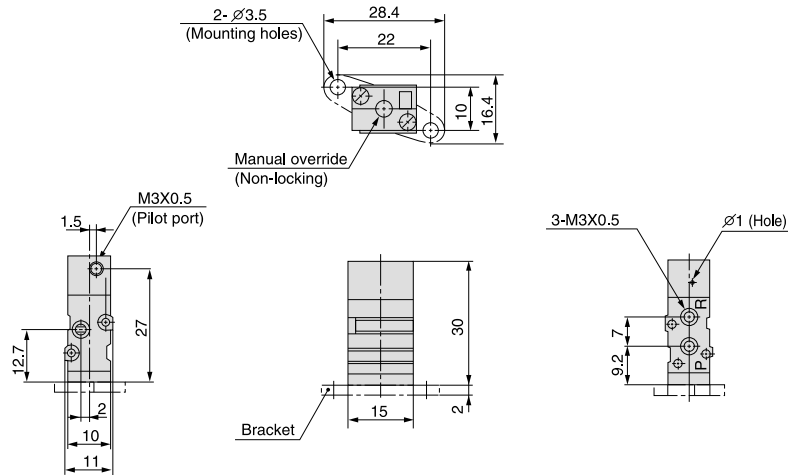

Base Mounted Type : SYJA3□4-M5

