



Surface Mount Terminal Blocks  
BTBH-H Series

---



# BTBH easy-stack

Easily assemble the required number of terminal blocks without tools



IDEC CORPORATION

# A new idea for surface mount terminal

## Finger-safe structure (IP20 protection)

IP20 finger-safe structure prevents direct contact to terminal parts without use of dust covers.

## Flexible assembly (no connecting rod required)

Reduced number of parts achieve an environmentally friendly product.

## Touchdown screw structure

The touchdown terminals with spring-loaded captive screws allow ring terminals or wire installation by lightly touching screw head. Reduces wiring time.

# blocks BTBH easy-stack™



## Marking

A marking area is available to affix labels directly on the terminal block.

## BTBH easy-stack terminal blocks

The required number of poles can be easily assembled without using special tools. Allows flexibility for specification changes or updates to maintenance work.

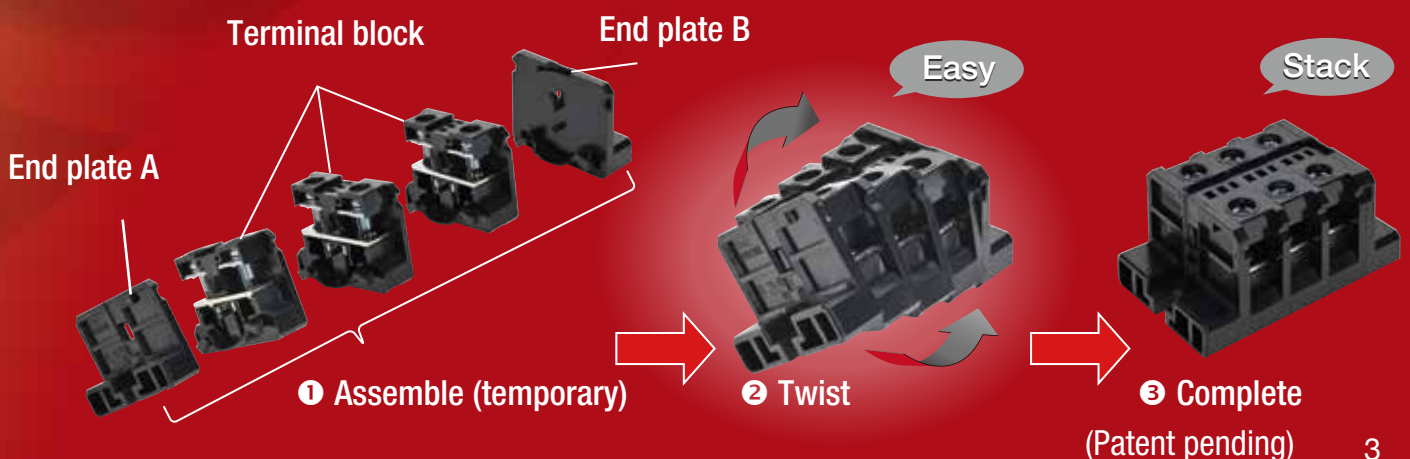

# Touchdown surface mount terminal blocks

**NEW**

## Ordering method 1: Components to be assembled

- Terminal blocks, end plates, and joint plates are available as components.
- Select and order the required component.
- The terminal blocks can easily assembled without using tools.
- Components can be added, replaced, and re-assembled due to specification changes or damages, as tools are not required.
- Inventory is reduced as assembled terminal blocks do not need to be stocked.



BTBH15-HPN  
BTBH15L-HPN  
BTBH30-HPN  
BTBH50-HPN

Package quantity: 50  
\*20 for BTBH50-HPN

Terminal block



End plate (both sides)

BTBHE15S-PN  
BTBHE30S-PN  
BTBHE50S-PN

Package quantity: 10 sets  
(10 each for right and left sides)



BTBHJ15PN

Package quantity: 5

Joint plate



Different terminal blocks can be combined and assembled

Terminal blocks with different current values can be combined, for example, when the wire diameters of the power and control systems are different. Suitable for space-saving solutions.

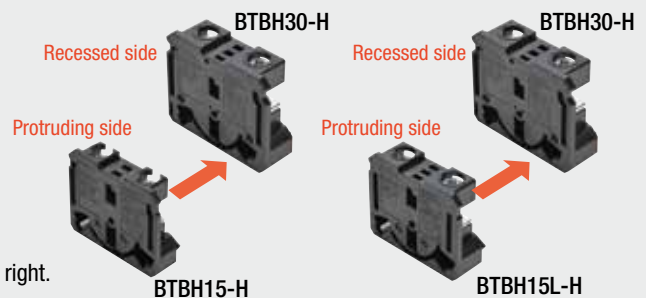

\*For mixed terminal block combinations, assemble as shown in the figure on the right.  
\*BTBH50-H cannot be combined with different size terminal blocks.

## Joint plates enable the mounting of any number of terminal blocks

By inserting a joint plate between terminal blocks, an unlimited number of poles can be assembled. The joint plate can be inserted in any position within the maximum number of poles that can be assembled.

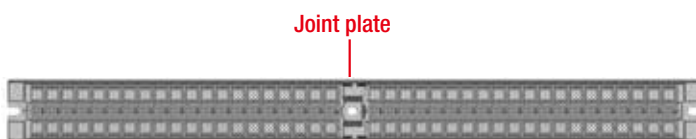

Joint plate

\*For details on the maximum number of poles, see instructions on page 15.  
\*A joint plate cannot be used for BTBH50-H.

## Optional accessories

Optional accessories available:

**Dust cover**  
Prevents dust from entering

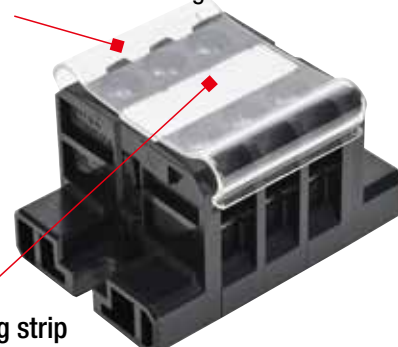

**Marking strip**  
Marking strips can be attached to the terminal block.

# BTBH-H SERIES

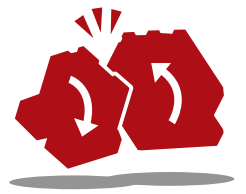

## Ordering method 2: BTBH-H Terminal blocks

- Assembled product with the requested number of poles.
- Terminal block components can be added in the field to increase (or decrease) the number of poles for the application.

### BTBH15-H□

2 to 30 poles



- Terminal shape: M3 screw
- Number of poles: 2 to 30  
(A joint plate is supplied 21 to 30 poles)
- Applicable wires: 1.25mm<sup>2</sup> (22-14AWG)
- UL/CSA ratings: 600V/10A

### BTBH15L-H□

2 to 30 poles



- Terminal shape: M3.5 screw
- Number of poles: 2 to 30  
(A joint plate is supplied for 21 to 30 poles)
- Applicable wires: 2mm<sup>2</sup> (22-14AWG)
- UL/CSA ratings: 600V/15A

### BTBH30-H□

2 to 30 poles



- Terminal shape: M4 screw
- Number of poles: 2 to 30  
(A joint plate is supplied for 16 to 30 poles)
- Applicable wires: 5.5mm<sup>2</sup> (18 to 10AWG)
- UL/CSA ratings: 600V/30A

### BTBH50-H□

2 to 15 poles



- Terminal shape: M5 screw
- Number of poles: 2 to 15
- Applicable wires: 14mm<sup>2</sup> (16 to 6AWG)
- UL/CSA ratings: 600V/50A

## Suitable for installation in limited spaces

The installation height is up to 7mm less than rail mount terminal blocks, allowing installation in limited spaces.

Installation height  
7mm less



BNH series  
Rail mount terminal blocks

BTBH-H series  
Surface mount terminal blocks

\*Compared with IDEC rail mount terminal blocks BNH15MW, BNH15LW, BNH30W, and BNH50W.

\*Compared with the height when the terminal block is mounted on a DIN rail (BAA100).

## Environmentally friendly products

Reduced number of parts (dust cover, marking strips, connecting shaft, screws) contribute to environmental protection.

### Evaluation items for environmentally friendly products

- Resource saving
- Lightweight
- Reduced number of parts
- Reduced man hours
- Easy to disassemble



# BTBH-H Series Surface Mount Terminal Blocks

- Easy-to assemble touchdown structure surface-mount terminal blocks.
- Touch-down terminal block with IP20 finger protection.
- Highly flame-resistant UL certified resin (UL94V-0).
- Complies with JIS C 8201-7-1 and NECA C 2811.
- UL, CSA certified. EN compliant (TÜV certified)
- UL standard factory wiring and field wiring (FW2).



• See website for details on approvals and standards.



## Common specifications

Withstand voltage	2500V AC, 1 minute
Insulation resistance	100MΩ minimum
Operating temperature	-25 to +55°C (no freezing)
Storage temperature	-25 to +70°C (no freezing)
Relative humidity	45 to 85%RH (no condensation)
Degree of protection	IP20 (IEC60529)

## Parts material

Part Name	Material (Treatment)
Terminal block, end plate, Joint plate	Modified PPE resin
Bus bars	Brass (nickel plated)
Terminal screw	Steel (zinc plated trivalent chromate)

## Ratings / Terminal screw tightening torque

Series	Name	Terminal screw	UL/CSA		EN		JIS		Recommended tightening torque (N·m)	
			Ratings	Applicable wire: AWG	Ratings	Applicable wire: mm <sup>2</sup> (AWG)	Ratings	Applicable wire: mm <sup>2</sup>		
BTBH-H	Touch-down	BTBH15-H	M3	600V/10A	22-14	800V/22A	2 (18-14)	800V/16A	1.25 (2) (*1)	0.6 to 1.0
		BTBH15L-H	M3.5	600V/15A	22-14	800V/22A	2 (18-14)	800V/21A	2	1.0 to 1.3
		BTBH30-H	M4	600V/30A	18-10	800V/38A	5.5 (14-10)	800V/40A	5.5	1.4 to 2.0
		BTBH50-H	M5	600V/50A	16-6	800V/67A	1 (10-6)	800V/70A	14	2.6 to 3.7

\*1) The applicable wire is 1.25mm<sup>2</sup>, but 2mm<sup>2</sup> wires can be connected.

- The current draw depends on the conditions of use. See "Selecting Terminal Blocks by Current According to JIS Standards" on pages 17 and 18.
- Dust covers, marking strips, and jumpers are not supplied with the terminal block. Order separately. (See pages 13 and 14)

BTBH15-H

16A

### When ordering an assembled product

Name	No. of Poles	Part No.	Package quantity	No. of Poles	Part No.	Package quantity
BTBH15-H (Touch-down) 	2	BTBH15-H2	1	16	BTBH15-H16	1
	3	BTBH15-H3	1	17	BTBH15-H17	1
	4	BTBH15-H4	1	18	BTBH15-H18	1
	5	BTBH15-H5	1	19	BTBH15-H19	1
	6	BTBH15-H6	1	20	BTBH15-H20	1
	7	BTBH15-H7	1	21	BTBH15-H21	1
	8	BTBH15-H8	1	22	BTBH15-H22	1
	9	BTBH15-H9	1	23	BTBH15-H23	1
	10	BTBH15-H10	1	24	BTBH15-H24	1
	11	BTBH15-H11	1	25	BTBH15-H25	1
	12	BTBH15-H12	1	26	BTBH15-H26	1
	13	BTBH15-H13	1	27	BTBH15-H27	1
	14	BTBH15-H14	1	28	BTBH15-H28	1
	15	BTBH15-H15	1	29	BTBH15-H29	1
					30	BTBH15-H30

- Dust covers and marking strips are not supplied.
- See page 11 for dimensions.
- Terminal blocks with 21 poles or more come with a joint plate.

### When ordering by components

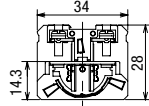
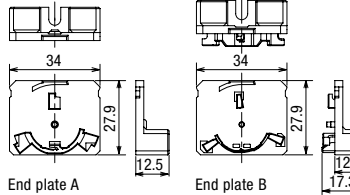
Name	No. of Poles	Part No.	Package quantity	Dimensions (mm)	
BTBH15-H (Touch-down)	Terminal block	1	BTBH15-HPN	50	
	End plate (both ends)	-	BTBHE15S-PN	10 (10 each of left and right end plates)	
	Joint plate	-	BTBHJ15PN	5	See page 13

- Dust covers and marking strips are not supplied.
- End plates are not supplied with the terminal block. Order separately.
- Joint plates are not supplied with the terminal block. Joint plates are required when connecting 21 poles or more of BTBH15-HPN or combining a total of 16 poles or more of BTBH15-HPN with BTBH15L-HPN or BTBH30-HPN.
- For details on the maximum number of poles, see page 15.

### Specifications

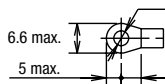
		BTBH15-H		
Standards		UL/CSA	EN	JIS
Ratings / Specifications	Rated insulation voltage	600V	800V	800V
	Applicable wire size	22-14AWG	2mm <sup>2</sup> (18-14AWG)	1.25mm <sup>2</sup> (2mm <sup>2</sup> ) (*1)
	Rated current	10A	22A	16A
	Terminal screw	M3		
	Applicable crimping terminal	1.25-3 (2-3)		
	Maximum number of crimping terminals	2		
Recommended tightening torque		0.6 to 1.0N·m		
Applicable crimping terminal dimensions (mm)				
Accessories See page 13 to 14.	Dust cover	BNC220		
	Marking strip	Vinyl Chloride 1m/BNM7, Fiber Sheet 1m/BNM9, Vinyl Chloride 25m/BNM725, BNM725-TK1700		
	Jumper	BNJ36, BNJ36B, BNJ36F, BNJ36FB		

\*1) Applicable wire is 1.25mm<sup>2</sup>, but 2mm<sup>2</sup>wires can be connected.

When ordering an assembled product

Name	No. of Poles	Part No.	Package quantity	No. of Poles	Part No.	Package quantity
BTBH15L-H (Touch-down) 	2	BTBH15L-H2	1	16	BTBH15L-H16	1
	3	BTBH15L-H3	1	17	BTBH15L-H17	1
	4	BTBH15L-H4	1	18	BTBH15L-H18	1
	5	BTBH15L-H5	1	19	BTBH15L-H19	1
	6	BTBH15L-H6	1	20	BTBH15L-H20	1
	7	BTBH15L-H7	1	21	BTBH15L-H21	1
	8	BTBH15L-H8	1	22	BTBH15L-H22	1
	9	BTBH15L-H9	1	23	BTBH15L-H23	1
	10	BTBH15L-H10	1	24	BTBH15L-H24	1
	11	BTBH15L-H11	1	25	BTBH15L-H25	1
	12	BTBH15L-H12	1	26	BTBH15L-H26	1
	13	BTBH15L-H13	1	27	BTBH15L-H27	1
	14	BTBH15L-H14	1	28	BTBH15L-H28	1
	15	BTBH15L-H15	1	29	BTBH15L-H29	1
					30	BTBH15L-H30

- Dust covers and marking strips are not supplied.
- See page 12 for dimensions.
- Terminal blocks with 21 poles or more come with a joint plate.

When ordering by components

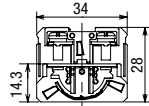
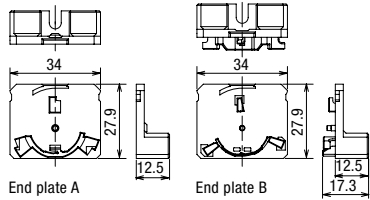
Name	No. of Poles	Part No.	Package quantity	Dimensions (mm.)	
BTBH15L-H (Touch-down)	Terminal block	1	BTBH15L-HPN	50	
	End plate (both ends)	-	BTBHE15S-PN	10 (10 each of left and right end plates)	
	Joint plate	-	BTBHJ15PN	5	See page 8.

- Dust covers and marking strips are not supplied.
- End plates are not supplied with the terminal block. Order separately.
- Joint plates are not supplied with the terminal block. Joint plates are required when connecting 21 poles or more of BTBH15L-HPN or combining a total of 16 or more of BTBH15L-HPN with BTBH15-HPN or BTBH30-HPN.
- For details on the maximum number of poles, see page 15.

Specifications

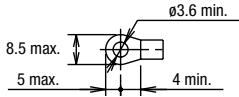
		BTBH15L-H		
Standards		UL/CSA	EN	JIS
Ratings / Specifications	Rated insulation voltage	600V	800V	800V
	Applicable wire size	22-14AWG	2mm <sup>2</sup> (18-14AWG)	1.25mm <sup>2</sup> (2mm <sup>2</sup> )(*1)
	Rated current	15A	22A	16A
	Terminal screw	M3.5		
	Applicable crimping terminal	2-3.5		
	Maximum number of crimping terminals	2		
Recommended tightening torque		1.0 to 1.3N·m		
Applicable crimping terminal dimensions (mm)				
Accessories See page 13 to 14.	Dust cover	BNC220		
	Marking strip	Vinyl Chloride 1m/BNM7, Fiber Sheet 1m/BNM9, Vinyl Chloride 25m/BNM725, BNM725-TK1700		
	Jumpers	BNJ46, BNJ46B, BNJ46F, BNJ46FB		



BTBH30-H

40A

### When ordering an assembled product

Name	No. of Poles	Part No.	Package quantity	No. of Poles	Part No.	Package quantity
BTBH30-H (Touch-down) 	2	BTBH30-H2	1	16	BTBH30-H16	1
	3	BTBH30-H3	1	17	BTBH30-H17	1
	4	BTBH30-H4	1	18	BTBH30-H18	1
	5	BTBH30-H5	1	19	BTBH30-H19	1
	6	BTBH30-H6	1	20	BTBH30-H20	1
	7	BTBH30-H7	1	21	BTBH30-H21	1
	8	BTBH30-H8	1	22	BTBH30-H22	1
	9	BTBH30-H9	1	23	BTBH30-H23	1
	10	BTBH30-H10	1	24	BTBH30-H24	1
	11	BTBH30-H11	1	25	BTBH30-H25	1
	12	BTBH30-H12	1	26	BTBH30-H26	1
	13	BTBH30-H13	1	27	BTBH30-H27	1
	14	BTBH30-H14	1	28	BTBH30-H28	1
	15	BTBH30-H15	1	29	BTBH30-H29	1
					30	BTBH30-H30

- Dust covers and marking strips are not supplied.
- See page 7 for dimensions.
- Terminal blocks with 21 poles or more come with a joint plate.

### When ordering by components

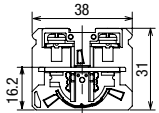
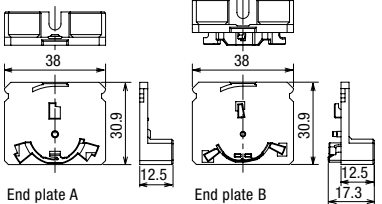
Name	No. of Poles	Part No.	Package quantity	Dimensions (mm)	
BTBH30-H (Touch-down)	Terminal block	1	BTBH30-HPN	50	
	End plate (both ends)	-	BTBHE30S-PN	10 (10 each of left and right end plates)	 End plate A      End plate B
	Joint plate	-	BTBHJ15PN	5	See page 8.

- Dust covers and marking strips are not supplied.
- End plates are not supplied with the terminal block. Order separately.
- Joint plates are not supplied with the terminal block. Joint plates are required when connecting 21 poles or more of BTBH30-HPN or combining a total of 16 or more of BTBH30-HPN with BTBH15-HPN or BTBH15L-HPN.
- For details on the maximum number of poles, see page 10.

### Specifications

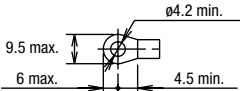
		BTBH30-H		
Standards		UL/CSA	EN	JIS
Ratings / Specifications	Rated insulation voltage	600V	800V	800V
	Applicable wire size	18-10AWG	5.5mm <sup>2</sup> (14-10AWG)	5.5mm <sup>2</sup>
	Rated current	30A	38A	40A
	Terminal screw	M4		
	Applicable crimping terminal	1.25-4 to 5.5-4		
	Maximum number of crimping terminals	2		
Recommended tightening torque		1.4 to 2.0N·m		
Applicable crimping terminal dimensions (mm)				
Accessories See page 13 to 14.	Dust cover	BNC230		
	Marking strip	Vinyl Chloride 1m/BNM7, Fiber Sheet 1m/BNM9, Vinyl Chloride 25m/BNM725, BNM725-TK1700		
	Jumper	BNJ56, BNJ56B, BNJ56F, BNJ56FB		

When ordering an assembled product

Name	No. of Poles	Part No.	Package quantity
BTBH50-H (Touch-down) 	2	BTBH50-H2	1
	3	BTBH50-H3	1
	4	BTBH50-H4	1
	5	BTBH50-H5	1
	6	BTBH50-H6	1
	7	BTBH50-H7	1
	8	BTBH50-H8	1
	9	BTBH50-H9	1
	10	BTBH50-H10	1
	11	BTBH50-H11	1
	12	BTBH50-H12	1
	13	BTBH50-H13	1
	14	BTBH50-H14	1
	15	BTBH50-H15	1

- Dust covers and marking strips are not supplied.
- See page 7 for dimensions.
- Terminal blocks with 16 poles or more come with a joint plate.

When ordering by components

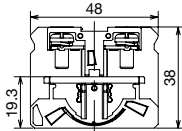
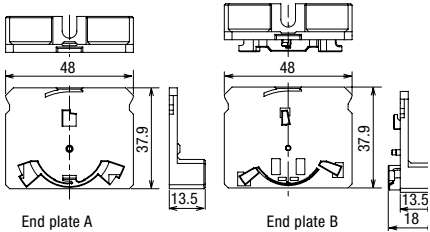
Name	No. of Poles	Part No.	Package quantity	Dimensions (mm)	
BTBH50-H (Touch-down)	Terminal block	1	BTBH50-HPN	20	
	End plate (both ends)	-	BTBHE50S-PN	10 (10 each of left and right end plates)	

- Dust covers and marking strips are not supplied.
- End plates are not supplied with the terminal block. Order separately.
- For details on the maximum number of poles, see page 15.

Specifications

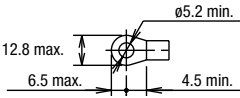
		BTBH50-H		
Standards		UL/CSA	EN	JIS
Ratings / Specifications	Rated insulation voltage	600V	800V	800V
	Applicable wire size	16-6AWG	14mm <sup>2</sup> (10-6AWG)	14mm <sup>2</sup>
	Rated current	50A	67A	70A
	Terminal screw	M5		
	Applicable crimping terminal	1.25-5 to 14-5		
	Maximum number of crimping terminals	2		
Recommended tightening torque		2.6 to 3.7N·m		
Applicable crimping terminal dimensions (mm)				
Accessories See page 13 to 14.	Dust cover	BNC320		
	Marking strip	Vinyl Chloride 1m/BNM7, Fiber Sheet 1m/BNM9, Vinyl Chloride 25m/BNM725, BNM725-TK1700		
	Jumper	BNJ62, BNJ62B		

Dimensions

All dimensions in mm.

BTBH15-H□ (terminal centers: 8.5mm)

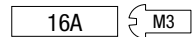

2 to 20 poles

21 to 30 poles (with joint plate)

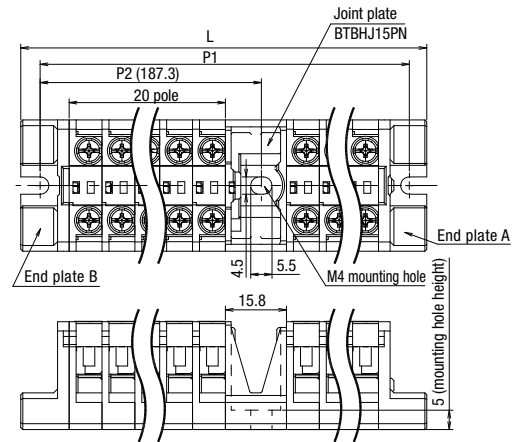
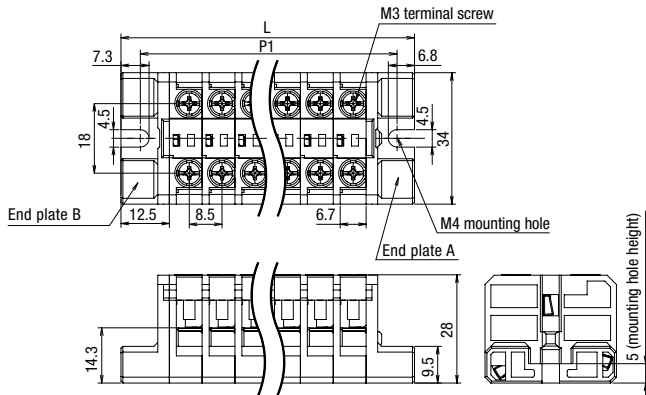

L, P Dimensions (mm)

No. of Poles	2	3	4	5	6	7	8	9	10	11	12	13	14	15	16	17	18	19	20
L	42	50.5	59	67.5	76	84.5	93	101.5	110	118.5	127	135.5	144	152.5	161	169.5	178	186.5	195
P1	33	41.5	50	58.5	67	75.5	84	92.5	101	109.5	118	126.5	135	143.5	152	160.5	169	177.5	186

No. of Poles	21	22	23	24	25	26	27	28	29	30
L	219.3	227.8	236.3	244.8	253.3	261.8	270.3	278.8	287.3	295.8
P1	210.3	218.8	227.3	235.8	244.3	252.8	261.3	269.8	278.3	286.8
P2	187.3	187.3	187.3	187.3	187.3	187.3	187.3	187.3	187.3	187.3

Weight calculation (Unit: g)  
 $7.5 \times n + 7.5 + 5.2 \times m$   
 n: Number of terminal blocks  
 m: Number of joint plates

- Weight (per pole) Terminal block: approx. 7.5g, End plate (both ends): approx. 7.5g, Joint plate: approx. 5.2g
- L (terminal block length) and P (mounting centers) dimensions are the standard dimensions of each terminal block.
- A slight dimensional difference may occur when many terminal blocks are assembled.

BTBH15L-H□ (terminal centers: 10.5mm)



2 to 20 poles

21 to 30 poles (with joint plate)

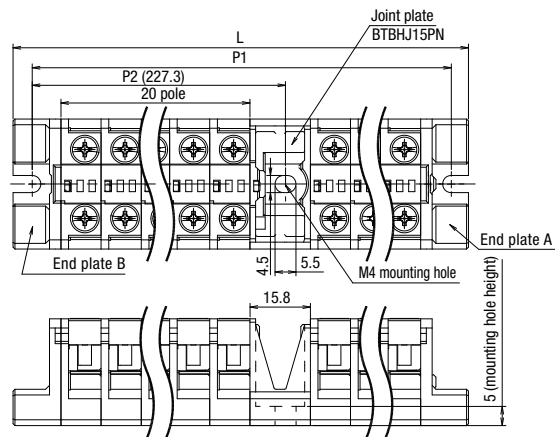
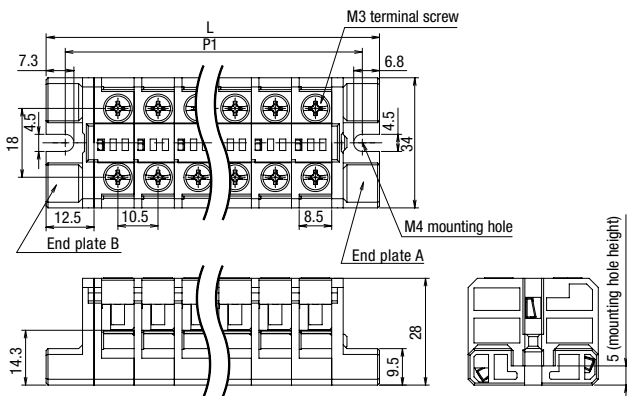

L, P Dimensions (mm)

No. of Poles	2	3	4	5	6	7	8	9	10	11	12	13	14	15	16	17	18	19	20
L	46	56.5	67	77.5	88	98.5	109	119.5	130	140.5	151	161.5	172	182.5	193	203.5	214	224.5	235
P1	37	47.5	58	68.5	79	89.5	100	110.5	121	131.5	142	152.5	163	173.5	184	194.5	205	215.5	226

No. of Poles	21	22	23	24	25	26	27	28	29	30
L	261.3	271.8	282.3	292.8	303.3	313.8	324.3	334.8	345.3	355.8
P1	252.3	262.8	273.3	283.8	294.3	304.8	315.3	325.8	336.3	346.8
P2	227.3	227.3	227.3	227.3	227.3	227.3	227.3	227.3	227.3	227.3

Weight calculation (Unit: g)  
 $9.8 \times n + 7.5 + 5.2 \times m$   
 n: Number of terminal blocks  
 m: Number of joint plates

- Weight (per pole) Terminal block: approx. 9.8g, End plate(both ends): approx. 7.5g, Joint plate: approx. 5.2g
- L (terminal block length) and P (mounting centers) dimensions are the standard dimensions of each terminal block.
- A slight dimensional difference may occur when many terminal blocks are assembled.

Dimensions

All dimensions in mm.

BTBH30-H□ (terminal centers: 12mm)



2 to 15 poles

16 to 30 poles (with joint plate)

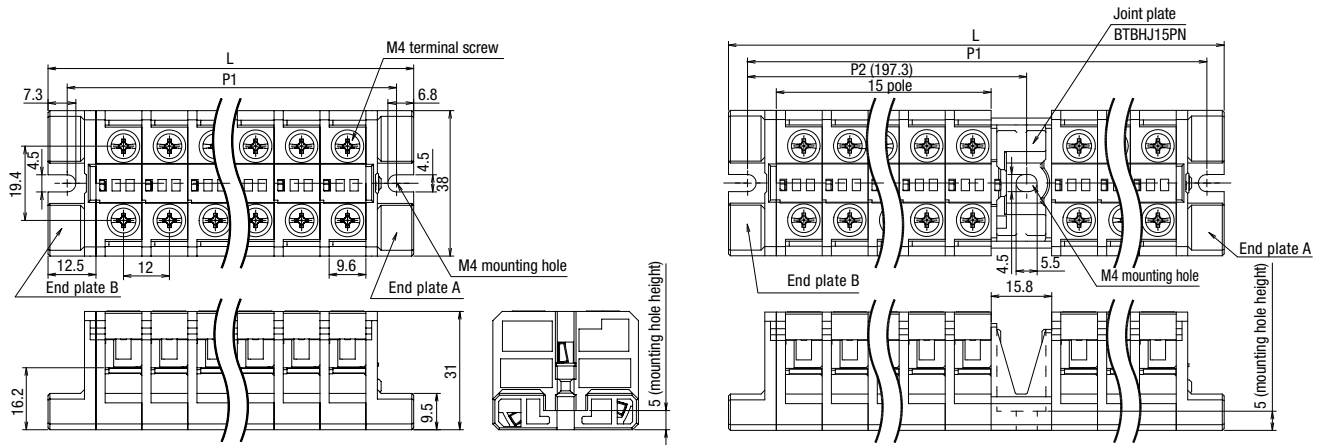

L, P Dimensions (mm)

No. of Poles	2	3	4	5	6	7	8	9	10	11	12	13	14	15
L	49	61	73	85	97	109	121	133	145	157	169	181	193	205
P1	40	52	64	76	88	100	112	124	136	148	160	172	184	196

No. of Poles	16	17	18	19	20	21	22	23	24	25	26	27	28	29	30
L	232.8	244.8	256.8	268.8	280.8	292.8	304.8	316.8	328.8	340.8	352.8	364.8	376.8	388.8	400.8
P1	223.8	235.8	247.8	259.8	271.8	283.8	295.8	307.8	319.8	331.8	343.8	355.8	367.8	379.8	391.8
P2	197.3	197.3	197.3	197.3	197.3	197.3	197.3	197.3	197.3	197.3	197.3	197.3	197.3	197.3	197.3

Weight calculation (Unit: g)  
 $14 \times n + 9 + 5.2 \times m$   
 n: Number of terminal blocks  
 m: Number of joint plates

- Weight (per pole) ... Terminal block body: approx. 14g, End plate(both ends): approx. 9g, Joint plate: approx. 5.2g
- L (body length) and P (mounting hole pitch) dimensions are the standard dimensions for each terminal block.
- Because of the coupling method, a slight dimensional error may occur when the number of poles is increased.

BTBH50-H□ (terminal centers: 15.5mm)

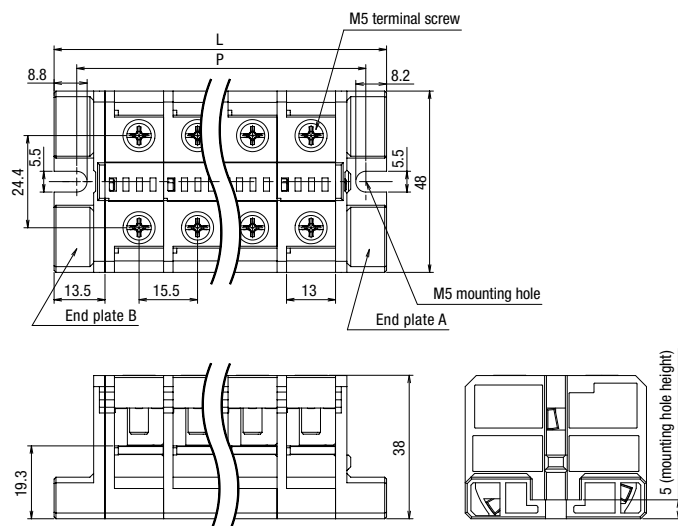
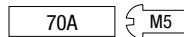

L, P Dimensions (mm)

No. of Poles	2	3	4	5	6	7	8	9	10	11	12	13	14	15
L	58	73.5	89	104.5	120	135.5	151	166.5	182	197.5	213	228.5	244	259.5
p	47	62.5	78	93.5	109	124.5	140	155.5	171	186.5	202	217.5	233	248.5

Weight calculation (Unit: g)  
 $26.1 \times n + 12.9$   
 n: Number of terminal blocks

- Weight (per pole) ... Terminal block: approx. 26.1g, End plate (both ends): approx. 12.9g
- L (terminal block length) and P (mounting centers) dimensions are the standard dimensions of each terminal block.
- A slight dimensional difference may occur when many terminal blocks are assembled.

Accessories and Maintenance Parts

(All dimensions in mm.)

Dust covers and marking strips are not supplied with the assembled product.

**End Plate** (Supplied with the assembled product. When ordering as a component, order the required quantity separately from the terminal block)

Name	Part No.	Applicable terminal block	Package quantity	Weight (approx.)
End plates (both ends)	BTBHE15S-PN	BTBH15-H/BTBH15L-H	10 (10 each of left and right parts)	7.5g
	BTBHE30S-PN	BTBH30-H		9g
	BTBHE50S-PN	BTBH50-H		12.9g

**Joint plate** (Supplied with some assembled products. When ordering as a component, order the required quantity separately from the terminal block)

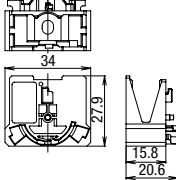
Name	Part No.	Dimensions	Applicable terminal block	Package quantity	Weight (approx.)
Joint plate	BTBHJ15PN		BTBH15-H BTBH15L-H/BTBH30-H	5	5.2g

• Not available for BTBH50-H.

**Jumper for 6-pole** (\*1) (Material: brass Surface treatment: nickel-plated Coating (\*2): vinyl chloride)

When ordering, specify the Ordering No.

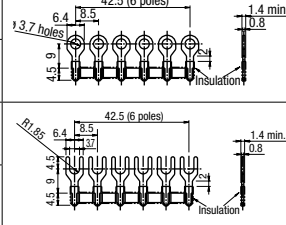
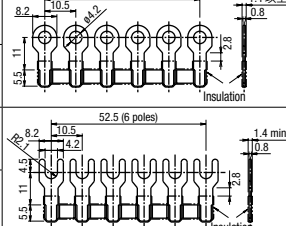
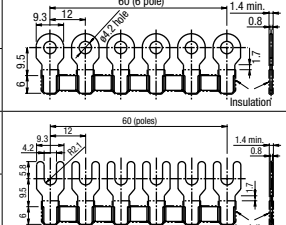
Terminal center	Insulation	Part No.	Ordering No.	Dimensions	Max. Current (*3)	Applicable terminal block	Package quantity	Weight (approx.)	
8.5mm	Ring terminal	Without	BNJ36	BNJ36PN10		20A	BTBH15-H	10	2.8g
		With	BNJ36B	BNJ36BPN10					3.4g
	Fork terminal	Without	BNJ36F	BNJ36FPN10					2.8g
		With	BNJ36FB	BNJ36FBPN10					3.3g
10.5mm	Ring terminal	Without	BNJ46	BNJ46PN10		20A	BTBH15L-H	10	5g
		With	BNJ46B	BNJ46BPN10					5.7g
	Fork terminal	Without	BNJ46F	BNJ46FPN10					4.7g
		With	BNJ46FB	BNJ46FBPN10					5.6g
12mm	Ring terminal	Without	BNJ56	BNJ56PN10		30A	BTBH30-H	10	6g
		With	BNJ56B	BNJ56BPN10					6.9g
	Fork terminal	Without	BNJ56F	BNJ56FPN10					5.9g
		With	BNJ56FB	BNJ56FBPN10					7.2g

\*1) No more than 6 poles. \*2) Insulation color: Black \*3) Ensure that the total current to the jumper does not exceed the maximum current.

**Jumper for 2-poles** (Material: brass Surface treatment: nickel plating Coating: vinyl chloride (black))

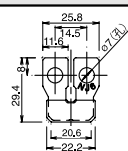
Terminal center	Insulation	Part No.	Ordering No.	Dimensions	Max. Current (*4) (*5)	Applicable terminal block	Package quantity	Weight (approx.)	
14.5mm	Ring terminal	Without	BNJ62	BNJ62PN10		80A	BTBH50-H	10	8.8g
		With	BNJ62B	BNJ62BPN10					9.5g

\*4) Ensure that the total current to the jumper does not exceed the maximum current.

\*5) Make sure not to exceed the rated current of the applicable terminal block.

**Marking strip** (Not supplied with the assembled product. Order separately.) Applicable terminal blocks: All BTBH-H series terminal blocks When ordering, specify the Ordering No.

Part No.	Ordering No.	Material / Size	Package quantity
BNM7	BNM7PN10	Vinyl chloride (surface: smooth) Length 1000mm × Width 9.5mm × 0.5mm	10
BNM9	BNM9PN10	Fiber sheet (surface: rough) Length 1000mm × Width 9.5mm × 0.5mm	10
BNM725-TK1700	BNM725-TK1700	Vinyl chloride (surface: smooth) Length 25m × Width 9.5mm × 0.5mm	1
BNM725	BNM725	Vinyl chloride (surface: rough) Length 25m × Width 9.5mm × 0.5mm	1

• BNM7, BNM725-TK1700 (slick surface) recommended when printing using printers.

## Accessories and Maintenance Parts

**Dust cover** (not supplied with the assembled product. Order separately.)

When ordering, specify the Ordering No.

Applicable terminal block	Ordering No.	Material / Length	Package quantity	Weight (approx.)
BTBH15-H BTBH15L-H	BNC220PN10	Polycarbonate resin, 1000mm	10	53g
BTBH30-H	BNC230PN10	Polycarbonate resin, 1000mm	10	68g
BTBH50-H	BNC320PN10	Polycarbonate resin, 1000mm	10	87g

- For dust-proof measures.

## Instructions

### Notes on Wiring

#### Crimping terminals

When using crimping terminals, be sure to use insulated terminals.

#### Direct wiring

Wire stripping lengths are as follows:

BTBH15-H	8.3mm
BTBH15L-H	9mm
BTBH30-H	10mm
BTBH50-H	12mm

Insert the wire until the insulation comes into contact with the terminal metal part.

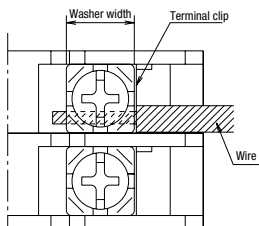

When connecting two wires, use wires of the same size.

#### How to install a fixed terminal block

Use the mounting screws below.

Name	Mounting screw	Tightening torque (N·m)
BTBH15-H	M4 screw + M4 flat washer (small) or M4 screw + M4 plain washer (small) + M4 spring washer (No.2)	1.0 to 1.2
BTBH15L-H		
BTBH30-H		
BTBH50-H	M5 screw + M5 flat washer (small) or M5 screw + M5 plain washer (small) + M5 spring washer (No.2)	

The mounting point is the mounting hole. See pages 11 and 12.

When using a joint plate, be sure to use mounting screws.

Plain washers must be used. Otherwise, damages may be caused.

### Assembly of Components

When ordering by components, the terminal blocks can be assembled without tools.

- ① Assemble the recessed and protruded sides of the terminal blocks and temporarily install the end plate A (recessed side) and end plate B (protruded side) by installing them to both ends of the terminal block.
- ② The terminal block can be assembled by temporarily assembling each component, and then by twisting the terminal block.

- Do not apply excessive force after it is assembled. Otherwise, it may damage the product.
- To disassemble, twist in the opposite direction of when it was assembled.

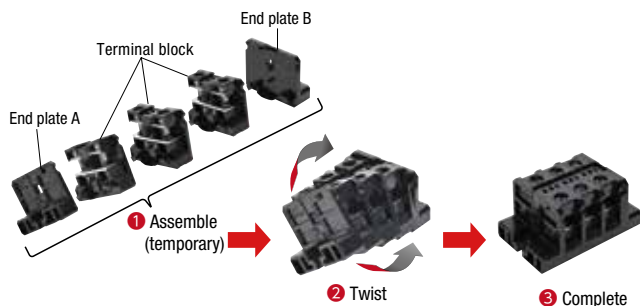

Instructions

- BTBH15/15L/30-H can be assembled with different model terminal blocks. When using different terminal blocks, be sure to assemble as shown in the table below. If the terminal blocks are assembled incorrectly, insulation features will be impaired. However, BTBH50-H cannot be assembled different model terminal blocks. When assembling BTBH15/15L/30-H terminal blocks, both BTBHE15S and BTBHE30S end plates can be used.

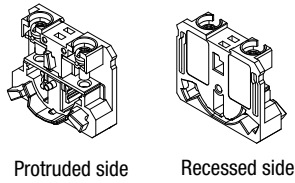

Protruded side of terminal block	Recessed side of the terminal block			
	BTBH15-H	BTBH15L-H	BTBH30-H	BTBH50-H
BTBH15-H	✓	✓	✓	×
BTBH15L-H	×	✓	✓	×
BTBH30-H	×	×	✓	×
BTBH50-H	×	×	×	✓

Correct

Incorrect

(Example 1) BTBH15-H and BTBH15L-H assembly

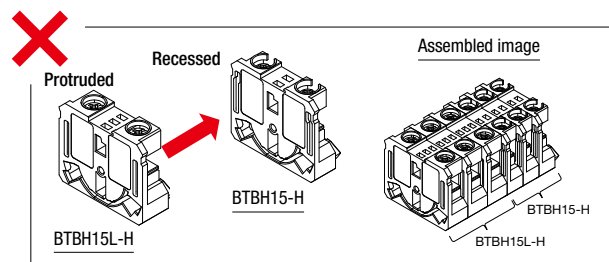
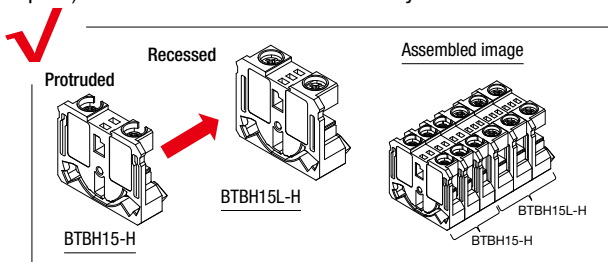

(Example 2) BTBH15-H and BTBH30-H assembly

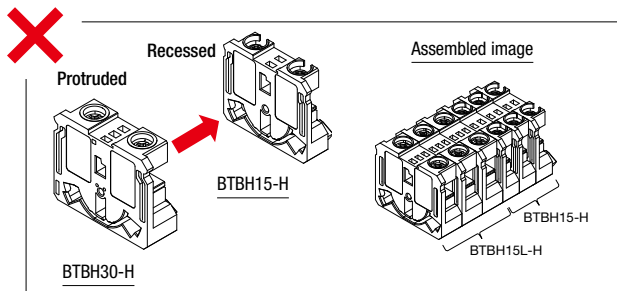
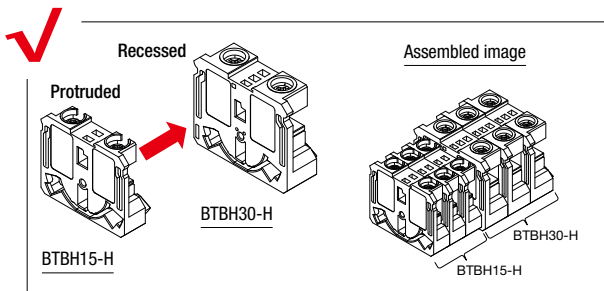

(Example 3) BTBH15L-H and BTBH30-H assembly

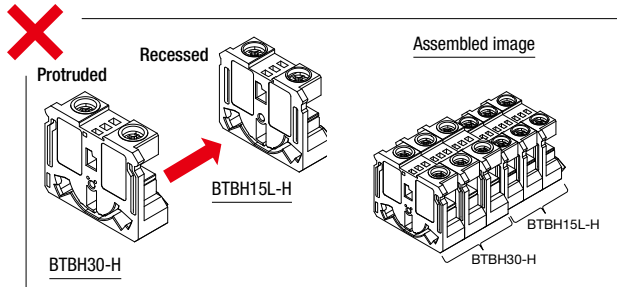
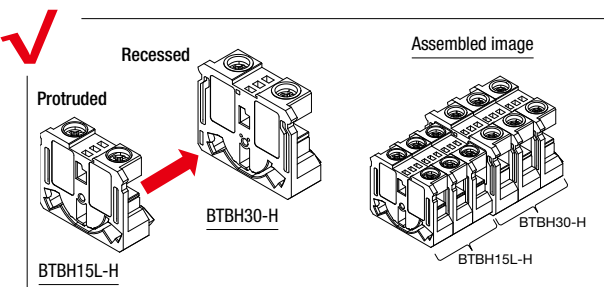

- The maximum number of poles that can be assembled is shown in the table below. If more than the maximum number of poles are connected, the connecting part may be damaged if shock is applied. BTBH50-H cannot be used in mounting direction ④.

	Mounting direction ① ② ③	Mounting direction ④
BTBH15-H	20 poles	6 poles
BTBH15L-H	20 poles	6 poles
BTBH30-H	15 poles	6 poles
BTBH50-H	15 poles	N/A
BTBH15/15L/30-H (combined)	15 poles	6 poles

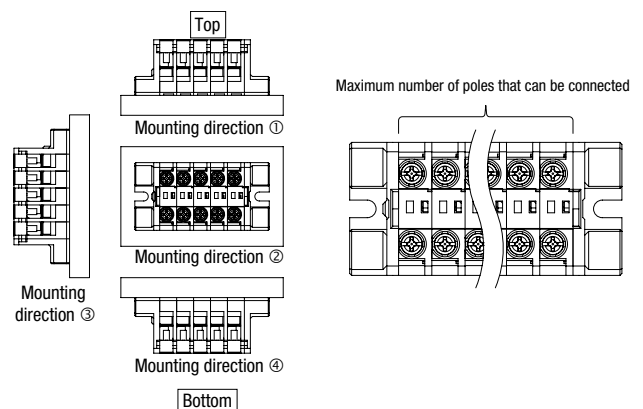

Instructions

How to use the joint plate

- Install a joint plate BTBHJ15 (for BTBH15/15L/30-H) at the required position so that it does not exceed the maximum number of terminal blocks that can be connected.

Joint plates are not available for BTBH50-H.

To assemble, install the recessed and protruded sides to fit the sides of the terminal block, and then twist.

To remove the joint plate, twist in the opposite direction of when it was assembled.

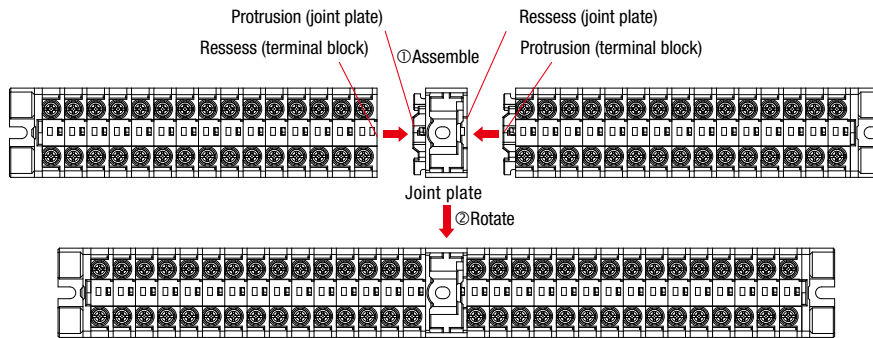

- Use the below screws when installing the joint plate.

Joint plate mounting screws

Part No.	Mounting screw	Recommended tightening torque (N·m)
BTBHJ15	M4 screw + M4 plain washer or M4 screw + M4 plain washer + M4 spring washer (No.2)	1.0 to 1.2

- When ordering an assembled product, order the joint plate BTBHJ15 (for BTBH15/15L/30-H) when installing in mounting direction ④. (See figure on bottom of page 15). The required number of joint plates are as follows.

Required number of joint plates (mounting direction ④)

No. of poles	Required quantity
2 to 6 poles	0
7 to 12 poles	1
13 to 18 poles	2
19 to 24 poles	3 (*1) (*2)
25 to 30 poles	4 (*1) (*2)

\*1) For BTBH15/15L-H21 to 30 (21 to 30 poles), one joint plate is supplied.

\*2) For BTBH30-H16 to 30 (16 to 30 poles), one joint plate is supplied.

- Do not use the product in the following environment. The connecting part may be detached.
  - (1) Environment where the product is exposed to chemicals or oil
  - (2) Where the product is subjected to strong shock or vibration
  - (3) Environment where the product is constantly subjected to tensile force from electric wires
  - (4) Locations where the temperature, temperature, or humidity exceeds the specifications



Instructions

Marking strips, dust covers

- Markings can be labeled directly on the terminal block. See the figure below for the location.  
The width of the marking should be 9.4mm maximum.  
The length is 2.5mm less than the dimension in the "Dimension calculation" table on the right.

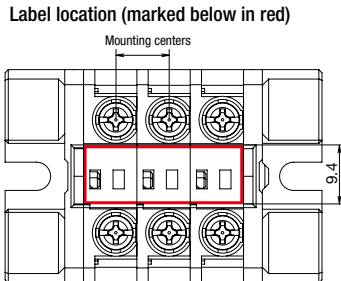

- blocks are assembled.  
When a dust cover is used, the product height will be 2mm higher. See below for details.  
Slight dimensional difference may occur when installed.

Terminal block height with dust cover installed (Example: BTBH15-H)

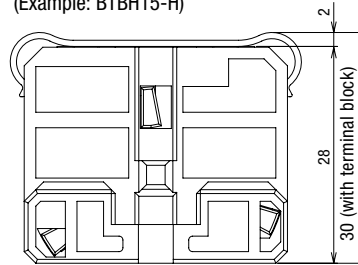

- When using the marking strip, calculate the length as shown in the "Dimension calculation" table on the right.  
A slight dimensional difference may occur when many terminal blocks are assembled.
- When using a dust cover, calculate the length as shown in the "Dimension Calculation" table on the right.  
A slight dimensional difference may occur when many terminal

- Dimension calculation (mm)  
n: Number of terminal block bodies  
m: Number of joint plates

Part No.	Dimension calculation
BTBH15-H□	8.5 x n + 2.5 + 15.8 x m
BTBH15L-H□	10.5 x n + 2.5 + 15.8 x m
BTBH30-H□	12 x n + 2.5 + 15.8 x m
BTBH50-H□	15.5 x n + 2.5 + 15.8 x m

Selecting Terminal Blocks by Current According to JIS Standards

IDEC's terminal blocks are compliant with JIS C 2811.

The current varies depending on the operating conditions (wire types, number of bundle wires, operating temperature, etc.). See the table below to choose the terminal block. When using the terminal blocks as UL, CSA, and TÜV approved products, refer to UL, CSA, and TÜV ratings.

Rated applicable wire (mm <sup>2</sup> )	1.25	2	3.5	5.5	14	22	38	60	100	150	200	240	325	
Current flow (A)	16	21	30	40	70	94	132	175	240	310	370	430	520	
Current vs. temperature rise at bus bars	(1)	(2)	(3)	(4)	(5)	(6)	(7)	(8)	(9)	(10)	(11)	(12)	(13)	
Compatible terminal blocks	BN-W BNH-W Series	BN10W BNH10W BN15MW BNH15MW BND15W BNDH15W	BN15LW BNH15LW BN15MWT BNH15MWT BND15LW BNDH15LW BND15WT BNDH15WT	BN15LWT BNH15LWT	BN30W BNH30W	BN50W BNH50W	BN75W	BN100W	BN150W BN150NW	BN200W BN200NW	BN300W BN300NW	BN400W BN400NW	BN500W BN500NW	BN600W
	BA Series	BA111T	BA111T BA211T	-	BA311T	BA411S	BA611S	BA711S	-	BA811S	-	BA911S	-	
	BTBH-H Series	BTBH15-H	BTBH15L-H	-	BTBH30-H	BTBH50-H	-							

Figure 1: Current vs. Temperature Rise at Bus Bars

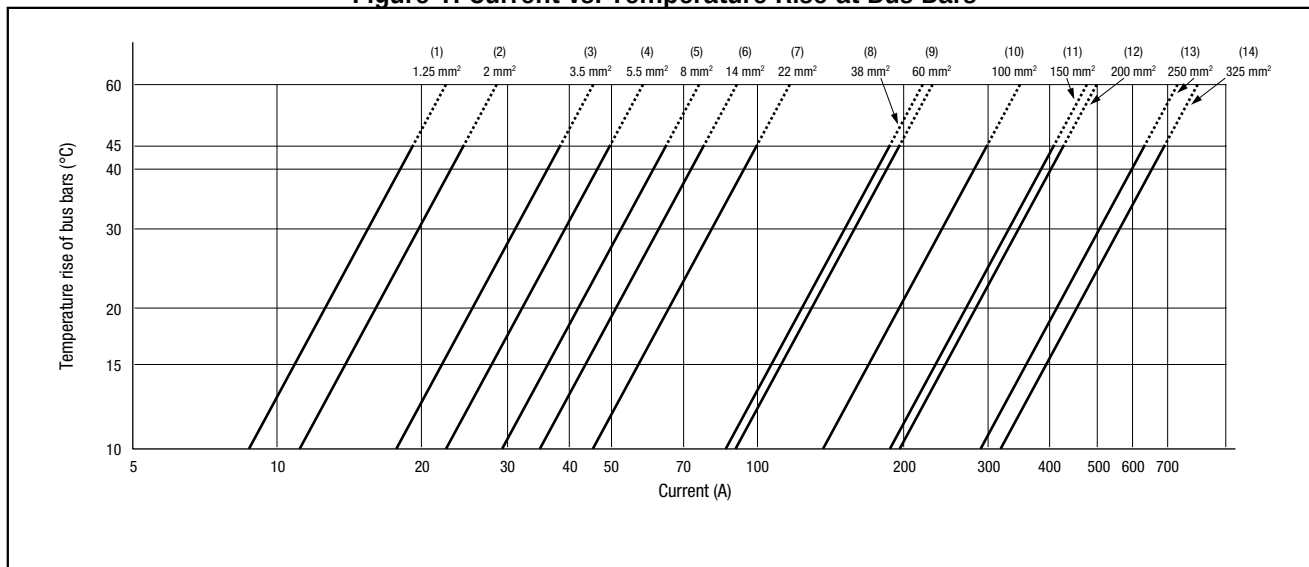

Note) The graph in Fig. 1 shows current vs. temperature rise at bus bars for a typical terminal block with applicable wires. Test conditions are in accordance with JIS C 8201-7-1.

**How to read the graph**

When using IDEC terminal blocks, make sure that the operating temperature and the temperature of the bus bars do not exceed 100°C. However, the upper limit of the temperature rise is limited to 45°C by JIS C 2811.

Operating temperature + Temperature rise at bus bars ≤ 100°C

Note) Select wires according to the allowable temperature, operating temperature, and temperature rise of bus bars.

**SCCR of Terminal Blocks**

When exporting machine or systems to the USA, the smallest short-circuit current rating of the control board's main circuit must be displayed as SCCR (short-circuit current rating) value.

SCCR is specified by UL508A-2001, Supplement SB, Table SB4.1. The value is 10kA for terminal block.

**Safety Precautions** ⚠

- Turn off the power before starting installation, removal, wiring, maintenance, and inspection of the products. Do not touch the terminals of the switching power supply while input voltage is applied. Failure to turn power off may cause electrical shock or fire.
- For wiring, use wires of proper size to meet voltage and current requirements. Tighten the terminal screws to the recommended tightening torque. Failure to tighten the terminal screws may cause overheating and fire. Also, the screws may become loose due to vibrations. Tighten regularly.
- Be sure to use the product within the rated specifications. Failure to turn power off may cause electrical shock or fire.
- The recommended tightening torque is shown below:

Screw Size	Tightening torque (N·m)	Screw Size	Tightening torque (N·m)
M3	0.6 to 1.0	M6	3.9 to 5.4
M3.5	1.0 to 1.3	M8	10 to 13.5
M4	1.4 to 2.0	M10	21 to 28
M5	2.6 to 3.7	M12	38 to 49
		M16	83 to 116

- For large capacity types, take into consideration the tension of the wires and tightening torque and make sure that the crimping terminals are not twisted.
- The plus and minus slots on the hex bolt head of large capacity terminal blocks are for temporary tightening only. To tighten, use an applicable socket wrench and tighten within the range of the recommended tightening torque.
- Use an insulated crimping terminal.
- Be sure to tighten the screws of unwired terminals.

## Ordering Terms and Conditions

Thank you for using IDEC Products.

By purchasing products listed in our catalogs, datasheets, and the like (hereinafter referred to as "Catalogs") you agree to be bound by these terms and conditions. Please read and agree to the terms and conditions before placing your order.

### 1. Notes on contents of Catalogs

- (1) Rated values, performance values, and specification values of IDEC products listed in this Catalog are values acquired under respective conditions in independent testing, and do not guarantee values gained in combined conditions.  
Also, durability varies depending on the usage environment and usage conditions.
- (2) Reference data and reference values listed in Catalogs are for reference purposes only, and do not guarantee that the product will always operate appropriately in that range.
- (3) The specifications / appearance and accessories of IDEC products listed in Catalogs are subject to change or termination of sales without notice, for improvement or other reasons.
- (4) The content of Catalogs is subject to change without notice.

### 2. Note on applications

- (1) If using IDEC products in combination with other products, confirm the applicable laws / regulations and standards.  
Also, confirm that IDEC products are compatible with your systems, machines, devices, and the like by using under the actual conditions. IDEC shall bear no liability whatsoever regarding the compatibility with IDEC products.
- (2) The usage examples and application examples listed in Catalogs are for reference purposes only. Therefore, when introducing a product, confirm the performance and safety of the instruments, devices, and the like before use. Furthermore, regarding these examples, IDEC does not grant license to use IDEC products to you, and IDEC offers no warranties regarding the ownership of intellectual property rights or non-infringement upon the intellectual property rights of third parties.
- (3) When using IDEC products, be cautious when implementing the following.
  - i. Use of IDEC products with sufficient allowance for rating and performance
  - ii. Safety design, including redundant design and malfunction prevention design that prevents other danger and damage even in the event that an IDEC product fails
  - iii. Wiring and installation that ensures the IDEC product used in your system, machine, device, or the like can perform and function according to its specifications
- (4) Continuing to use an IDEC product even after the performance has deteriorated can result in abnormal heat, smoke, fires, and the like due to insulation deterioration or the like. Perform periodic maintenance for IDEC products and the systems, machines, devices, and the like in which they are used.
- (5) IDEC products are developed and manufactured as general-purpose products for general industrial products. They are not intended for use in the following applications, and in the event that you use an IDEC product for these applications, unless otherwise agreed upon between you and IDEC, IDEC shall provide no guarantees whatsoever regarding IDEC products.
  - i. Use in applications that require a high degree of safety, including nuclear power control equipment, transportation equipment (railroads / airplanes / ships / vehicles / vehicle instruments, etc.), equipment for use in outer space, elevating equipment, medical instruments, safety devices, or any other equipment, instruments, or the like that could endanger life or human health
  - ii. Use in applications that require a high degree of reliability, such as provision systems for gas / waterworks / electricity, etc., systems that operate continuously for 24 hours, and settlement systems
  - iii. Use in applications where the product may be handled or used deviating from the specifications or conditions / environment listed in the Catalogs, such as equipment used outdoors or applications in environments subject to chemical pollution or electromagnetic interference  
If you would like to use IDEC products in the above applications, be sure to consult with an IDEC sales representative.

### 3. Inspections

We ask that you implement inspections for IDEC products you purchase without delay, as well as thoroughly keep in mind management/maintenance regarding handling of the product before and during the inspection.

### 4. Warranty

#### (1) Warranty period

The warranty period for IDEC products shall be one (1) year after purchase or delivery to the specified location. However, this shall not apply in cases where there is a different specification in the Catalogs or there is another agreement in place between you and IDEC.

#### (2) Warranty scope

Should a failure occur in an IDEC product during the above warranty period for reasons attributable to IDEC, then IDEC shall replace or repair that product, free of charge, at the purchase location / delivery location of the product, or an IDEC service base. However, failures caused by the following reasons shall be deemed outside the scope of this warranty.

- i. The product was handled or used deviating from the conditions / environment listed in the Catalogs
  - ii. The failure was caused by reasons other than an IDEC product
  - iii. Modification or repair was performed by a party other than IDEC
  - iv. The failure was caused by a software program of a party other than IDEC
  - v. The product was used outside of its original purpose
  - vi. Replacement of maintenance parts, installation of accessories, or the like was not performed properly in accordance with the user's manual and Catalogs
  - vii. The failure could not have been predicted with the scientific and technical standards at the time when the product was shipped from IDEC
  - viii. The failure was due to other causes not attributable to IDEC (including cases of force majeure such as natural disasters and other disasters)
- Furthermore, the warranty described here refers to a warranty on the IDEC product as a unit, and damages induced by the failure of an IDEC product are excluded from this warranty.

### 5. Limitation of liability

The warranty listed in this Agreement is the full and complete warranty for IDEC products, and IDEC shall bear no liability whatsoever regarding special damages, indirect damages, incidental damages, or passive damages that occurred due to an IDEC product.

### 6. Service scope

The prices of IDEC products do not include the cost of services, such as dispatching technicians. Therefore, separate fees are required in the following cases.

- (1) Instructions for installation / adjustment and accompaniment at test operation (including creating application software and testing operation, etc.)
- (2) Maintenance inspections, adjustments, and repairs
- (3) Technical instructions and technical training
- (4) Product tests or inspections specified by you

The above content assumes transactions and usage within your region. Please consult with an IDEC sales representative regarding transactions and usage outside of your region. Also, IDEC provides no guarantees whatsoever regarding IDEC products sold outside your region.

# IDEC CORPORATION

**Head Office** 6-64, Nishi-Miyahara-2-Chome, Yodogawa-ku, Osaka 532-0004, Japan

 [www.idec.com](http://www.idec.com)

<b>USA</b>	IDEC Corporation	<b>Singapore</b>	IDEC Izumi Asia Pte. Ltd.	<b>China</b>	IDEC (Shanghai) Corporation	<b>Japan</b>	IDEC Corporation
<b>EMEA</b>	APEM SAS	<b>Thailand</b>	IDEC Asia (Thailand) Co., Ltd.		IDEC Izumi (H.K.) Co., Ltd.		
		<b>India</b>	IDEC Controls India Private Ltd.	<b>Taiwan</b>	IDEC Taiwan Corporation		

Specifications and other descriptions in this brochure are subject to change without notice.

Information in this brochure is current as of January, 2023.

2023 IDEC Corporation, All Rights Reserved.

EP1772-1



# Mouser Electronics

Authorized Distributor

Click to View Pricing, Inventory, Delivery & Lifecycle Information:

## IDEC:

[BTBH15-H10](#) [BTBH15-H11](#) [BTBH15-H12](#) [BTBH15-H13](#) [BTBH15-H14](#) [BTBH15-H15](#) [BTBH15-H16](#) [BTBH15-H17](#)  
[BTBH15-H18](#) [BTBH15-H19](#) [BTBH15-H2](#) [BTBH15-H20](#) [BTBH15-H21](#) [BTBH15-H22](#) [BTBH15-H23](#) [BTBH15-H24](#)  
[BTBH15-H25](#) [BTBH15-H26](#) [BTBH15-H27](#) [BTBH15-H28](#) [BTBH15-H29](#) [BTBH15-H3](#) [BTBH15-H30](#) [BTBH15-H4](#)  
[BTBH15-H5](#) [BTBH15-H6](#) [BTBH15-H7](#) [BTBH15-H8](#) [BTBH15-H9](#) [BTBH15-HPN](#) [BTBH15L-H10](#) [BTBH15L-H11](#)  
[BTBH15L-H12](#) [BTBH15L-H13](#) [BTBH15L-H14](#) [BTBH15L-H15](#) [BTBH15L-H16](#) [BTBH15L-H17](#) [BTBH15L-H18](#)  
[BTBH15L-H19](#) [BTBH15L-H2](#) [BTBH15L-H20](#) [BTBH15L-H21](#) [BTBH15L-H22](#) [BTBH15L-H23](#) [BTBH15L-H24](#)  
[BTBH15L-H25](#) [BTBH15L-H26](#) [BTBH15L-H27](#) [BTBH15L-H28](#) [BTBH15L-H29](#) [BTBH15L-H3](#) [BTBH15L-H30](#)  
[BTBH15L-H4](#) [BTBH15L-H5](#) [BTBH15L-H6](#) [BTBH15L-H7](#) [BTBH15L-H8](#) [BTBH15L-H9](#) [BTBH15L-HPN](#) [BTBH30-H10](#)  
[BTBH30-H11](#) [BTBH30-H12](#) [BTBH30-H13](#) [BTBH30-H14](#) [BTBH30-H15](#) [BTBH30-H16](#) [BTBH30-H17](#) [BTBH30-H18](#)  
[BTBH30-H19](#) [BTBH30-H2](#) [BTBH30-H20](#) [BTBH30-H21](#) [BTBH30-H22](#) [BTBH30-H23](#) [BTBH30-H24](#) [BTBH30-H25](#)  
[BTBH30-H26](#) [BTBH30-H27](#) [BTBH30-H28](#) [BTBH30-H29](#) [BTBH30-H3](#) [BTBH30-H30](#) [BTBH30-H4](#) [BTBH30-H5](#)  
[BTBH30-H6](#) [BTBH30-H7](#) [BTBH30-H8](#) [BTBH30-H9](#) [BTBH30-HPN](#) [BTBH50-H10](#) [BTBH50-H11](#) [BTBH50-H12](#)  
[BTBH50-H13](#) [BTBH50-H14](#) [BTBH50-H15](#) [BTBH50-H2](#) [BTBH50-H3](#) [BTBH50-H4](#) [BTBH50-H5](#)