

# Common Point Grounding Units Installation Instructions



Made in the  
United States of America

## Description

Per ANSI/ESD S20.20, all conductors, including personnel, must be electrically connected and attached to a known ground. EOS/ESD S6.1 recommends hard ground, without resistor, of worksurface or floor mats. Per ANSI/ESD S20.20, ground fault circuit interrupters (GFCI) should be considered to provide personnel protection.

Desco offers a number of common point grounds and wrist strap ground connectors designed to ground multiple operators or items.

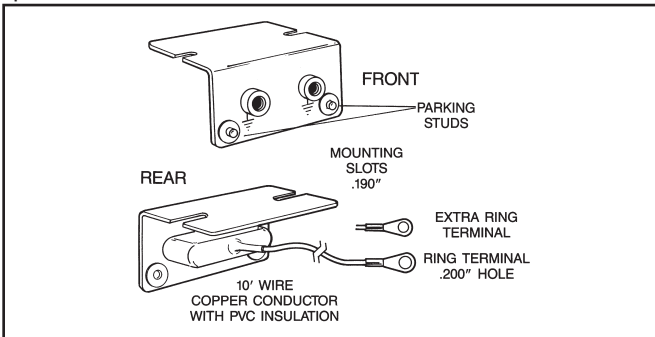

Figure 1. 09740/09741 wrist strap bench ground.

The [09740/09741](#) wrist strap bench ground is a wrist strap ground connector and consists of a mounting bracket with two standard banana jacks installed and soldered to a ten foot ground wire terminated with a ring terminal with a 0.200" hole.

The [09741](#) includes a wrist strap parking station. See figure 2.

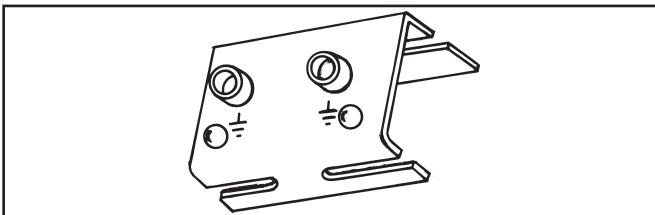

Figure 2. 09741 premium bench mounted ground with parking station

The [09842](#) Multi Grounding Hub is designed for use as either a wrist strap ground connector or as a common point ground for all items to be grounded at a bench (i.e. table mat ground cord, floor mat ground cord, banana jack ground block, etc.). The Multi Grounding Hub incorporates six standard banana jacks, and six terminations for ring terminals (10-32 screw in threaded holes).

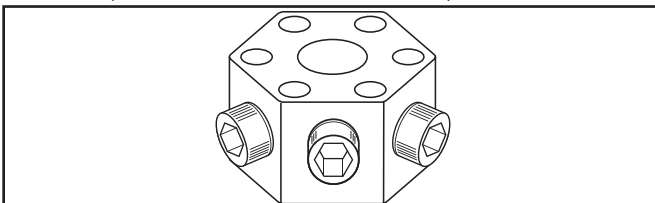

Figure 3. 09842 Multi Grounding Hub

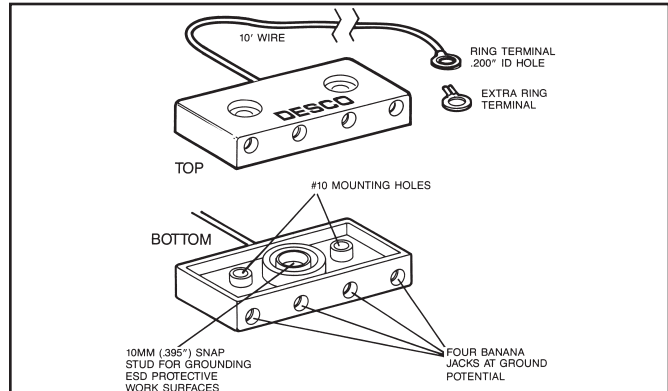

Figure 4. 09835/09836 quad common point ground

The [09835/09836](#) quad common point ground is designed for use as either a wrist strap ground connector or as a common point ground. The quad ground incorporates four standard banana jacks, a 10mm snap stud, and ten feet of ground wire terminated with a ring terminal with a 0.200" I.D. hole. The model [09835](#) also incorporates a 1 megohm resistor in series with the snap stud.

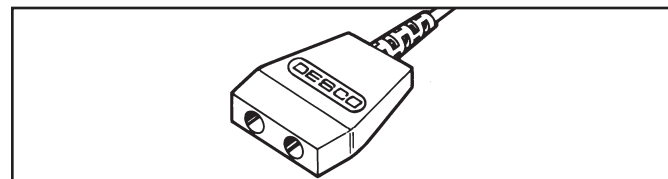

Figure 5. 09820/09821/09825/09826 common point ground.

The [09820/09821/09825/09826](#) common point ground is designed to ground bench mats by snapping on the mat's stud, and to provide a convenient wrist strap ground connector. Items [09820/09821](#) incorporate two standard banana jacks, a 10mm snap socket, and 10 feet of wire terminated with a ring terminal with a 0.200" I.D. hole. Items [09825/09826](#) have a 10mm snap stud and 15 feet of wire. Items [09821/09826](#) also incorporate a one megohm resistor in series with the snap.

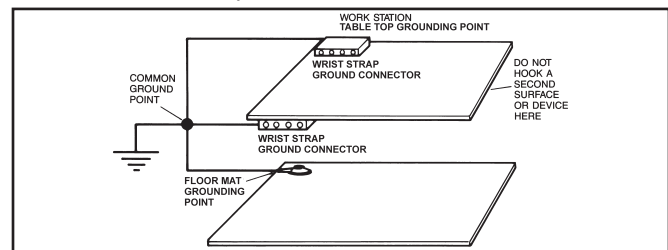

Figure 6. All elements at the ESD work station should be connected to the same common point ground, such as 09842 Multi Grounding Hub.

The [09740/09741](#), [09835/09836](#) and [09820/09821/09825/09826](#) are shipped with an extra ring terminal so that the ground wire may be cut to length during installation. The [09740/09741](#) and [09835/09836](#) feature a pair of mounting holes designed to accommodate standard #10 screws, allowing the units to be mounted to the work bench.

## Proper Grounding

Wrist straps, work surfaces, floor mats and other electrostatic discharge (ESD) protective products should be grounded to a common point ground.

### COMMON POINT GROUND

Per ANSI/EOS/ESD S6.1, Grounding paragraph 4.1.1 “Every element to be grounded at an ESD protected station shall be connected to the same common point ground.”

ESD Handbook TR 20.20 paragraph 5.1.3 Basic Grounding Requirements “The first step in ensuring that everything in an EPA is at the same electrical potential is to ground all conductive components of the work area (worksurfaces, people, equipment, etc.) to the same electrical ground point. This point is called the common point ground. The next step in completing the ground circuit is to connect the common point ground to the equipment ground (third wire, green).”

If all elements are connected to the common point ground, even if the equipment ground connection is compromised, all workstation elements will be connected and be at equipotential or at the same charge. Being at the same electrostatic charge will mean that no discharge should occur.

Connect the ground wire directly to the nearest utility “green wire” ground point. In a properly wired building, the “green wire” equipment ground point may be the center screw of the standard 110VAC outlet. Some special outlets may “float” the center screw. Test before you hook up.

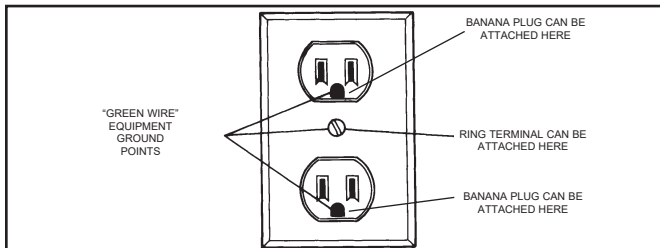

Figure 7. Recommended grounding point.

Individual work stations must be individually grounded to the “green wire” equipment ground. For ESD worksurface installation information, see Desco Technical Bulletin TB-2000.

## Always Test the Ground Before You Use It and Periodically Thereafter

You should not assume that any electrical outlet is properly wired. Even if it was originally wired correctly, it can become ungrounded due to corrosion and wear. Test the equipment ground you intend to use before you hook up. Use Desco 98130 AC Outlet Analyzer to verify proper wiring of the electrical outlet (equipment ground).

## Installation

After you have selected and tested your grounding point, you will need to determine the method of installation for the type of grounding block that you have selected. Installation of common point units as grounding blocks is outlined below. Installation of the [09835/09836](#) and [09820/09821/09825/09826](#) as common point ground cords for a work surfaces is also discussed below.

### WRIST STRAP GROUND CONNECTORS

1. Select the most convenient location on the work bench for grounding of wrist straps and other grounding devices.
2. Position the [09740/09741](#) or [09835/09836](#) and use the two #10 mounting holes to secure to the work bench.
3. Bring the wire neatly back to your grounding point. You may wish to use wire brackets to hold the wire in place and out of the way. Cut and strip the end of the wire to properly fit your ground point. Install and crimp the extra ring terminal provided.

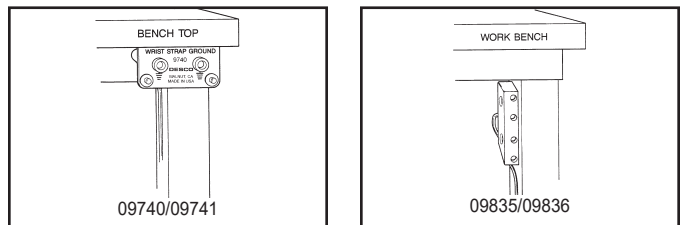

Figure 8. Installation of grounding blocks.

4. To check resistance, use an ohmmeter from the banana jacks to the common ground point. It should read less than 1 Ohm AC impedance for items [09740/09741](#), [09820/09825](#) and [09835](#) and 1 megohm ( $10^6$  ohms) for items [09836](#) and [09821/09826](#).

### GROUNDING POINT

As previously mentioned, the [09835/09836](#) and the [09820/09821/09825/09826](#) can be installed as a wrist strap ground connector for ESD protective work surfaces.

1. Position or lay the work surface in the desired location. Snap the ground to it. These units connect with a 10mm socket snap.

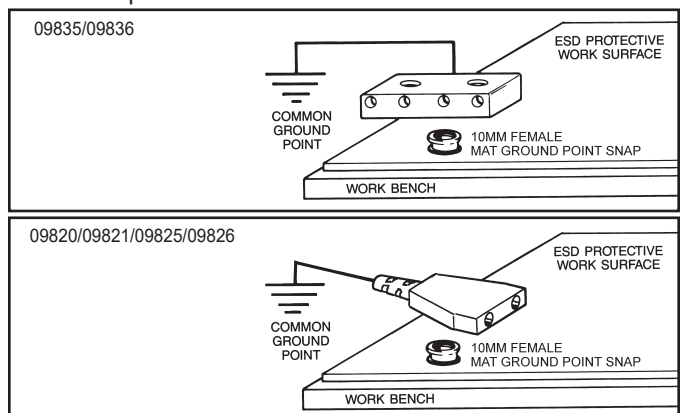

Figure 9. Installing the 09835/09836 and 09820/09821/09825/09826 as a common point ground cord for a work surface.

2. Bring the other end of the ground cord to a verified grounding point and attach it using the ring terminal. Tie the ground wire to the bench to keep it neatly out of the way. You may cut and strip the ground wire to a shorter length and attach it using the extra ring terminal included with each ground cord.

3. After installation, the work surface along with the banana jacks are all electrically connected to ground. The banana jacks will now serve as wrist strap ground connectors.

4. To check resistance, use an ohmmeter from the ground point snap on the mat to the common ground point. It should read 1 megohm  $\pm$ 20 percent if you are using a model [09836](#), [09821](#), or [09826](#) ground cord, and less than 1 Ohm AC impedance if you are using a [09835](#), [09820](#), or [09825](#) non-resistor ground cord.

### MULTI GROUNDING HUB

The [09842](#) Multi Grounding Hub can be mounted either on a bench leg or table top.

See *Figure 10 for installation.*

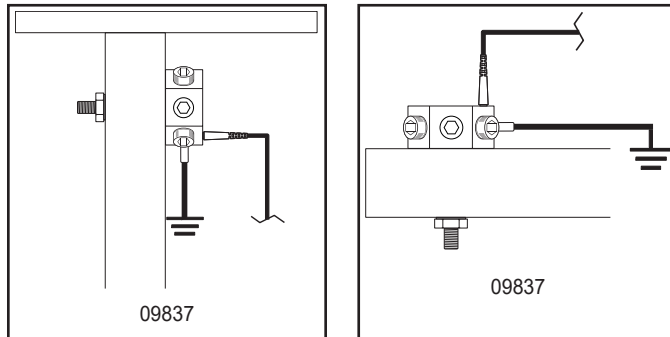

*Figure 10. Installation of multi grounding hub.*

### Maintenance

You should set up a an auditing schedule to be sure that all ESD grounds are inspected and tested per your compliance verification plan required by ANSI/ESD S20.20. Some companies test once every six months.

### Limited Warranty, Warranty Exclusions, Limit of Liability and RMA Request Instructions

See [Desco Terms and Conditions](#)

# Mouser Electronics

Authorized Distributor

Click to View Pricing, Inventory, Delivery & Lifecycle Information:

[Desco:](#)

[09826](#) [14213](#)