

GaN Amplifier 28 V, 12.5 W 20 - 1000 MHz



NPA1006

Rev. V5

Features

- GaN on Si HEMT D-Mode Amplifier
- Suitable for Linear & Saturated Applications
- Broadband Operation from 20 - 1000 MHz
- 50 Ω Input Matched, Output Unmatched
- 28 V Operation
- 14 dB Gain @ 900 MHz
- 65% Drain Efficiency @ 900 MHz
- 100% RF Tested
- Lead-Free 6 x 5 mm 8-lead PDFN Package
- Halogen-Free “Green” Mold Compound
- RoHS* Compliant



Description

The NPA1006 is a GaN on silicon amplifier optimized for 20 - 1000 MHz operation. This amplifier has been designed for saturated and linear operation with output levels to 12.5 W (41 dBm) assembled in a lead-free 6 x 5 mm 8-lead PDFN plastic package.

The NPA1006 is ideally suited for general purpose narrowband to broadband applications in test and measurement, defense communications, land mobile radio and wireless infrastructure.

Functional Schematic

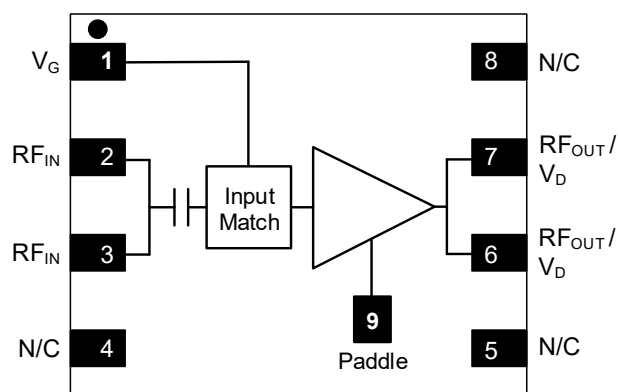

Pin Designations

Pin #	Pin Name	Function
1	V _G	Gate Voltage
2, 3	RF _{IN}	RF Input
4, 5	N/C ²	No Connection
6, 7	RF _{OUT} / V _D	RF Output / Drain Voltage
8	N/C ²	No Connection
9	Paddle ³	Ground

Ordering Information¹

Part Number	Package
NPA1006	Bulk Quantity
NPA1006-TR0500	500 piece reel
NPA1006-SMB	Sample Board

1. Reference Application Note M513 for reel size information.

2. All no connection pins may be left floating or grounded.

3. The exposed pad centered on the package bottom must be connected to RF and DC ground. This path must also provide a low thermal resistance heat path.

* Restrictions on Hazardous Substances, compliant to current RoHS EU directive.

GaN Amplifier 28 V, 12.5 W 20 - 1000 MHz



NPA1006

Rev. V5

RF Electrical Specifications:

$T_C = 25^\circ\text{C}$, $V_{DS} = 28\text{ V}$, $I_{DQ} = 88\text{ mA}$, 100 - 1000 MHz Broadband Characterization Circuit

Parameter	Test Conditions	Symbol	Min.	Typ.	Max.	Units
Small Signal Gain	CW, 900 MHz	G_{SS}	-	15.0	-	dB
Gain	CW, $P_{OUT} = 41\text{ dBm}$, 900 MHz	G_P	12.5	14.0	-	dB
Saturated Output Power	CW, 900 MHz	P_{SAT}	-	42.9	-	dBm
Drain Efficiency	CW, $P_{OUT} = 41\text{ dBm}$, 900 MHz	η_D	61	65	-	%
Power Added Efficiency	CW, $P_{OUT} = 41\text{ dBm}$, 900 MHz	PAE	57.5	62.4	-	%
Drain Efficiency	CW, 900 MHz	η_{DSAT}	-	70	-	%
Drain Voltage (V_{DS})	Drain Voltage	V_{DS}	-	28	-	V
Ruggedness	All phase angles	Ψ	VSWR = 15:1, No Device Damage			

DC Electrical Specifications: $T_C = 25^\circ\text{C}$

Parameter	Test Conditions	Symbol	Min.	Typ.	Max.	Units
Drain-Source Leakage Current	$V_{GS} = -8\text{ V}$, $V_{DS} = 100\text{ V}$	I_{DLK}	-	6	-	mA
Gate-Source Leakage Current	$V_{GS} = -8\text{ V}$, $V_{DS} = 0\text{ V}$	I_{GLK}	-	3	-	mA
Gate Threshold Voltage	$V_{DS} = 28\text{ V}$, $I_D = 6\text{ mA}$	V_T	-2.5	-1.5	-0.5	V
Gate Quiescent Voltage	$V_{DS} = 28\text{ V}$, $I_D = 88\text{ mA}$	V_{GSQ}	-2.1	-1.2	-0.3	V
On Resistance	$V_{DS} = 2\text{ V}$, $I_D = 45\text{ mA}$	R_{ON}	-	0.8	-	Ω
Saturated Drain Current	$V_{DS} = 7\text{ V}$ pulsed, pulse width 300 μs	$I_{D(SAT)}$	-	3.5	-	A

GaN Amplifier 28 V, 12.5 W

20 - 1000 MHz



NPA1006
Rev. V5

Absolute Maximum Ratings^{3,4,5}

Parameter	Absolute Maximum
Drain Source Voltage, V_{DS}	100 V
Gate Source Voltage, V_{GS}	-10 to 3 V
Gate Current, I_G	12 mA
Junction Temperature, T_J	+200°C
Operating Temperature	-40°C to +85°C
Storage Temperature	-65°C to +150°C
ESD Min. - Human Body Model (HBM)	+500 V

3. Exceeding any one or combination of these limits may cause permanent damage to this device.
4. MACOM does not recommend sustained operation near these survivability limits.
5. Operating at nominal conditions with $T_J \leq 200^\circ\text{C}$ will ensure $\text{MTTF} > 1 \times 10^6$ hours.

Thermal Characteristics⁶

Parameter	Test Conditions	Symbol	Typical	Units
Thermal Resistance	$V_{DS} = 28 \text{ V}, T_J = 200^\circ\text{C}$	Θ_{JC}	4.6	°C/W

6. Junction temperature (T_J) measured using IR Microscopy. Case temperature measured using thermocouple embedded in heat-sink.

Handling Procedures

Please observe the following precautions to avoid damage:

Static Sensitivity

Gallium Nitride Circuits are sensitive to electrostatic discharge (ESD) and can be damaged by static electricity. Proper ESD control techniques should be used when handling these HBM Class 1B devices.

GaN Amplifier 28 V, 12.5 W 20 - 1000 MHz



NPA1006

Rev. V5

Characterization Circuit and Recommended Tuning Solution

100 - 1000 MHz Broadband

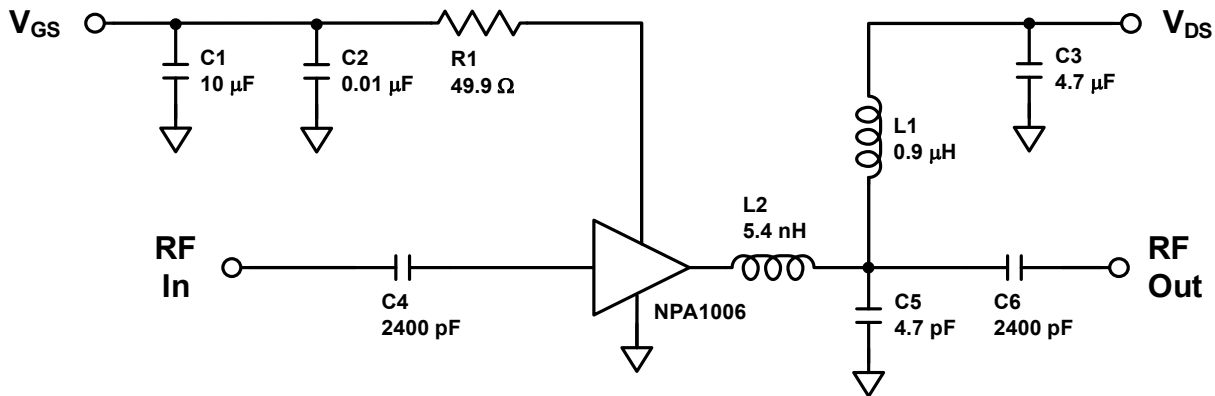

Description

Parts measured on the characterization board (20-mil thick RO4350). The PCB's electrical and thermal ground is provided using a standard-plated densely packed via hole array (see recommended via pattern).

Matching is provided using a combination of lumped elements and transmission lines as shown in the simplified schematic above. Recommended tuning solution component placement, transmission lines, and details are shown on the next page.

Bias Sequencing

Turning the device ON

1. Set V_{GS} to the pinch-off (V_P), typically -5 V.
2. Turn on V_{DS} to nominal voltage (28 V).
3. Increase V_{GS} until the I_{DS} current is reached.
4. Apply RF power to desired level.

Turning the device OFF

1. Turn the RF power off.
2. Decrease V_{GS} down to V_P .
3. Decrease V_{DS} down to 0 V.
4. Turn off V_{GS} .

Recommended Via Pattern (All dimensions shown as inches)

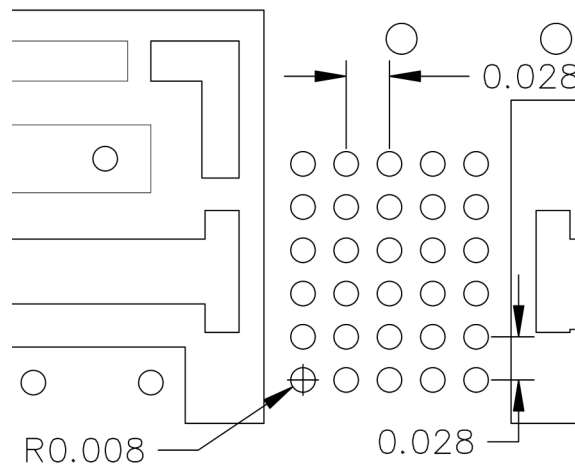

GaN Amplifier 28 V, 12.5 W 20 - 1000 MHz



NPA1006
Rev. V5

Characterization Circuit and Recommended Tuning Solution 100 - 1000 MHz Broadband

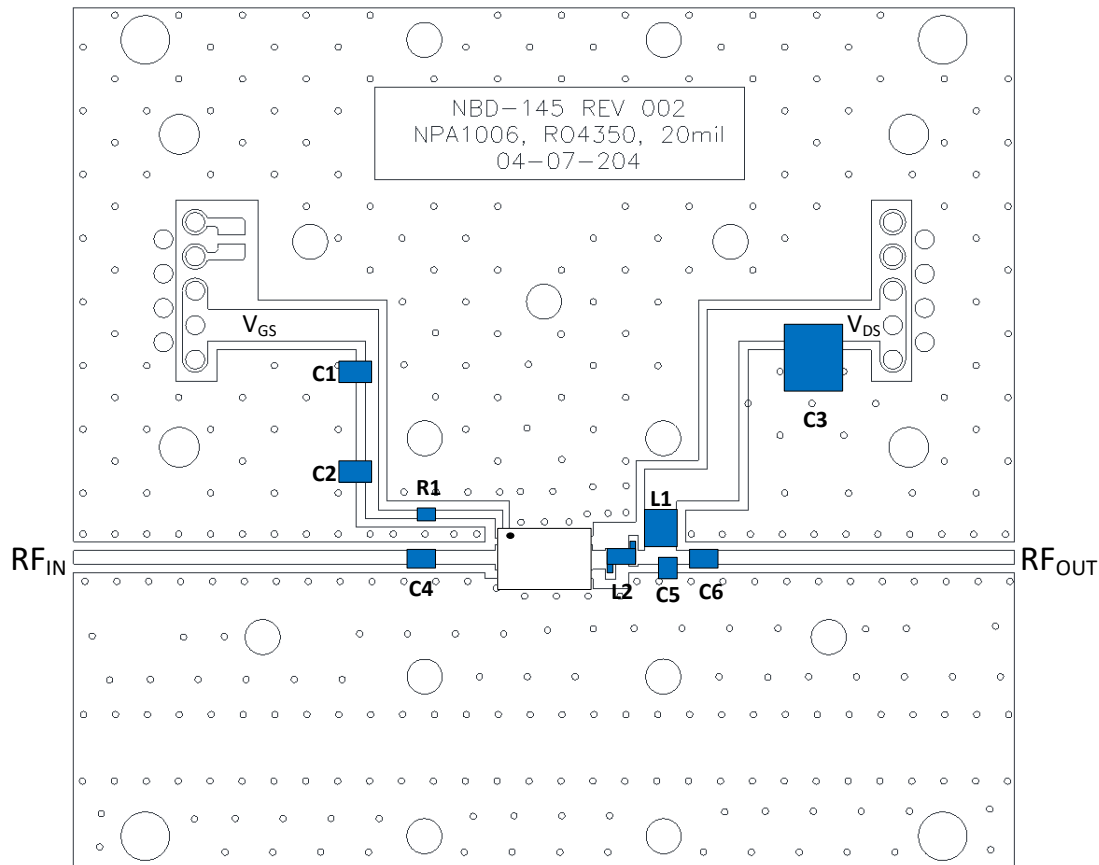

Parts List

Reference	Value	Tolerance	Manufacturer	Part Number
C1	10 μ F	20%	TDK	C2012X5R1C106M085AC
C2	0.01 μ F	10%	AVX	06031C103JAT2A
C3	4.7 μ F	10%	TDK	C5750X7R2A475K230KA
C4, C6	2400 pF	-	Dielectric Labs, Inc.	C08BL242X-5UN-X0
C5	4.7 pF	0.1 pF	Murata	GQM2195C2E4R7BB12
R1	49.9 Ω	1%	Panasonic	ERJ-6ENF49R9V
L1	0.9 μ H	10%	Coilcraft	1008AF-901XJLC
L2	5.4 nH	5%	Coilcraft	0906-5_LB
PCB	Rogers RO4350, $\epsilon_r=3.5$, 0.020"			
Heat Sink	Copper Heat Sink 3.0" x 2.75"			

GaN Amplifier 28 V, 12.5 W 20 - 1000 MHz



NPA1006

Rev. V5

Typical Performance

Measured in the Broadband 100 - 1000 MHz Characterization Circuit:

CW, $V_{DS} = 28$ V, $I_{DQ} = 88$ mA (unless otherwise noted)

Deembedded device S-Parameters with $R_G = 470 \Omega$

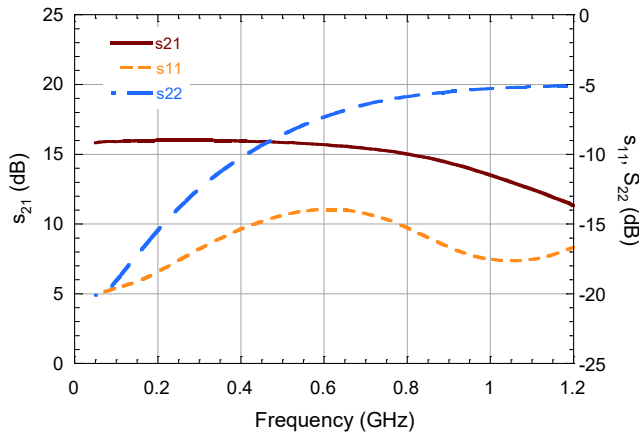

Broadband Circuit S-Parameters

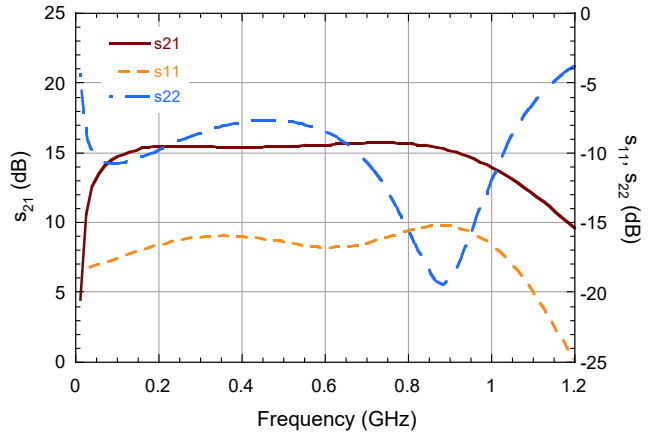

Performance vs. Frequency at $P_{OUT} = 41$ dBm

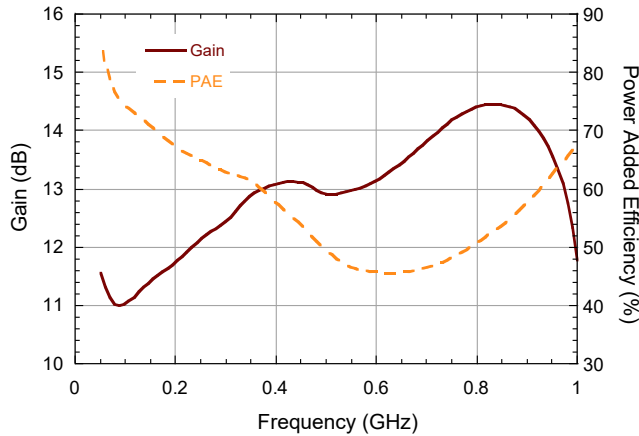

Performance vs. Input Return Loss at $P_{OUT} = 41$ dBm

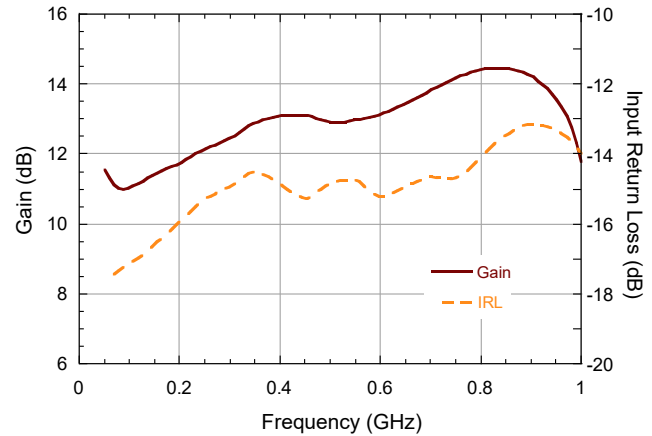

GaN Amplifier 28 V, 12.5 W 20 - 1000 MHz



NPA1006

Rev. V5

Typical Performance

Measured in the Broadband 100 - 1000 MHz Characterization Circuit:
CW, $V_{DS} = 28$ V, $I_{DQ} = 88$ mA (unless otherwise noted)

Gain vs. Frequency

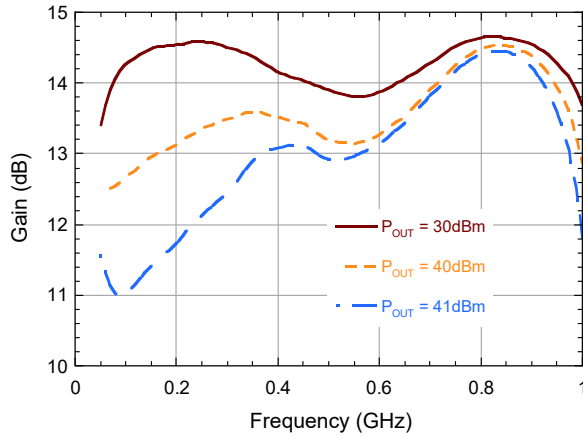

Gain vs. Frequency at $P_{IN} = 27$ dBm

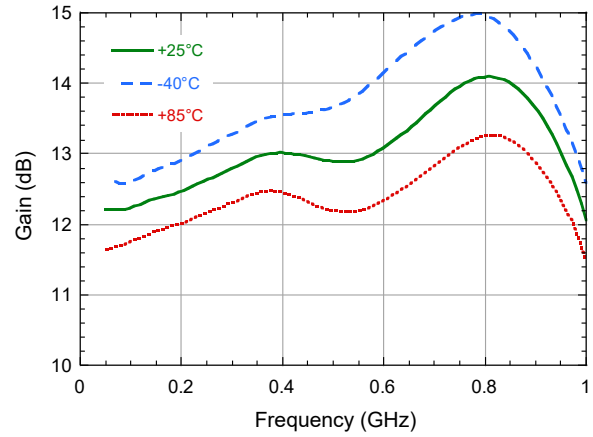

Input Return Loss vs. Frequency

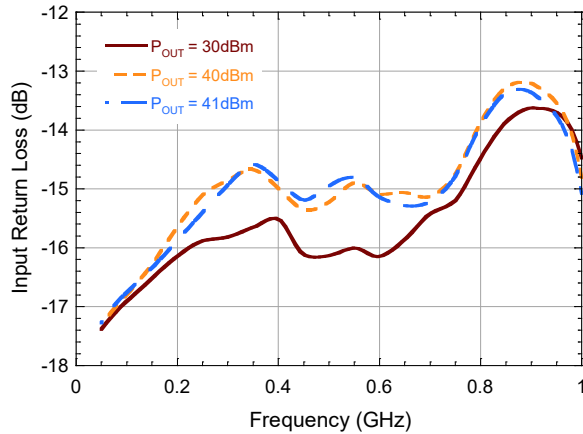

Input Return Loss at $P_{IN} = 27$ dBm vs. Frequency

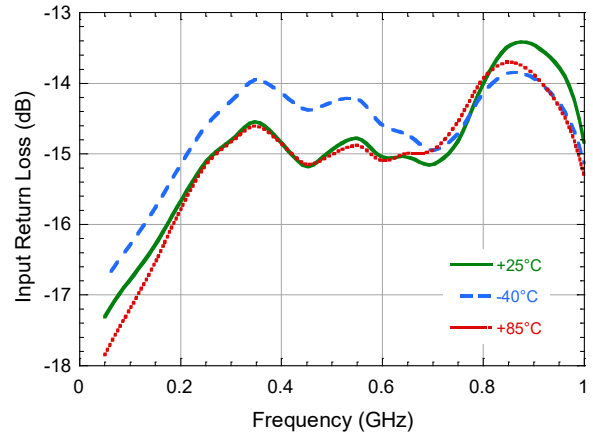

Power Added Efficiency vs. Frequency

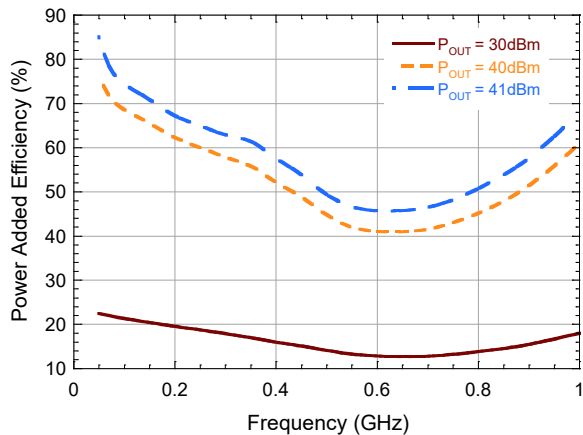

Power Added Efficiency at $P_{IN} = 27$ dBm vs. Frequency

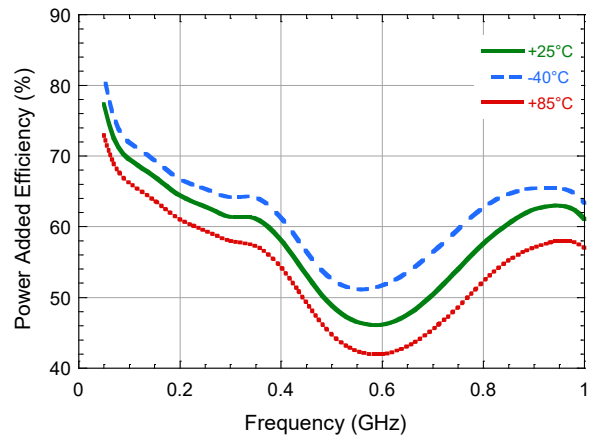

GaN Amplifier 28 V, 12.5 W 20 - 1000 MHz



NPA1006

Rev. V5

Typical Performance

Measured in the Broadband 100 - 1000 MHz Characterization Circuit:
CW, $V_{DS} = 28\text{ V}$, $I_{DQ} = 88\text{ mA}$ (unless otherwise noted)

Gain vs. P_{OUT}

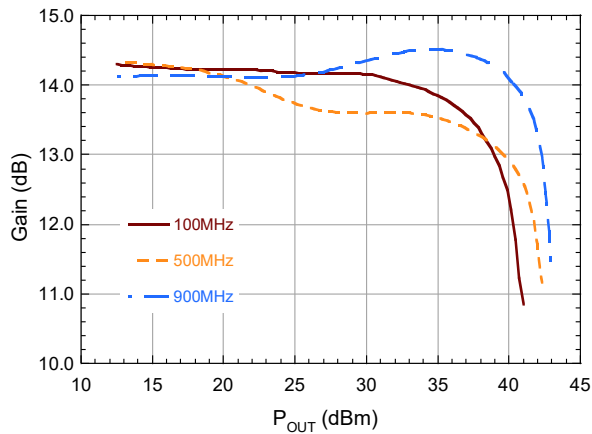

Power Added Efficiency vs. P_{OUT}

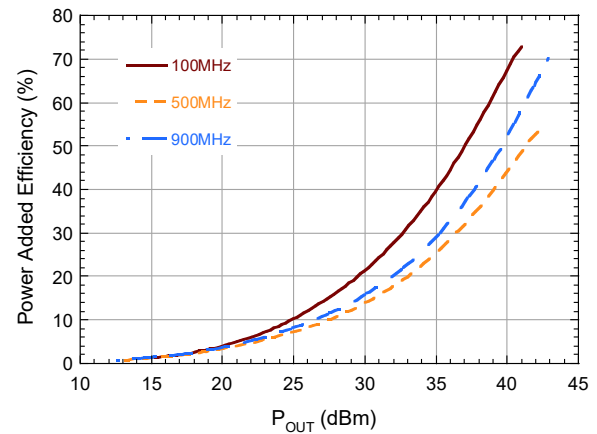

Input Return Loss vs. P_{OUT}

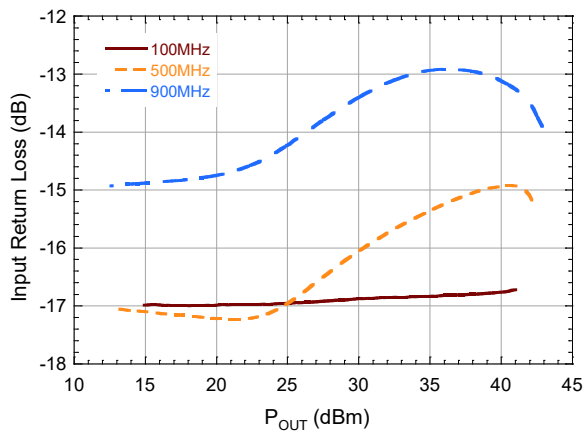

Quiescent V_{GS} vs. Temperature

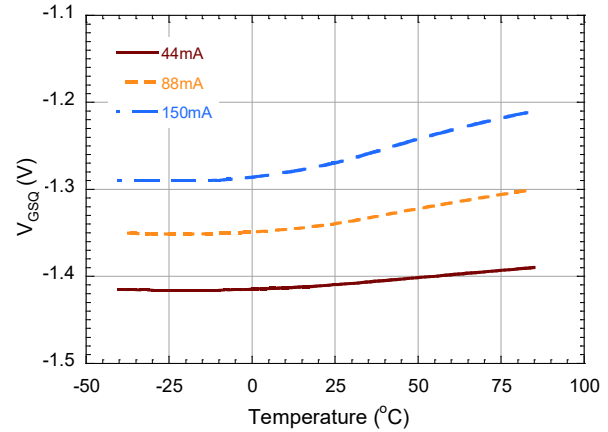

GaN Amplifier 28 V, 12.5 W 20 - 1000 MHz



NPA1006

Rev. V5

Typical 2-Tone Performance

Measured in the Broadband 100 - 1000 MHz Characterization Circuit:
1 MHz Tone Spacing, $V_{DS} = 28$ V, $I_{DQ} = 88$ mA (unless otherwise noted)

2-Tone IMD vs. Output Power vs. I_{DQ}

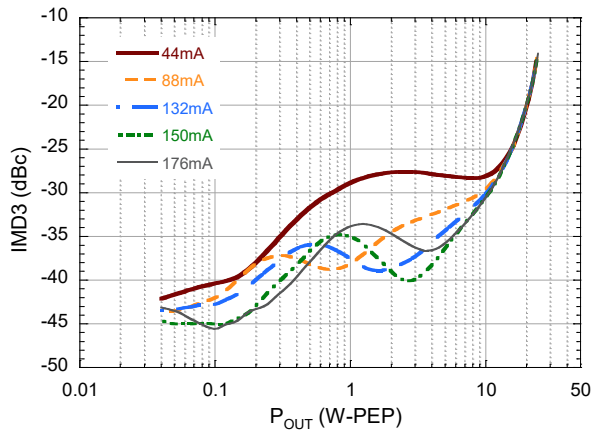

2-Tone Gain vs. Output Power vs. I_{DQ}

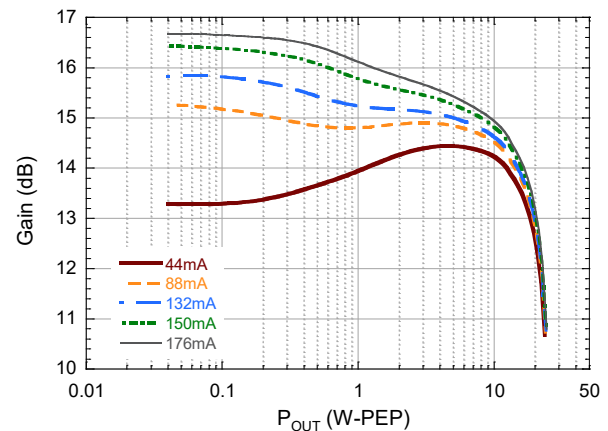

2-Tone IMD vs. Output Power
(1 MHz Tone Spacing, $I_{DQ} = 132$ mA, $F = 450$ MHz)

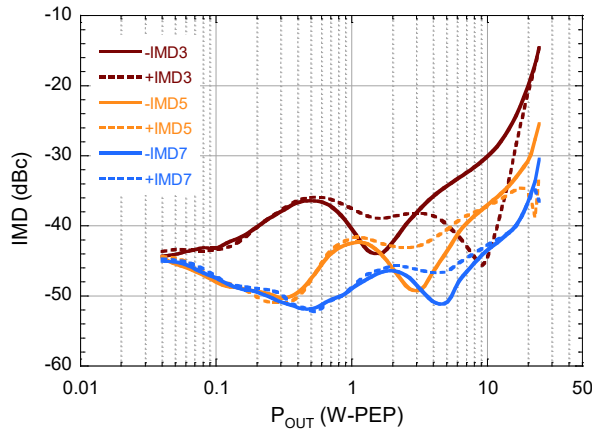

2-Tone IMD vs. Tone Spacing
($P_{OUT} = 41$ dBm-PEP, $I_{DQ} = 132$ mA, $F = 450$ MHz)

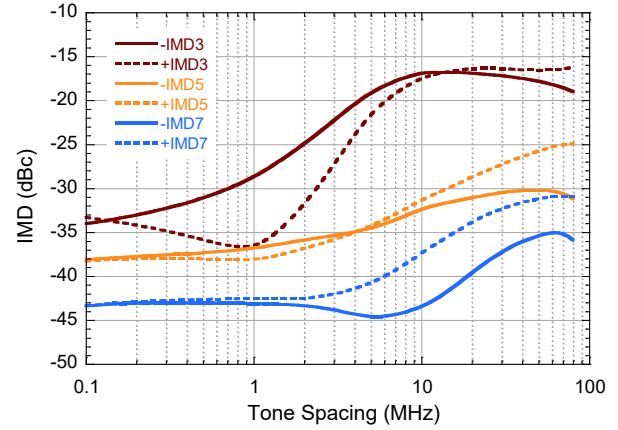

GaN Amplifier 28 V, 12.5 W 20 - 1000 MHz



NPA1006

Rev. V5

Sample Board and Recommended Tuning Solution

20 - 1000 MHz Broadband Circuit (NPA1006-SMB)

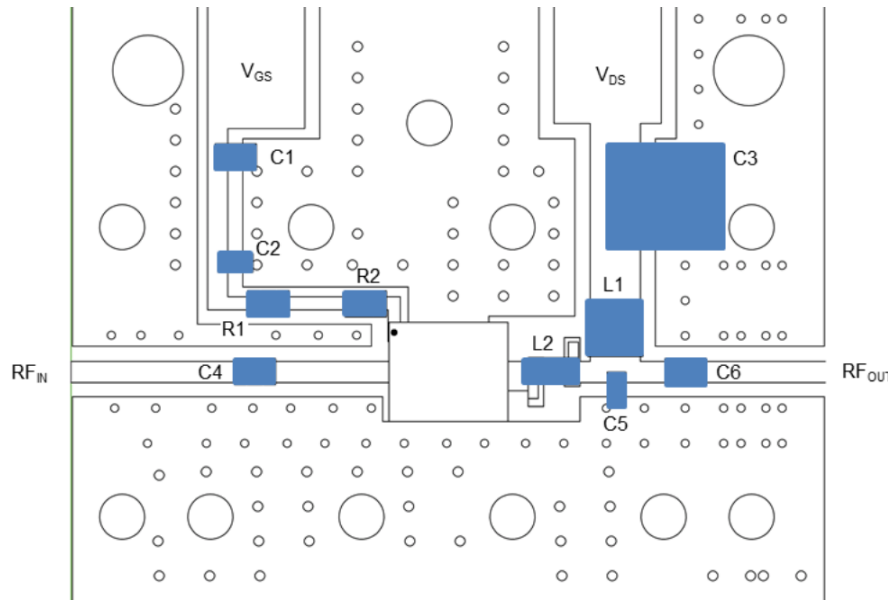
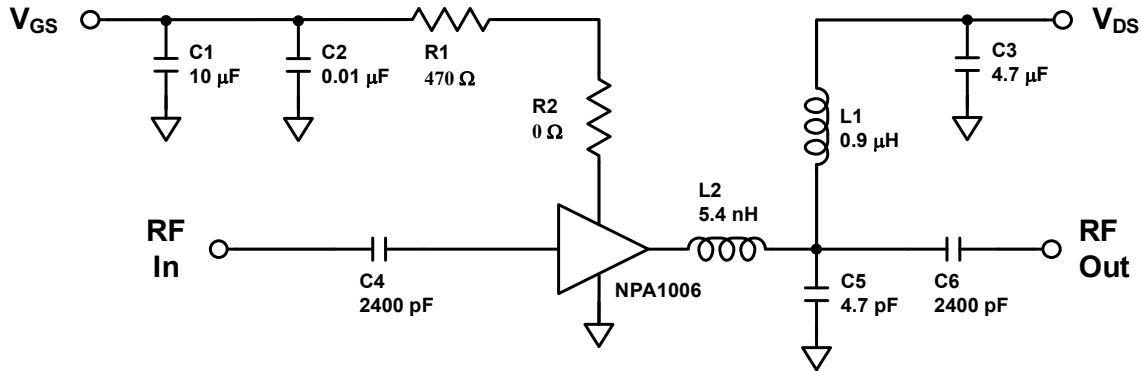

Parts List

Reference	Value	Tolerance	Manufacturer	Part Number
C1	10 µF	20%	TDK	C2012X5R1C106M085AC
C2	0.01 µF	10%	AVX	06031C103JAT2A
C3	4.7 µF	10%	TDK	C5750X7R2A475K230KA
C4, C6	2400 pF	-	Dielectric Labs, Inc.	C08BL242X-5UN-X0
C5	4.7 pF	0.1 pF	Murata	GQM2195C2E4R7BB12
R1	470 Ω	1%	Panasonic	ERJ-3EKF4700V
R2	0 Ω	-	Panasonic	ERJ-6GEY0R00V
L1	0.9 µH	10%	Coilcraft	1008AF-901XJLC
L2	5.4 nH	5%	Coilcraft	0906-5_LB
PCB	Rogers RO4350, $\epsilon_r=3.5$, 0.020"			
Al Heat Sink	Aluminum Heat sink			

GaN Amplifier 28 V, 12.5 W 20 - 1000 MHz



NPA1006

Rev. V5

Typical Performance

Measured in the Broadband 20 - 1000 MHz Sample Board:
CW, $V_{DS} = 28\text{ V}$, $I_{DQ} = 88\text{ mA}$ (unless otherwise noted)

Performance vs. Frequency at $P_{OUT} = P_{SAT}$

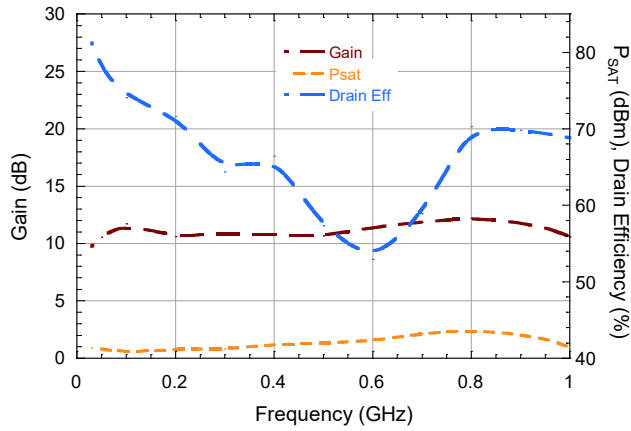

Performance vs. Frequency at $P_{OUT} = 41\text{ dBm}$

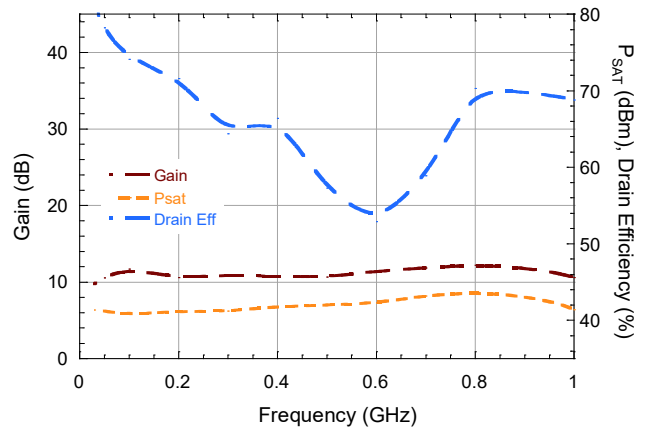

Performance vs. Output Power ($f = 900\text{ MHz}$)

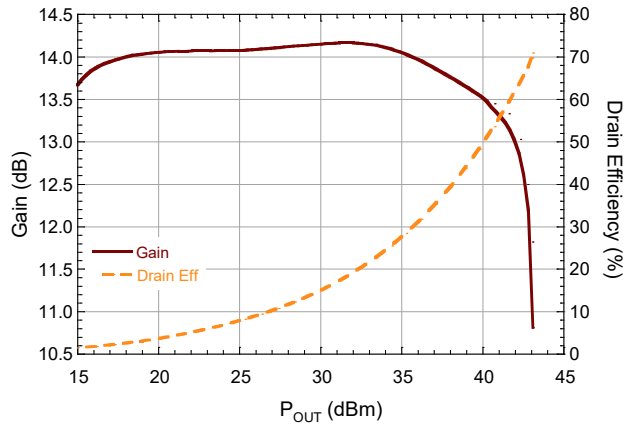

Small Signal S-Parameters vs. Frequency

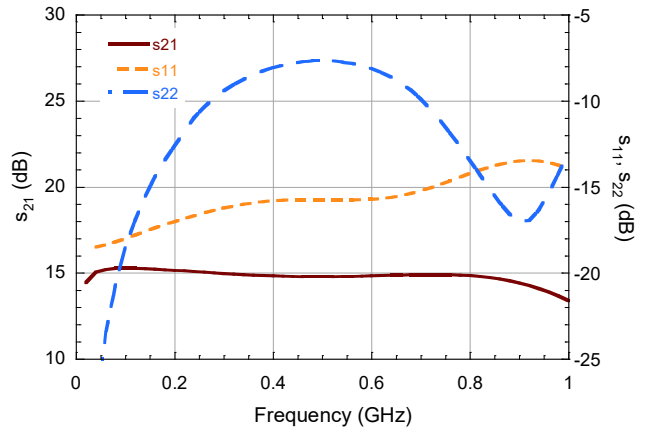

GaN Amplifier 28 V, 12.5 W 20 - 1000 MHz



NPA1006

Rev. V5

Lead-Free 6 x 5 mm 8-Lead PDFN†

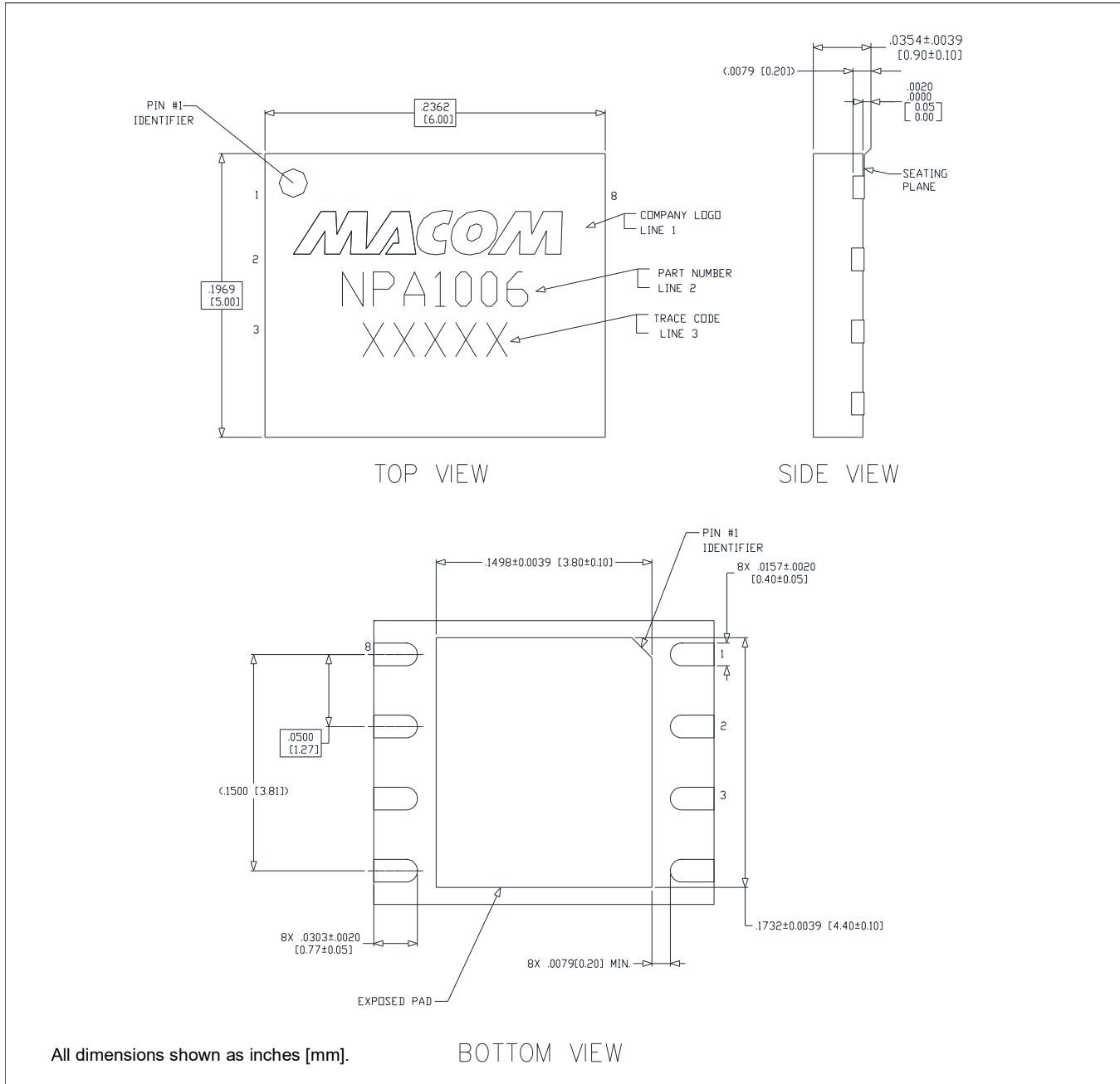

† Reference Application Note S2083 for lead-free solder reflow recommendations.
Meets JEDEC moisture sensitivity level (MSL) 3 requirements.
Plating is NiPdAu.

GaN Amplifier 28 V, 12.5 W 20 - 1000 MHz



NPA1006

Rev. V5

MACOM Technology Solutions Inc. ("MACOM"). All rights reserved.

These materials are provided in connection with MACOM's products as a service to its customers and may be used for informational purposes only. Except as provided in its Terms and Conditions of Sale or any separate agreement, MACOM assumes no liability or responsibility whatsoever, including for (i) errors or omissions in these materials; (ii) failure to update these materials; or (iii) conflicts or incompatibilities arising from future changes to specifications and product descriptions, which MACOM may make at any time, without notice. These materials grant no license, express or implied, to any intellectual property rights.

THESE MATERIALS ARE PROVIDED "AS IS" WITH NO WARRANTY OR LIABILITY, EXPRESS OR IMPLIED, RELATING TO SALE AND/OR USE OF MACOM PRODUCTS INCLUDING FITNESS FOR A PARTICULAR PURPOSE, MERCHANTABILITY, INFRINGEMENT OF INTELLECTUAL PROPERTY RIGHT, ACCURACY OR COMPLETENESS, OR SPECIAL, INDIRECT, INCIDENTAL, OR CONSEQUENTIAL DAMAGES WHICH MAY RESULT FROM USE OF THESE MATERIALS.

MACOM products are not intended for use in medical, lifesaving or life sustaining applications. MACOM customers using or selling MACOM products for use in such applications do so at their own risk and agree to fully indemnify MACOM for any damages resulting from such improper use or sale.

Mouser Electronics

Authorized Distributor

Click to View Pricing, Inventory, Delivery & Lifecycle Information:

[MACOM:](#)

[NPA1006](#)