

# TACT SWITCH DTS(G)-6 SERIES

## 6x6 Through Hole & Ground Terminal Type



### FEATURES

- ※ Compact size 6x6mm
- ※ Sharp tactile feeling
- ※ Cap options

### APPLICATION

- ※ Audio, OA equipment
- ※ Instrumentation
- ※ Industrial

### SPECIFICATION

|                       |   |
|-----------------------|---|
| Contact Rating        | 50mA, 12V DC  |
| Contact Resistance    | 100mΩ max.  |
| Insulation Resistance | 100MΩ min. 500V DC  |
| Dielectric Strength   | 250V AC/1 minute  |
| Operating Force       | 70±30gf, Blue(U)<br>100±50gf, Black(K)<br>160±50gf, Brown(N)<br>260±50gf, Red(R)<br>320±80gf, Salmon(S)<br>520±130gf, Yellow(Y) |
| Travel                | 0.25mm  |
| Operating Life        | Phosphor Bronze Dome<br>50,000 cycles for 520/320gf<br>100,000 cycles for 260gf<br>200,000 cycles for 160/100/70gf              |
|                       | Stainless Steel Dome<br>300,000 cycles for 520/320gf<br>500,000 cycles for 260gf<br>1,000,000 cycles for 160/100/70gf           |
| Operating Temp.       | -25°C ~ +70°C   |
| Storage Temp.         | -30°C ~ +80°C   |

### HOW TO ORDER

**DTS**  - **6**

=Without Ground Pin  
G=With Ground Pin

Height:  
1=4.30mm  
2=5.00mm  
3=7.00mm  
44=7.30mm (SQ.)x2.40mm  
48=7.30mm (SQ.)x2.80mm  
5=9.50mm  
6=13.00mm  
8=11.30mm  
9=19.50mm

Package:  
=Bulk pack  
▲B=Tube  
(▲DTS-61, 62 Only)

V=RoHS & Lead Free Solderable  
Q=Halogen Free

=Phosphor Bronze Dome  
S=Stainless Steel Dome

Operating Force:  
U=Blue, 70gf  
K=Black, 100gf  
N=Brown, 160gf  
R=Red, 260gf  
S=Salmon, 320gf  
Y=Yellow, 520gf

### PACKAGE

<Bag>  
1000 pcs  
<Tub>  
DTS-61/62: 75 pcs

### CIRCUIT



### DTS-6

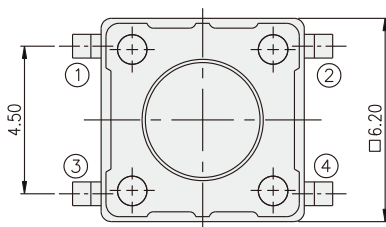

| PART NO. | H     |
|----------|-------|
| DTS-61   | 4.30  |
| DTS-62   | 5.00  |
| DTS-63   | 7.00  |
| DTS-65   | 9.50  |
| DTS-66   | 13.00 |
| DTS-68   | 11.30 |
| DTS-69   | 19.50 |

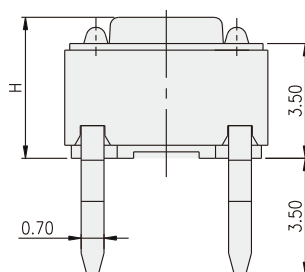
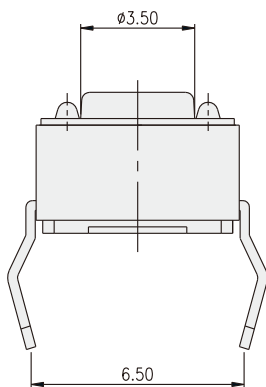

P.C.B. LAYOUT

TACT SWITCH

**DTS-644(8)**

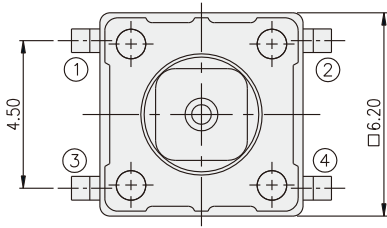

| PART NO. | □A   | □B   |
|----------|------|------|
| DTS-644  | 2.40 | 1.60 |
| DTS-648  | 2.80 | 2.00 |

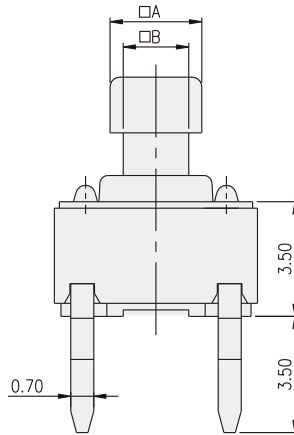
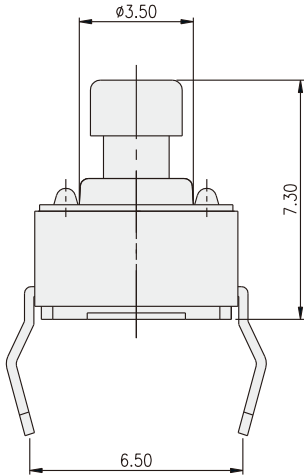

TACT SWITCH

**DTSG-6**

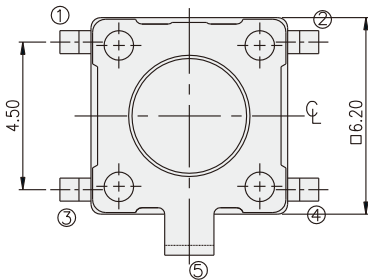

| PART NO. | H     |
|----------|-------|
| DTSG-61  | 4.30  |
| DTSG-62  | 5.00  |
| DTSG-63  | 7.00  |
| DTSG-65  | 9.50  |
| DTSG-66  | 13.00 |
| DTSG-68  | 11.30 |
| DTSG-69  | 19.50 |

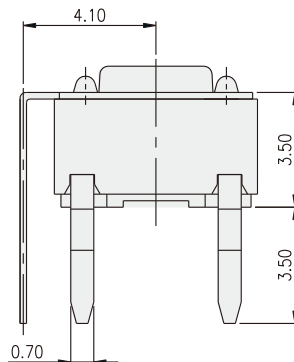
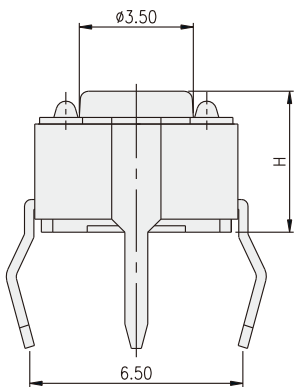

# Mouser Electronics

Authorized Distributor

Click to View Pricing, Inventory, Delivery & Lifecycle Information:

## Diptronics:

[DTS-66Y-V](#) [DTS-61S-V](#) [DTS-644Y-V](#) [DTS-644S-V](#) [DTS-66K-V](#) [DTS-62R-V](#) [DTS-66S-V](#) [DTS-61R-V](#) [DTS-62S-V](#)  
[DTS-65Y-V](#) [DTS-65K-V](#) [DTS-68R-V](#) [DTS-69N-V](#) [DTS-62Y-V](#) [DTS-61Y-V](#) [DTS-65R-V](#) [DTS-61K-V](#) [DTS-63K-V](#)  
[DTS-63R-V](#) [DTS-68N-V](#) [DTS-68K-V](#) [DTS-63Y-V](#) [DTS-66R-V](#) [DTS-63S-V](#) [DTS-644R-V](#) [DTS-65S-V](#) [DTS-62K-V](#)  
[DTS-65N-V](#) [DTS-644K-V](#) [DTS-61N-V](#) [DTS-63N-V](#) [DTS-62N-V](#) [DTS-644N-V](#) [DTS-66N-V](#)