

Bassreflexrohr, ohne Schrauben zu befestigen.

Rohrlänge: 6,5 cm
Einbauöffnung: 35 mm Ø
Öffnungsfläche: 8 cm²

Bass reflex tube which can be mounted without screws.

Tube length: 6,5 cm
Cutout diameter: 35 mm Ø
Surface of opening: 8 cm²

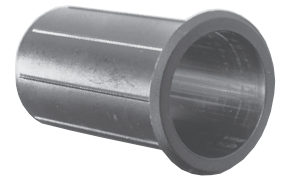
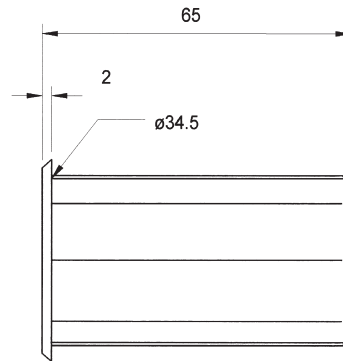
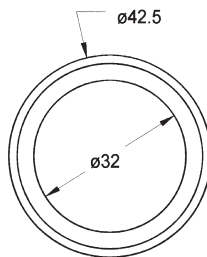

Art. No. 5215 **BR 19.24**

Bassreflexrohr, ohne Schrauben zu befestigen.

Rohrlänge: 19 cm
Einbauöffnung: 63 mm Ø
Öffnungsfläche: 24 cm²

Bass reflex tube which can be mounted without screws.

Tube length: 19 cm
Cutout diameter: 63 mm Ø
Surface of opening: 24 cm²

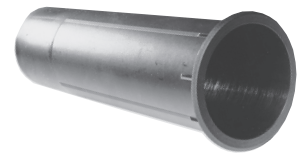
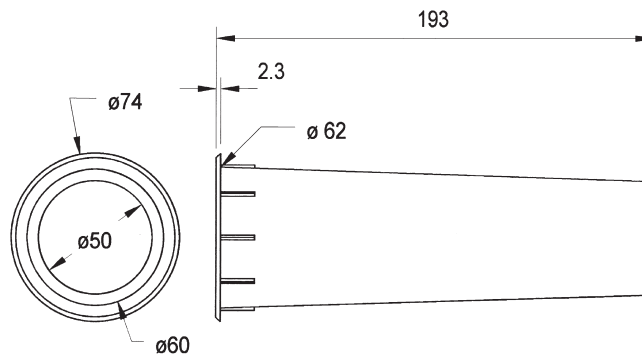

Art. No. 5214 **BR 15.34**

Bassreflexrohr, ohne Schrauben zu befestigen.

Rohrlänge: 14,7 cm
Einbauöffnung: 73 mm Ø
Öffnungsfläche: 34 cm²

Bass reflex tube which can be mounted without screws.

Tube length: 14,7 cm
Cutout diameter: 73 mm Ø
Surface of opening: 34 cm²

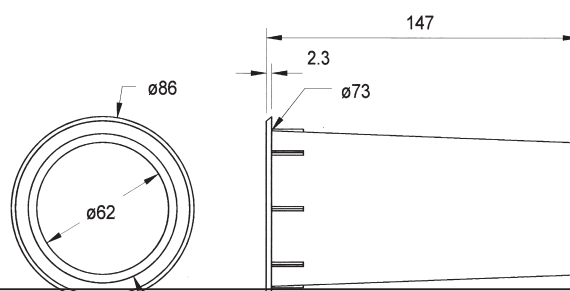



Gekrümmtes Bassreflexrohr mit zwei strömungsgünstigen trompetenförmigen Mündungsöffnungen zur Vermeidung von Luftgeräuschen und Reibungsverlusten.

Rohrlänge: 25 cm (kürzbar bis 20 cm)
 Einbauöffnung: 97 mm Ø
 Öffnungsfläche: 50 cm²
 • Kunststoff: ABS

Bent bass-reflex vent with two flow-resistant optimized trumpet-shaped vent outlets to prevent air-flow noises and friction losses.

Tube length: 25 cm (reducible to 20 cm)
 Cutout diameter: 97 mm Ø
 Surface of opening: 50 cm²
 • Plastic: ABS

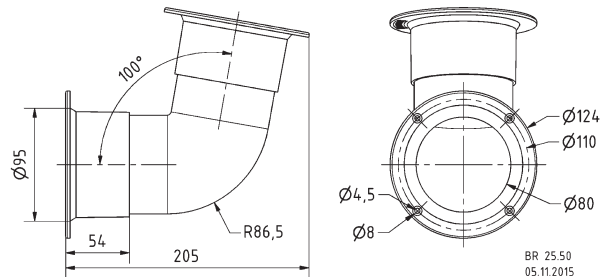

AK 10.13 Art. No. 1020



Abdeckkappe für Mitteltöner, die ein eigenes, abgeschlossenes Volumen benötigen. Passend für Mitteltöner bis 10 cm Durchmesser. Halbrunde Form zur Vermeidung von stehenden Wellen.

Nettovolumen: 0,8 l
 • Kunststoff: PP (P30)

Cover cap for midrange drivers which require an enclosed air volume of their own. Suits any midrange driver with a diameter of up to 10 cm. Half-round shape avoids resonances.

Volume (net): 0,8 l
 • Plastic: PP (P30)

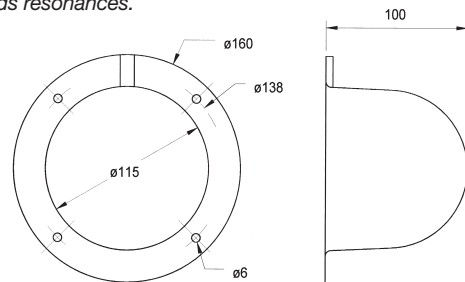

Mouser Electronics

Authorized Distributor

Click to View Pricing, Inventory, Delivery & Lifecycle Information:

[Visaton:](#)

[BR 15.34](#)