

IR2 Single Gas Series Datasheet

Infrared Single Gas Sensor for Mining (Portable and Fixed Systems)

The SGX infrared sensors use the proven Non-Dispersive Infrared (NDIR) principle to detect and monitor the presence of gases. With an infrared source and specific filtering on the pyroelectric detectors mounted inside the optical/gas cavity, individual gases or types of gas can be identified and their concentrations determined.

These sensors are suitable for reliable monitoring of gas levels in mining applications where the sensor size is restricted and require a flameproof enclosure for the hazardous environment.

The IR2xxx Series share the same build and performance standard as the IR1xxx Series, but are labelled as being intrinsically safe for methane monitoring in mining applications.



APPLICATION

- Mining

FEATURES

- For detection of the following gases:
 - Carbon Dioxide (IR21 Series),
 - Hydrocarbons (IR22 series, IR23 series)
- Gas concentration ranges:
 - 0 - 5% Carbon Dioxide (also suitable for 0 to 0.5%v/v)
 - 0 - 100% Carbon Dioxide (also suitable for 0 to 10%)
 - 0 - 100%v/v Hydrocarbons (also suitable for 0 to 100%LEL)
- 16.6mm or 19.0mm sensor heights available
- Embedded temperature sensor in some versions for improved temperature compensation
- Shock-resistant IR Source version available on certain types
- Diffused gas sampling via mesh
- Low power
- Reference channel for self-compensation
- Special gold plated optical gas cavity for stable signal levels
- Operational in varying temperature, pressure and humidity
- Fast response
- Rugged stainless steel construction
- No moving parts
- Immunity from 'poisoning'
- Reliable fail-safe operation
- Certified: ATEX, IECEx

OPERATION

To operate, the sensors must be interfaced to a suitable circuit for power supply, output amplification and signal processing. Sensor outputs require linearisation and compensation for ambient temperature variation using algorithms in the system firmware. This is necessary for sensors to meet their full performance specification. An embedded temperature sensor facilitates this compensation on certain types. Further compensation for pressure changes can also be made in an algorithm, provided there is a suitable input from a pressure sensor.

A set of Application Notes is available from the SGX Sensortech Ltd website, to explain more about NDIR gas sensing and provide advice for the end-user on interfacing the sensors and processing signals.

TECHNICAL SPECIFICATION

Mechanical

| | |
|--------------------|-----------------|
| Dimensions | See Outlines |
| Body material | Stainless Steel |
| Approximate Weight | 30g |

Environmental

| | |
|--|------------------------------|
| Ambient temperature range for operation: | -20°C to +60°C |
| storage: | -20°C to +55°C |
| Operational pressure range | 30kPa to 130kPa |
| Humidity range for operation and storage | 0 to 95% RH (Non-condensing) |

Electrical

| | |
|--------------------------------|--|
| DC supply to detectors | 3V to 5V |
| Typical power | 180mW @ 5V |
| IR Source Supply (Recommended) | +5V, 60mA (Square Wave at 4Hz, 50% duty cycle) |



Whilst SGX has taken care to ensure the accuracy of the information contained herein it accepts no responsibility for the consequences of any use thereof and also reserves the right to change the specification of goods without notice. SGX accepts no liability beyond the set out in its standard conditions of sale in respect of infringement of third party patents arising from the use of SGX products in accordance with information contained herein. In case of modification of the product, SGX disclaims all liability.

CONFIGURATIONS

| Sensor Type ** | Gas | Concentration Range * | | IR Source | | Sensor Height | | Internal Temperature Sensor | | | Qty of Pins |
|----------------|------------------------|-----------------------|--------------|-----------|--------|---------------|------|-----------------------------|------|------|-------------|
| | | Highest | Lowest | Standard | Rugged | 16.6mm | 19mm | Thermistor | LM60 | None | |
| IR21BD | Carbon Dioxide | 0 to 5% | 0 to 0.5% | ✓ | | | ✓ | | | ✓ | 6 |
| IR21EJ | | | | ✓ | | | ✓ | ✓ | | | 7 |
| IR21EM | | | | ✓ | | ✓ | | ✓ | | | 7 |
| IR21GJ | | | | ✓ | | | ✓ | | ✓ | | 7 |
| IR21GM | | | | ✓ | | ✓ | | | ✓ | | 7 |
| IR21BR | | 0 to 100% | 0 to 10% | ✓ | | | ✓ | ✓ | | | 7 |
| IR22BD | Methane / Hydrocarbons | 0 to 100% | 0 to 100%LEL | ✓ | | | ✓ | | | ✓ | 6 |
| IR22BD_1 | | | | | ✓ | | ✓ | | | ✓ | 6 |
| IR22EJ | | | | ✓ | | | ✓ | ✓ | | | 7 |
| IR22EM | | | | ✓ | | ✓ | | ✓ | | | 7 |
| IR22GJ | | | | ✓ | | | ✓ | | ✓ | | 7 |
| IR22GM | | | | ✓ | | ✓ | | | ✓ | | 7 |
| IR23BD | | | | ✓ | | | ✓ | | | | ✓ |

* The Highest Concentration Range is the highest range the sensor is suitable. The Lowest Concentration Range is the lowest range the sensor is suitable. The use of the sensor beyond these ranges will affect the sensor's performance.

** All sensors use temperature compensated pyroelectric detectors except for IR2nBD variants which are uncompensated. This refers to a change in the DC voltage output only. Further temperature compensation is required for all sensor variants.

HANDLING PRECAUTIONS

1. Do not allow sensors to fall on the floor. This could cause IR Source filament breakage, damage to the pins and the gas entrance aperture.
2. Do not apply mechanical force against the gas entrance aperture.
3. Do not immerse sensors in water or other fluids.
4. Protect the gas entrance aperture against dust ingress and sprayed materials.
5. Anti-static handling precautions must be taken.

PERFORMANCE

For test purposes, all data taken using the following conditions:

- Performance as tested in the SGX IR-EK2 Evaluation Kit directly after calibration.
- SGX linearisation and temperature compensation algorithms applied; see Infrared Sensor Application Notes.
- IR Source Voltage 5V, square wave, at 4 Hz and 50% duty cycle. Running the IR Source at 3V will decrease performance due to lower output signals.
- Ambient temperature (20°C) and pressure (101 kPa).
- All gases diluted in dry nitrogen.
- Performance for the Hydrocarbons refers to Methane only. Most other hydrocarbons will have an improved performance.
- Performance data is the same for the supported IR Source variants (“_1” variants).
- Refer to Application Notes for more information.

| Sensor type | IR21BD | IR21xJ, IR21xM | IR21BR | IR22BD | IR22xJ, IR22xM | IR23BD |
|---|---|---|--|---|---|---|
| Gas | Carbon Dioxide | | | Methane / Hydrocarbons ⁽⁵⁾ | | |
| Concentration Range | Refer to Configurations Table | | | | | |
| Warm-up Times | <20 sec to operate <60 sec for Zero ±1% of Full Scale, <30 min to full specification at 20 °C | | | | | |
| Maximum Response Time (T₉₀) ⁽¹⁾ | 20 sec | | | | | |
| Peak-to-Peak Outputs (in N₂) ⁽²⁾ Active (mV): Reference (mV): | 9 to 27 15 to 42 | 12 to 36 9 to 29 | 15 to 50 6 to 22 | 9 to 43 15 to 42 | 22 to 65 9 to 29 | 20 to 60 15 to 42 |
| Sensitivity to Standard Test Gas ^{(2) (3)} Minimum Absorbance: Maximum Absorbance: | 0.25 0.60 | 0.10 0.30 | 0.06 0.12 | 0.07 0.15 | 0.07 0.15 | 0.07 0.15 |
| Typical Sensitivity for Gas Range ⁽³⁾ | Refer to Fractional Absorbance Curves | | | | | |
| Minimum Detection Level ⁽⁴⁾ | 2ppm CO ₂ | 5ppm CO ₂ | 50ppm CO ₂ | 50ppm CH ₄ | 30ppm CH ₄ | 30ppm CH ₄ |
| Maximum deviation from linearity (±) ⁽⁶⁾ 0 to 0.5%v/v Range: 0 to 2%v/v Range: 0 to 2.5%v/v Range: 0 to 5%v/v Range: 0 to 10%v/v Range: 0 to 100%v/v Range: | 0.01%v/v 0.05%v/v ----- 0.10%v/v ----- ----- | 0.02%v/v 0.10%v/v ----- 0.20%v/v ----- ----- | ----- ----- ----- 0.20%v/v 3%v/v | ----- ----- ----- 0.15%v/v ----- 5%v/v | ----- ----- ----- 0.15%v/v ----- 5%v/v | ----- ----- ----- 0.15%v/v ----- 5%v/v |
| Temperature Variation (±ppm/°C) ⁽⁷⁾ Zero and Concentration Range Maximum (-20°C to +55°C) Zero: 0.5%v/v: 2%v/v: 2.5%v/v: 5%v/v: 10%v/v: 100%v/v: | 10 25 100 ----- 250 ----- ----- | 15 30 125 ----- 300 ----- ----- | 10 ----- ----- ----- 500 2500 | 25 ----- ----- ----- 200 ----- 2000 | 25 ----- ----- ----- 200 ----- 2000 | 20 ----- ----- ----- 150 ----- 1500 |
| Short Term Stability (±) ⁽⁸⁾: Zero: 0.5%v/v: 2%v/v: 2.5%v/v: 5%v/v: 10%v/v: 100%v/v: | 5 ppm 0.01%v/v 0.05%v/v ----- 0.10%v/v ----- ----- | 10 ppm 0.01%v/v 0.05%v/v ----- 0.15%v/v ----- ----- | 20 ppm ----- ----- ----- ----- 0.1%v/v 1%v/v | 0.01%v/v ----- ----- ----- 0.08%v/v ----- 2%v/v | 0.01%v/v ----- ----- ----- 0.08%v/v ----- 2%v/v | 0.01%v/v ----- ----- ----- 0.08%v/v ----- 2%v/v |

| Sensor type | IR21BD | IR21xJ, IR21xM | IR21BR | IR22BD | IR22xJ, IR22xM | IR23BD |
|--|---|-------------------|--------|---|---|---|
| Humidity Response (+)⁽⁹⁾ Zero: 0.5%v/v: 2%v/v: 2.5%v/v: 5%v/v: 10%v/v: 100%v/v: | Negligible | | | 0.10%v/v ----- ----- ----- 0.25%v/v ----- 2%v/v | 0.10%v/v ----- ----- ----- 0.25%v/v ----- 2%v/v | 0.15%v/v ----- ----- ----- 0.30%v/v ----- 2%v/v |
| Pressure Effects⁽¹⁰⁾ | Sensors shall meet specification within a $\pm 5\%$ change in ambient pressure from the ambient pressure during calibration | | | | | |
| MTBF (IR Source only) | >10 years for 5 V operation, >20 years for 3 V operation | | | | | |
| Vibration | Conforms to EN 60079-29-1 | | | | | |
| Ingress Protection | Requires extra protection depending on application | | | | | |

- (1) Based upon an immediate step change in concentration at the aperture of the sensor.
- (2) Production Test Limits, using standard test gases of Dry Nitrogen, 2%v/v Carbon Dioxide and 5%v/v Methane, where appropriate.
- (3) A 0.30 absorbance is equivalent to a 30% decrease in the Active peak-to-peak output.
- (4) The minimum detection level is the smallest detectable change in concentration based upon a 2 sigma variation. The best detectable change occurs at 0% gas concentration due to the non-linear output of the detector (see Fractional Absorbance Curves).
- (5) The sensors are cross-sensitive to most hydrocarbons. The sensors have a higher sensitivity to most hydrocarbons compared to methane.
- (6) After linearisation using the recommended method of linearisation and based upon a calibration gas with a concentration >75% of the full-scale.
- (7) Using average Alpha and Beta coefficients based upon test data from the instrument in which the sensor is being tested. Refer to Application Notes for information on calculating Alpha and Beta coefficients. Accuracy can be improved by measuring each sensor over temperature to define specific Alpha or Alpha & Beta coefficients.
- (8) After sensor stabilisation and over a period of 8 hours.
- (9) Difference in response when changed from 0 %RH to 90 %RH.
- (10) Sensors can be used over a greater ambient pressure using pressure compensation of the concentration. An external pressure sensor will be required for this.

FRACTIONAL ABSORBANCE CURVES

These show the typical sensitivity versus concentration before linearisation for the range of gases. For further explanation, refer to the Infrared Sensor Application Notes.

Primary Target Gases

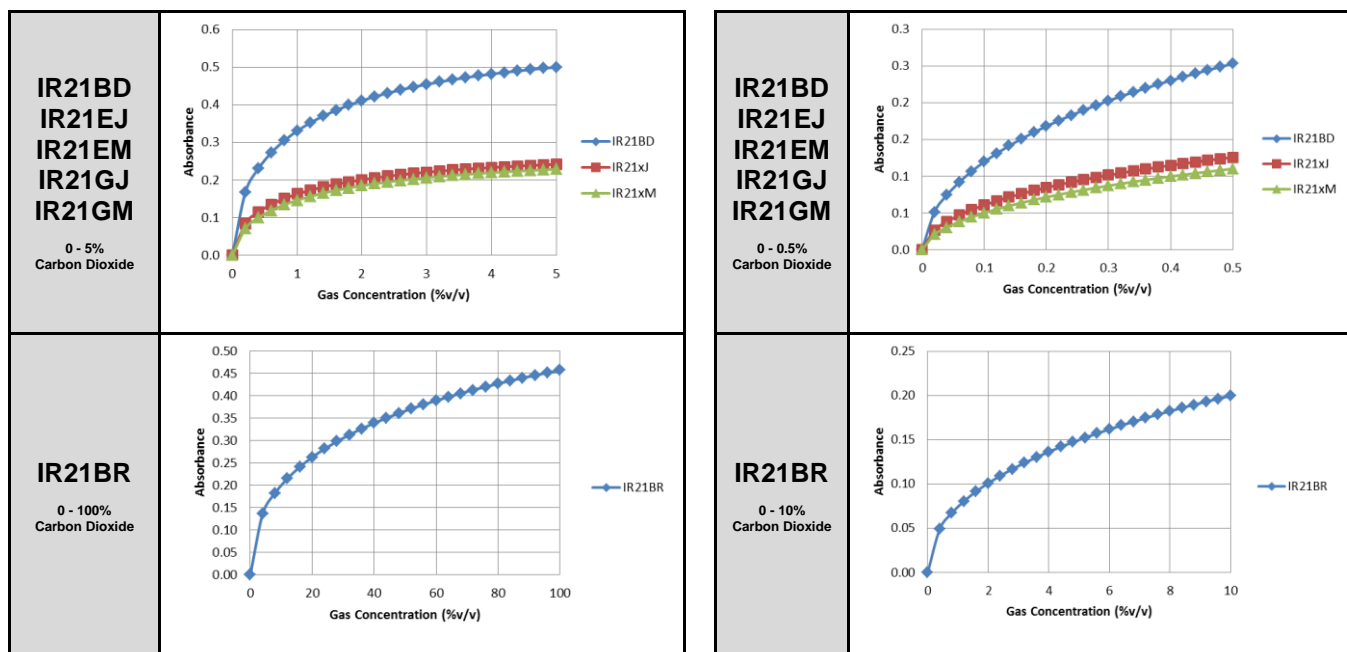

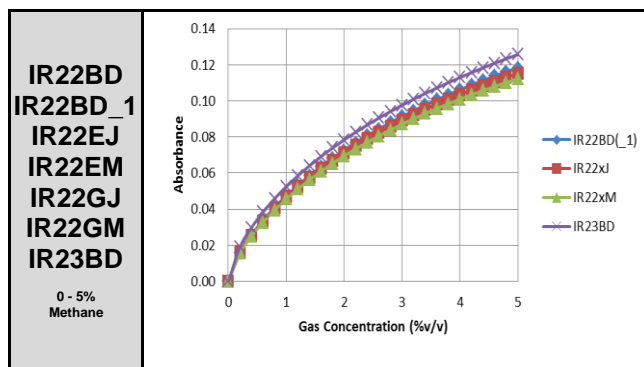
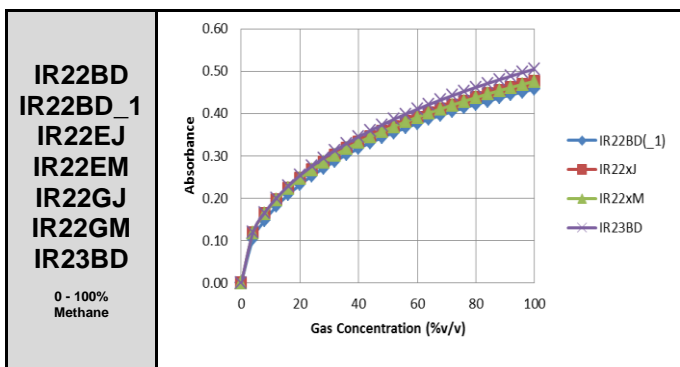

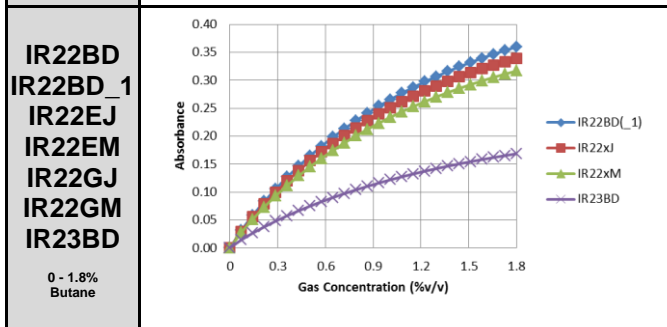
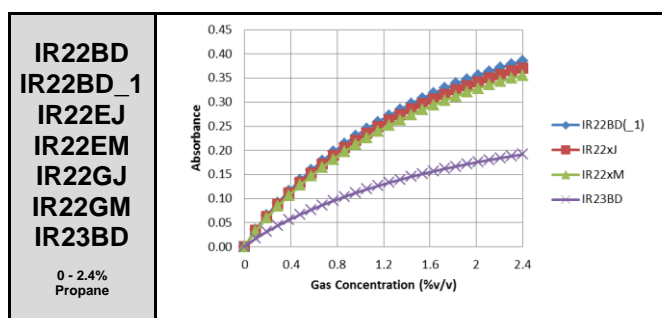
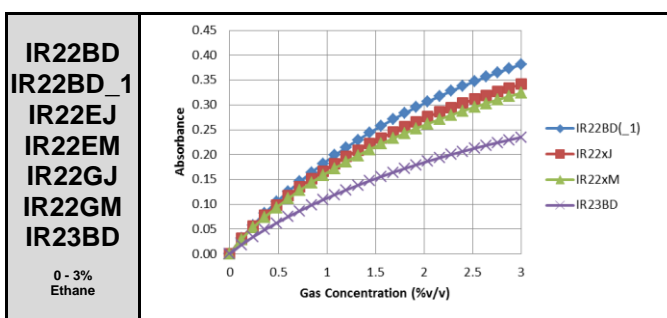

Other Target Gases



CERTIFICATIONS

| | | | |
|--|--|--|-------------------|
|   | Certificate Numbers: | ATEX: Sira 02ATEX2015U IECEX: IECEX SIR 03.0003U | |
| | Issued by: | Sira Test & Certification Service Rake Lane Eccleston Chester, CH4 9JN, UK | |
| | Have been assessed to the following harmonized standards: | EN 60079-0:2012 & IEC 60079-0:2011 (Ed. 6) Electrical apparatus for explosive gas atmospheres – General requirements EN 60079-11:2012 & IEC 60079-11:2011 (Ed. 6) Explosive atmospheres. Equipment protection by intrinsic safety "i" | |
| | Product Marking: | ATEX: I M1 Ex ia I Ma IECEX: Ex ia I Ma | Ta -20°C to +60°C |

INSTRUCTIONS SPECIFIC TO HAZARDOUS AREA INSTALLATIONS

(Ref: EU ATEX Directive 2014/34/EU)

- The IR2xxx Series Gas Sensing Heads are component-approved only and may not be used as stand-alone items in a hazardous area without further protection.
- The IR2xxx Series Gas Sensing Heads shall be protected in service. The Sensing Head shall be mounted in a protective enclosure such that an impact of 7 J in accordance with IEC 60079-0:2007 clause 26.4.2 from any direction shall not cause the impact head to make contact with the Sensing Head.
- The thermal resistance the IR2xxx Series Gas Sensing Head does not exceed 25 K/W; this shall be taken into account when considering its surface temperature and the temperature classification of the equipment into which it is to be incorporated.
- The IR2xxx Series Gas Sensing Heads have not been assessed as a safety device (EHSR 1.5).
- There are no user-serviceable parts in the component.
- The end-user/installer shall be aware that the certification of the IR2xxx Series Gas Sensing Heads relies on the following materials used in its construction, which are suitable for most common applications:
 - Enclosure..... Stainless steel
 - Mesh..... Stainless steel
 - Bushing..... Epoxy resin

In accordance with the Note in EN60079-0:2006 clause 6.1, the end-user/installer shall inform the manufacturer of any adverse conditions that the IR2xxx Series Gas Sensing Heads may encounter. This is to ensure that the IR2xxx Series Gas Sensing Heads are not subjected to conditions that may cause degradation of these materials.

- The IR2xxx Series Gas Sensing Head is only certified for use in ambient temperatures between -20°C and +60°C and should not be used outside this range.
- The IR2xxx Series products shall be installed/used in accordance with the following restrictions:

| | |
|-------------------------|-------------------------|
| Lamp Circuit | U _i = 7.2 V |
| Detector Circuit | U _i = 10 V |
| Lamp + Detector Circuit | P _i = 2.71 W |
| Detector Circuit | P _i = 1.2 W |

- The IR2xxx Series Gas Sensing Heads are dust-proof (IP5x) but offers no protection against the ingress of water. Where protection in excess of IP50 is required, the apparatus into which the IR2xxx Series Head is installed shall provide the necessary ingress protection (for example by fitting an external semi-permeable membrane).

OUTLINE

(All dimensions in millimetres; dimensions without limits are nominal)

6-Pin Devices (See Configuration Table)

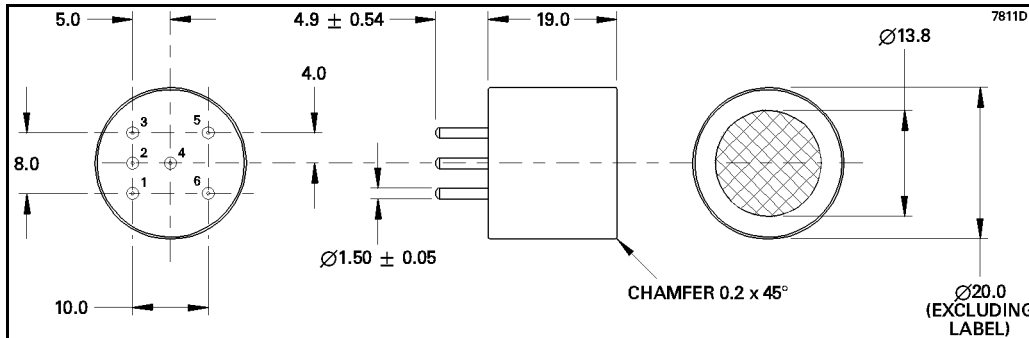

7-Pin Devices (See Configuration Table)

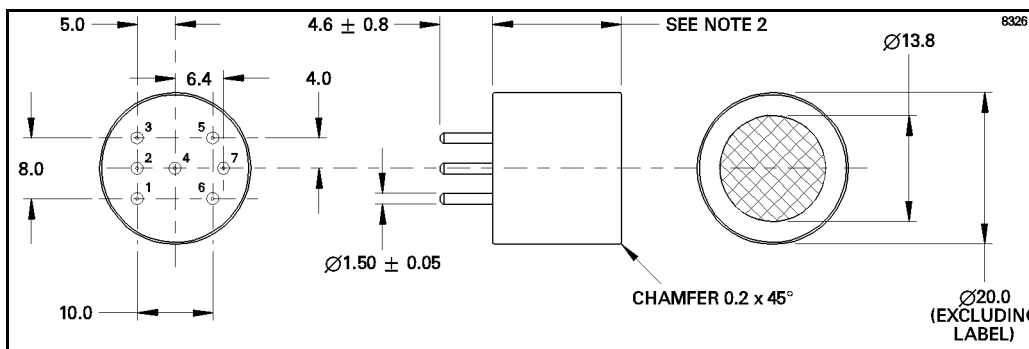

Connections

| Pin | Connection |
|-----|---|
| 1 | +V DC detector input |
| 2 | IR Source |
| 3 | IR Source return |
| 4 | Active detector output |
| 5 | Reference detector output |
| 6 | 0 V input |
| 7 | Temperature sensor: Thermistor (code E); LM60 (code G) (7-Pin Devices Only) |

Outline Notes

1. Body dimensional tolerances ± 0.1 mm. Pin dimensional tolerances as indicated.
2. For code J devices, this length is 19.0 mm; for code M devices it is 16.6 mm.
3. IR2xxx Series sensors are designed to press-fit into PCB sockets. The end-user should choose a socket to accommodate the full sensor pin length. This will ensure a stable mechanical location as well as good electrical contact. SGX Sensortech Ltd recommend the Wearn's Cambion type 450-1813-01-03-00 single-pole solder mount socket with through hole, or a suitable equivalent.

ACCESSORIES

Dust Membrane (DPP702964BA)

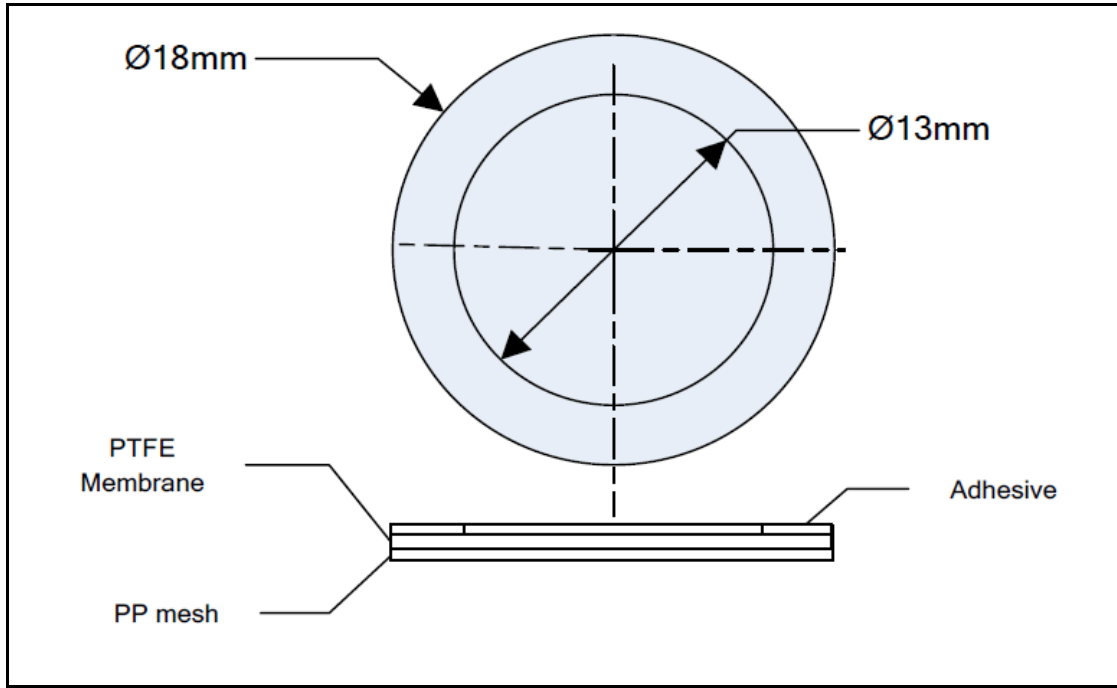

| | |
|---------------------------------|---|
| Material | PTFE |
| Air Flow | $\geq 6.8 \text{ l/hr/cm}^2$ (Δp 10mbar) |
| Water Intrusion Pressure | $\geq 210 \text{ mbar}$ |
| Laminated PTFE Thickness | 0.28 mm (nominal) |
| Adhesive Thickness | 0.19 mm (nominal) |
| Typical Pore Size | 5 μm |

Mouser Electronics

Authorized Distributor

Click to View Pricing, Inventory, Delivery & Lifecycle Information:

[Amphenol:](#)

[IR22BD](#)