

## POWER MOS 7® MOSFET

Power MOS 7® is a new generation of low loss, high voltage, N-Channel enhancement mode power MOSFETS. Both conduction and switching losses are addressed with Power MOS 7® by significantly lowering  $R_{DS(ON)}$  and  $Q_g$ . Power MOS 7® combines lower conduction and switching losses along with exceptionally fast switching speeds inherent with APT's patented metal gate structure.

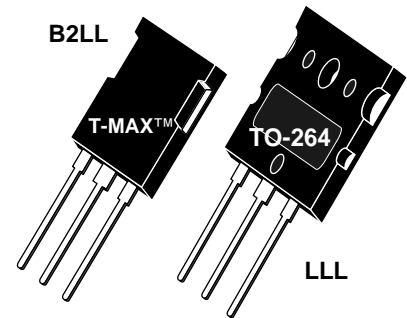

- Lower Input Capacitance
- Lower Miller Capacitance
- Lower Gate Charge,  $Q_g$
- Increased Power Dissipation
- Easier To Drive
- Popular T-MAX™ or TO-264 Package

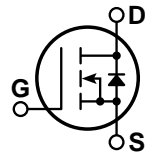

### MAXIMUM RATINGS

All Ratings:  $T_C = 25^\circ\text{C}$  unless otherwise specified.

Symbol	Parameter	APT12057(G)	UNIT
$V_{DSS}$	Drain-Source Voltage	1200	Volts
$I_D$	Continuous Drain Current @ $T_C = 25^\circ\text{C}$	22	Amps
$I_{DM}$	Pulsed Drain Current <sup>①</sup>	88	
$V_{GS}$	Gate-Source Voltage Continuous	$\pm 30$	Volts
$V_{GSM}$	Gate-Source Voltage Transient	$\pm 40$	
$P_D$	Total Power Dissipation @ $T_C = 25^\circ\text{C}$	690	Watts
	Linear Derating Factor	5.52	W/ $^\circ\text{C}$
$T_J, T_{STG}$	Operating and Storage Junction Temperature Range	-55 to 150	$^\circ\text{C}$
$T_L$	Lead Temperature: 0.063" from Case for 10 Sec.	300	
$I_{AR}$	Avalanche Current <sup>①</sup> (Repetitive and Non-Repetitive)	22	Amps
$E_{AR}$	Repetitive Avalanche Energy <sup>①</sup>	50	mJ
$E_{AS}$	Single Pulse Avalanche Energy <sup>④</sup>	3000	

### STATIC ELECTRICAL CHARACTERISTICS

Symbol	Characteristic / Test Conditions	MIN	TYP	MAX	UNIT
$BV_{DSS}$	Drain-Source Breakdown Voltage ( $V_{GS} = 0V, I_D = 250\mu\text{A}$ )	1200			Volts
$I_{D(on)}$	On State Drain Current <sup>②</sup> ( $V_{DS} > I_{D(on)} \times R_{DS(on)}$ Max, $V_{GS} = 10V$ )	22			Amps
$R_{DS(on)}$	Drain-Source On-State Resistance <sup>②</sup> ( $V_{GS} = 10V, 0.5 I_{D(Cont.)}$ )			0.570	Ohms
$I_{DSS}$	Zero Gate Voltage Drain Current ( $V_{DS} = V_{DSS}, V_{GS} = 0V$ )			100	$\mu\text{A}$
	Zero Gate Voltage Drain Current ( $V_{DS} = 0.8 V_{DSS}, V_{GS} = 0V, T_C = 125^\circ\text{C}$ )			500	
$I_{GSS}$	Gate-Source Leakage Current ( $V_{GS} = \pm 30V, V_{DS} = 0V$ )			$\pm 100$	nA
$V_{GS(th)}$	Gate Threshold Voltage ( $V_{DS} = V_{GS}, I_D = 2.5\text{mA}$ )	3		5	Volts

 **CAUTION:** These Devices are Sensitive to Electrostatic Discharge. Proper Handling Procedures Should Be Followed.

Symbol	Characteristic	Test Conditions	MIN	TYP	MAX	UNIT
$C_{iss}$	Input Capacitance	$V_{GS} = 0V$ $V_{DS} = 25V$ $f = 1 \text{ MHz}$		5155	6200	pF
$C_{oss}$	Output Capacitance			770	1080	
$C_{rss}$	Reverse Transfer Capacitance			130	200	
$Q_g$	Total Gate Charge <sup>③</sup>	$V_{GS} = 10V$ $V_{DD} = 0.5 V_{DSS}$ $I_D = I_{D[Cont.]} @ 25^\circ C$		187	290	nC
$Q_{gs}$	Gate-Source Charge			24	29	
$Q_{gd}$	Gate-Drain ("Miller") Charge			120	180	
$t_{d(on)}$	Turn-on Delay Time	$V_{GS} = 15V$ $V_{DD} = 0.5 V_{DSS}$ $I_D = I_{D[Cont.]} @ 25^\circ C$ $R_G = 0.6\Omega$		11	22	ns
$t_r$	Rise Time			20	40	
$t_{d(off)}$	Turn-off Delay Time			36	54	
$t_f$	Fall Time			21	30	

SOURCE-DRAIN DIODE RATINGS AND CHARACTERISTICS

Symbol	Characteristic / Test Conditions	MIN	TYP	MAX	UNIT
$I_S$	Continuous Source Current (Body Diode)			22	Amps
$I_{SM}$	Pulsed Source Current <sup>①</sup> (Body Diode)			88	
$V_{SD}$	Diode Forward Voltage <sup>②</sup> ( $V_{GS} = 0V, I_S = -I_{D[Cont.]}$ )			1.3	Volts
$t_{rr}$	Reverse Recovery Time ( $I_S = -I_{D[Cont.]}, di_S/dt = 100A/\mu s$ )		1291		ns
$Q_{rr}$	Reverse Recovery Charge ( $I_S = -I_{D[Cont.]}, di_S/dt = 100A/\mu s$ )		29		$\mu C$
$dv/dt$	Peak Diode Recovery $dv/dt$ <sup>⑤</sup>			10	V/ns

THERMAL CHARACTERISTICS

Symbol	Characteristic	MIN	TYP	MAX	UNIT
$R_{\theta JC}$	Junction to Case			0.18	$^\circ C/W$
$R_{\theta JA}$	Junction to Ambient			40	

- ① Repetitive Rating: Pulse width limited by maximum junction temperature.
- ② Pulse Test: Pulse width < 380  $\mu s$ , Duty Cycle < 2%

- ③ See MIL-STD-750 Method 3471
- ④ Starting  $T_j = +25^\circ C$ ,  $L = 12.40mH$ ,  $R_G = 25\Omega$ , Peak  $I_L = 22A$
- ⑤  $dv/dt$  numbers reflect the limitations of the test circuit rather than the device itself.  $I_S \leq -I_{D[Cont.]}$ ,  $di/dt \leq 700A/\mu s$ ,  $V_R \leq V_{DSS}$ ,  $T_J \leq 150^\circ C$

APT Reserves the right to change, without notice, the specifications and information contained herein.

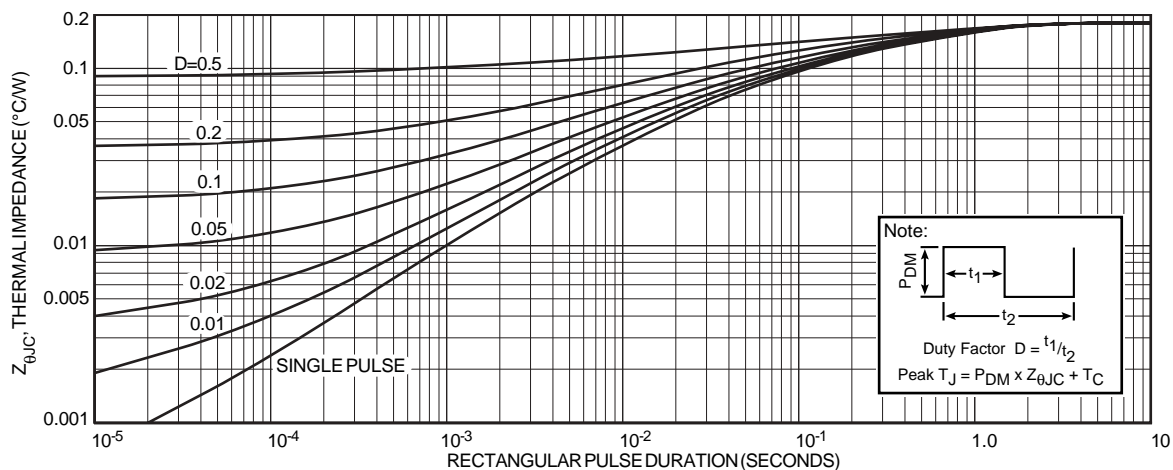

FIGURE 1, MAXIMUM EFFECTIVE TRANSIENT THERMAL IMPEDANCE, JUNCTION-TO-CASE vs PULSE DURATION

Graph Deleted

FIGURE 2, HIGH VOLTAGE OUTPUT CHARACTERISTICS

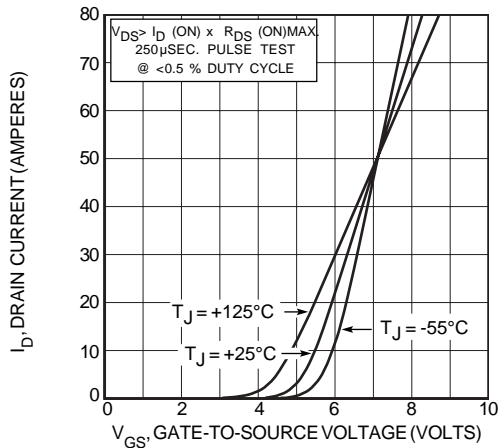

FIGURE 4, TRANSFER CHARACTERISTICS

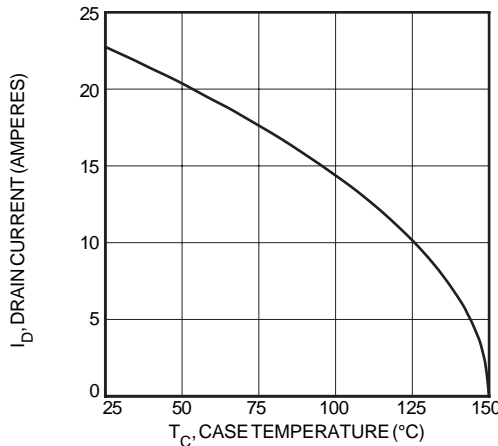

FIGURE 6, MAXIMUM DRAIN CURRENT vs CASE TEMPERATURE

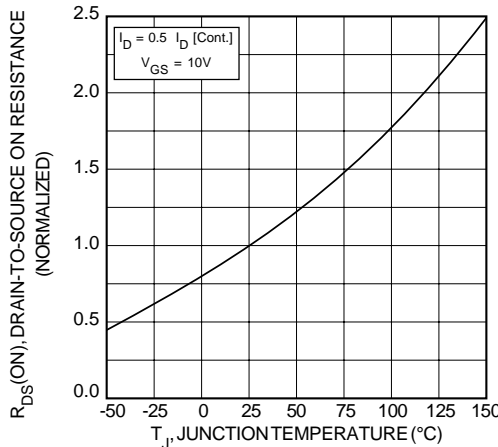

FIGURE 8, ON-RESISTANCE vs. TEMPERATURE

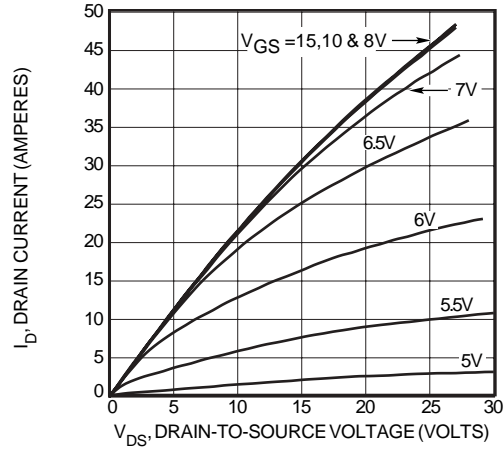

FIGURE 3, LOW VOLTAGE OUTPUT CHARACTERISTICS

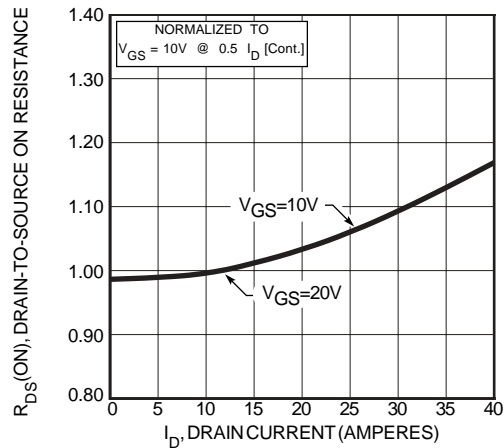

FIGURE 5,  $R_{DS(ON)}$  vs DRAIN CURRENT

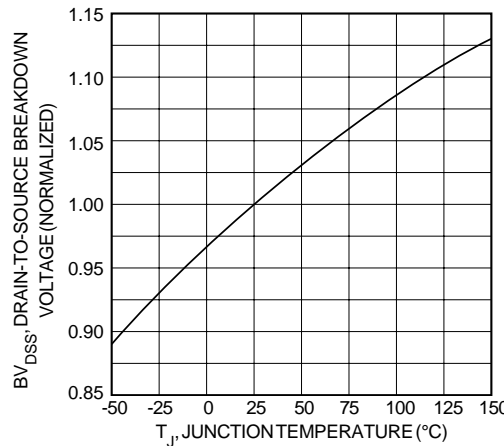

FIGURE 7, BREAKDOWN VOLTAGE vs TEMPERATURE

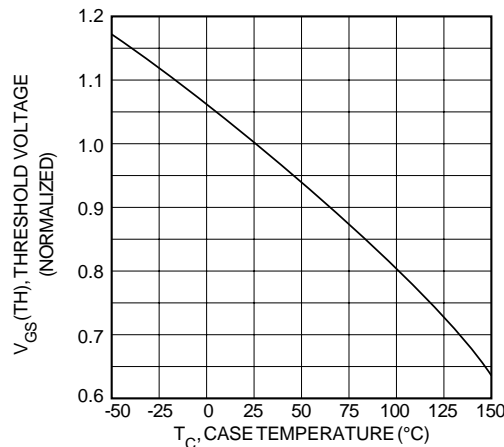

FIGURE 9, THRESHOLD VOLTAGE vs TEMPERATURE

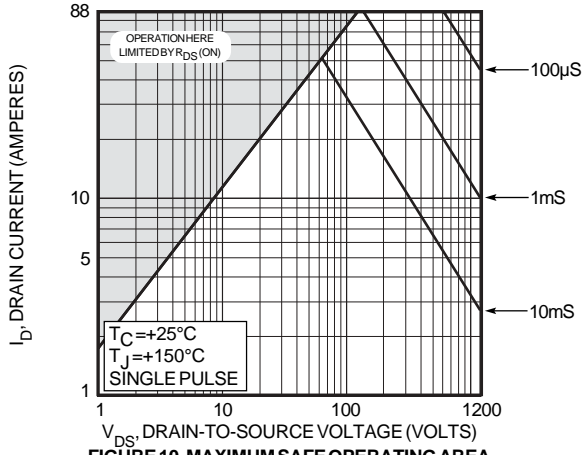

FIGURE 10, MAXIMUM SAFE OPERATING AREA

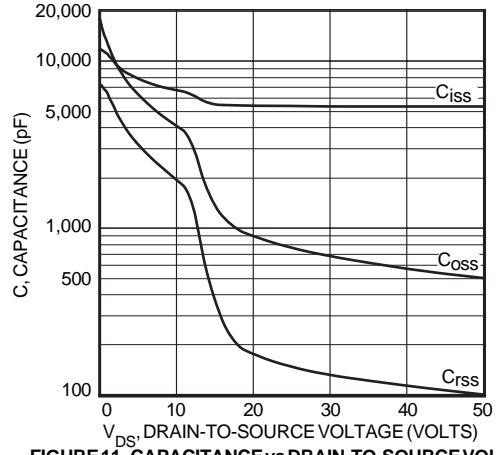

FIGURE 11, CAPACITANCE vs DRAIN-TO-SOURCE VOLTAGE

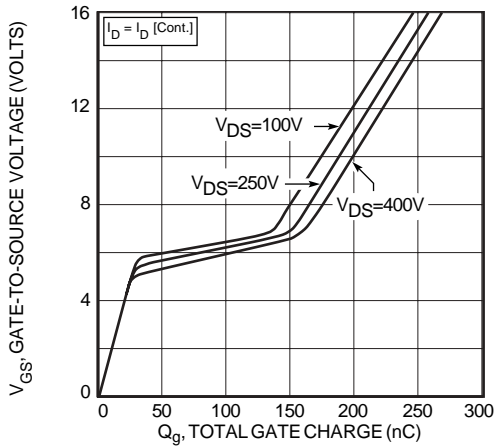

FIGURE 12, GATE CHARGES vs GATE-TO-SOURCE VOLTAGE

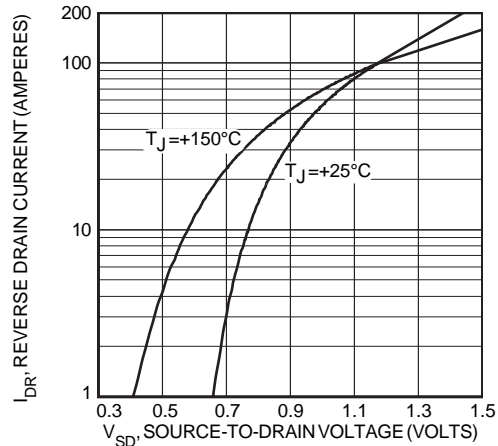
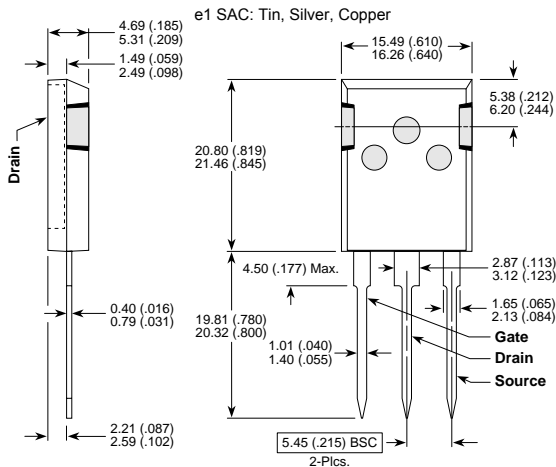

FIGURE 13, SOURCE-DRAIN DIODE FORWARD VOLTAGE

T-MAX™ (B2) Package Outline



These dimensions are equal to the TO-247 without the mounting hole.  
Dimensions in Millimeters and (Inches)

TO-264 (L) Package Outline

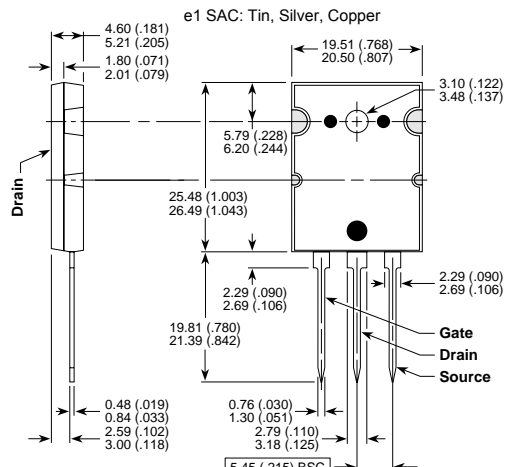

Dimensions in Millimeters and (Inches)

# Mouser Electronics

Authorized Distributor

Click to View Pricing, Inventory, Delivery & Lifecycle Information:

[Microchip:](#)

[APT12067B2LLG](#) [APT12057B2LLG](#)