

**Description: MiMo LTE, MiMo WiFi, GNSS
Vehicle Mount Antenna**

Series: Panther

**PART NUMBER: GPSMB501, GPSMB502, GPSMB501R,
GPSMB502R**



Features:

- Supports MIMO Cellular LTE 698-960/1695-2170/2300-2700/2900-3600MHz
- Supports MIMO WiFi and DSRC 2400-2500MHz/4900-5925MHz
- Supports Beidou, GPS, Galileo, GLONASS
- Direct Mount and optional Magnetic Mount features
- See GPSMBMM for magnetic mount details

Applications:

- Telematics
- Location based services
- First Responders(Police, Ambulance, Fire)
- Government
- Energy(Utility Vehicles)
- Fleet Management
- Railroad



All dimensions are in mm / inches

Issue: 1823

In the effort to improve our products, we reserve the right to make changes judged to be necessary.

CONFIDENTIAL AND PROPRIETARY INFORMATION

This document contains confidential and proprietary information of Pulse Electronics, Inc. (Pulse) and is protected by copyright, trade secret and other state and federal laws. Its receipt or possession does not convey any rights to reproduce, disclose its contents, or to manufacture, use or sell anything it may describe. Reproduction, disclosure or use without specific written authorization of Pulse is strictly forbidden.

For more information:

Pulse Worldwide Headquarters
12220 World Trade Drive
San Diego, CA 92128
USA
Tel:1-858-674-8100

Pulse/Larsen Antennas
18110 SE 34th St Bldg 2 Suite 250
Vancouver, WA 98683
USA
Tel: 1-360-944-7551

Europe Headquarters
Pulse GmbH & Do, KG
Zeppelinstrasse 15
Herrenberg, Germany
Tel: 49 7032 7806 0

Pulse (Suzhou) Wireless Products Co, Inc.
99 Huo Ju Road(#29 Bldg,4th Phase
Suzhou New District
Jiangsu Province, Suzhou 215009 PR China
Tel: 86 512 6807 9998



**Description: MiMo LTE, MiMo WiFi, GNSS
Vehicle Mount Antenna**

Series: Panther

**PART NUMBER: GPSMB501, GPSMB502, GPSMB501R,
GPSMB502R**

This document covers all product variants of the following product family

Model No.	Color	Remark
GPSMB501	Black	
GPSMB502	White	
GPSMB501R	Black	Compliant with EN 50155, EN 61373, EN45545-2, railroad application.
GPSMB502R	White	Compliant with EN 50155, EN 61373, EN45545-2, railroad application.

Issue: 1823

In the effort to improve our products, we reserve the right to make changes judged to be necessary.

CONFIDENTIAL AND PROPRIETARY INFORMATION

This document contains confidential and proprietary information of Pulse Electronics, Inc. (Pulse) and is protected by copyright, trade secret and other state and federal laws. Its receipt or possession does not convey any rights to reproduce, disclose its contents, or to manufacture, use or sell anything it may describe. Reproduction, disclosure or use without specific written authorization of Pulse is strictly forbidden.

For more information:

Pulse Worldwide Headquarters
12220 World Trade Drive
San Diego, CA 92128
USA
Tel: 1-858-674-8100

Pulse/Larsen Antennas
18110 SE 34th St Bldg 2 Suite 250
Vancouver, WA 98683
USA
Tel: 1-360-944-7551

Europe Headquarters
Pulse GmbH & Do, KG
Zeppelinstrasse 15
Herrenberg, Germany
Tel: 49 7032 7806 0

Pulse (Suzhou) Wireless Products Co, Inc.
99 Huo Ju Road(#29 Bldg,4th Phase
Suzhou New District
Jiangsu Province, Suzhou 215009 PR China
Tel: 86 512 6807 9998



**Description: MiMo LTE, MiMo WiFi, GNSS
Vehicle Mount Antenna**

Series: Panther

**PART NUMBER: GPSMB501, GPSMB502, GPSMB501R,
GPSMB502R**

ELECTRICAL SPECIFICATIONS

Frequency (LTE)	698 - 960 / 1695 – 2170 / 2300 - 2700 / 2900 – 3600	MHz
Frequency (WiFi&DSRC)	2400 – 2500/ 4900 – 5925	MHz
Frequency (Beidou, GPS, Galileo, Glonass)	1561.098±2.046/ 1575.42±1.023/ 1602.5625±4	MHz
Nominal Impedance	50	Ω
VSWR (LTE)	< 1.5	
VSWR (WiFi&DSRC)	< 1.4	
Gain* (LTE antenna, < 2170 MHz)	4	dBi ± 2.5 dB
Gain* (LTE antenna, > 2170 MHz)	5	dBi ± 2 dB
Gain* (WiFi antenna, < 2500 MHz)	4.5	dBi ± 1.5 dB
Gain* (WiFi antenna, > 4900 MHz)	5	dBi ± 2 dB
Isolation LTE to LTE **	15 or better	dB
Isolation WiFi to WiFi **	40 or better	dB
GNSS antenna RHCP gain	1	dBic ± 2 dB
LNA gain	30	dB ± 2 dB
Noise Figure	2.5 (cascade)	dB
Current	8	mA ± 2 mA
V _{dc}	3-5	V _{dc}
LNA and filter attenuation		
	@ 824 MHz	70 dB
	@ 960 MHz	65 dB
	@ 1710 MHz	60 dB
	@ 2170 MHz	65 dB

*Measured on 2ft GND plane and with 4 inch cables

**In free space with 17ft cables

Issue: 1823

In the effort to improve our products, we reserve the right to make changes judged to be necessary.

CONFIDENTIAL AND PROPRIETARY INFORMATION

This document contains confidential and proprietary information of Pulse Electronics, Inc. (Pulse) and is protected by copyright, trade secret and other state and federal laws. Its receipt or possession does not convey any rights to reproduce, disclose its contents, or to manufacture, use or sell anything it may describe. Reproduction, disclosure or use without specific written authorization of Pulse is strictly forbidden.

**Description: MiMo LTE, MiMo WiFi, GNSS
Vehicle Mount Antenna**

**PART NUMBER: GPSMB501, GPSMB502, GPSMB501R,
GPSMB502R**

Series: Panther

ELECTRICAL SPECIFICATIONS

Connector type(s)	SMA (LTE and GPS) / SMA-RP (WiFi)
Cable type(s)	RG-58 (LTE and WiFi) / RG-174 (GPS)
Length	17 FEET

Issue: 1823

In the effort to improve our products, we reserve the right to make changes judged to be necessary.

CONFIDENTIAL AND PROPRIETARY INFORMATION

This document contains confidential and proprietary information of Pulse Electronics, Inc. (Pulse) and is protected by copyright, trade secret and other state and federal laws. Its receipt or possession does not convey any rights to reproduce, disclose its contents, or to manufacture, use or sell anything it may describe. Reproduction, disclosure or use without specific written authorization of Pulse is strictly forbidden.

**Description: MiMo LTE, MiMo WiFi, GNSS
Vehicle Mount Antenna**

Series: Panther

**PART NUMBER: GPSMB501, GPSMB502, GPSMB501R,
GPSMB502R**

MECHANICAL SPECIFICATIONS

Plastic radome for GPSMB501/GPSMB502	ABS/PC Material UV Stabilized, UL-94HB
for GPSMB501R/GPSMB502R	PC material, EN45545 R6 HL3 compliant
Color	Black, White
Ingress Protection	IP67
Weight	~1340 g
Fixing system	Roof mounting (Also Magnet mounting accessory available, GPSMBMM) Recommended fastening torque 1518ft-lb (20-25Nm).

ENVIRONMENTAL SPECIFICATIONS

Operating temperature	MIL-STD 810G -40/+85° C
Humidity	95%RH @ +25°C for 12h and 55°C for 12h
Vibration	MIL-STD 810G, section 514.6 , 5-500 Hz, 60min/axis
Thermal Shocks	MIL-STD 810G, section 503.5, -40 to +85°C, 3 cycles
Drop Test	Minimum of one drop per axis – 4, 1 meter drops

Issue: 1823

In the effort to improve our products, we reserve the right to make changes judged to be necessary.

CONFIDENTIAL AND PROPRIETARY INFORMATION

This document contains confidential and proprietary information of Pulse Electronics, Inc. (Pulse) and is protected by copyright, trade secret and other state and federal laws. Its receipt or possession does not convey any rights to reproduce, disclose its contents, or to manufacture, use or sell anything it may describe. Reproduction, disclosure or use without specific written authorization of Pulse is strictly forbidden.

**Description: MiMo LTE, MiMo WiFi, GNSS
Vehicle Mount Antenna**

Series: Panther

**PART NUMBER: GPSMB501, GPSMB502, GPSMB501R,
GPSMB502R**

Tests for railroad certification per EN50155, EN61373, EN45545-2

NO	T SN IN STAND	TEST DESCRIPTION	REFER STANDARD	TEST REPORT NO	RESULT(PASS/FAIL)
1	12.2.3	Cooling test	EN 50155	DD20170919002	PASS
2	12.2.4	Dry heat test			
3	12.2.5	Damp heat test, cyclic			
4	12.2.6	Supply overvoltages	EN 50155	W01714200900E	PASS
5	12.2.7	Surges, electrostatic discharge and transient burst susceptibility tests	EN 50155	E1710056-01E	PASS
6	12.2.8	Radio interference			
7	12.2.9	Insulation test	EN 50155	E17110014-01E	PASS
8	12.2.10	Salt mist test	EN 50155	DD20170919002	PASS
9	12.2.11	Vibration	EN 61373		
		Shock, and bump test	EN 61373		
10	12.2.12	Watertightness test	EN 50155		
11	12.2.14	Low temperature storage test	EN 50155	TC 18 02 000528	HL1&HL2
12	/	fire & smoke	EN 45545-2 R15&R16		
			EN 45545-2 R15&R16	TC.18.04.001633	HL1&HL2&HL3

Issue: 1823

In the effort to improve our products, we reserve the right to make changes judged to be necessary.

CONFIDENTIAL AND PROPRIETARY INFORMATION

This document contains confidential and proprietary information of Pulse Electronics, Inc. (Pulse) and is protected by copyright, trade secret and other state and federal laws. Its receipt or possession does not convey any rights to reproduce, disclose its contents, or to manufacture, use or sell anything it may describe. Reproduction, disclosure or use without specific written authorization of Pulse is strictly forbidden.

Description: MiMo LTE, MiMo WiFi, GNSS Vehicle Mount Antenna

Series: Panther

**PART NUMBER: GPSMB501, GPSMB502, GPSMB501R,
GPSMB502R**

MECHANICAL DRAWING

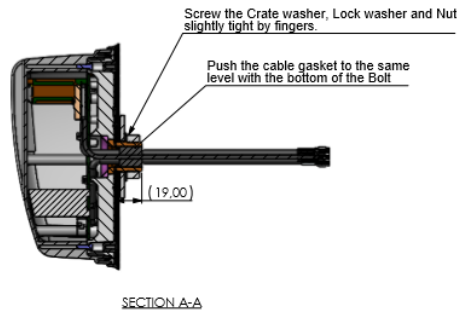
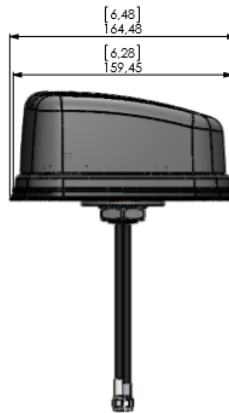
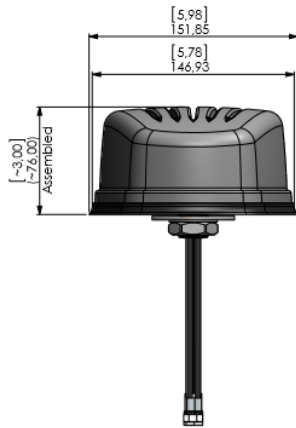

Tolerances of linear dimensions MEDIUM ISO 2768-m	
Dimension	Tolerance
0,5 - 3	± 0,1
3 - 6	± 0,1
6 - 30	± 0,2
30 - 120	± 0,3
120 - 400	± 0,5
400 - 1000	± 0,8
1000 - 2000	± 1,2
2000 - 4000	± 2

Tolerances of angular dimensions MEDIUM ISO 2768-m	
Dimension of chamfer side (millimeter)	Tolerance
up to 10	± 1°
10 - 30	± 0°30'
30 - 120	± 0°20'
120 - 400	± 0°15'
over 400	± 0°10'

Tolerances of radii and chamfers MEDIUM ISO 2768-m	
Radius chamfer height	Tolerance
0,5 - 3	± 0,2
3 - 6	± 0,3
over 6	± 1

Reference: ISO 2768-m
Tolerances of linear dimensions
Tolerances of angular dimensions
Tolerances of radii and chamfers

No riveting plates allowed to use.

Functional Characters (cc):
Please specify studies required, total 0 pcs.
Process capability studies required and ongoing statistical process control required, total 0 pcs.

Pulse Finland Oy
Toukokuu 4
02160 Espoo, Finland
Tel: +358 207 938 807
Fax: +358 207 938 801
www.pulseelectronics.com/antennas

Sheet number:	2/2
General tolerance:	
Customer number:	
Date:	04.05.2018
Drawn:	Jukka
Check:	
Appro:	
Document number:	GPSMB501
Part Version:	A
Document Version:	A
Issue:	15.09.2018 Jukka
Med:	02.07.2015 Jukka
Date:	
Name:	

Please follow Pulse Limits of hazardous substances (RoHS, halogens) in the document Pulse Hazardous Substances (HS) Limits and Vendor Survey Questionnaire, Material Composition (ICM-3AN-2016).

Issue	Description
P01	Cable Tie corrected around GPS antenna.
A	Cable Tie changed/added around GPS antenna, A-Release.

Product: GPSMB501
Item Name: Antenna Assembly

Confidential:
This is a proprietary information of Pulse Finland Oy.
No reproduction, copying or release without permission.

Issue: 1823

In the effort to improve our products, we reserve the right to make changes judged to be necessary.

CONFIDENTIAL AND PROPRIETARY INFORMATION

This document contains confidential and proprietary information of Pulse Electronics, Inc. (Pulse) and is protected by copyright, trade secret and other state and federal laws. Its receipt or possession does not convey any rights to reproduce, disclose its contents, or to manufacture, use or sell anything it may describe. Reproduction, disclosure or use without specific written authorization of Pulse is strictly forbidden.

**Description: MiMo LTE, MiMo WiFi, GNSS
Vehicle Mount Antenna**

Series: Panther

**PART NUMBER: GPSMB501, GPSMB502, GPSMB501R,
GPSMB502R**

CHARTS

Return Loss and isolation in free space, LTE antennas**

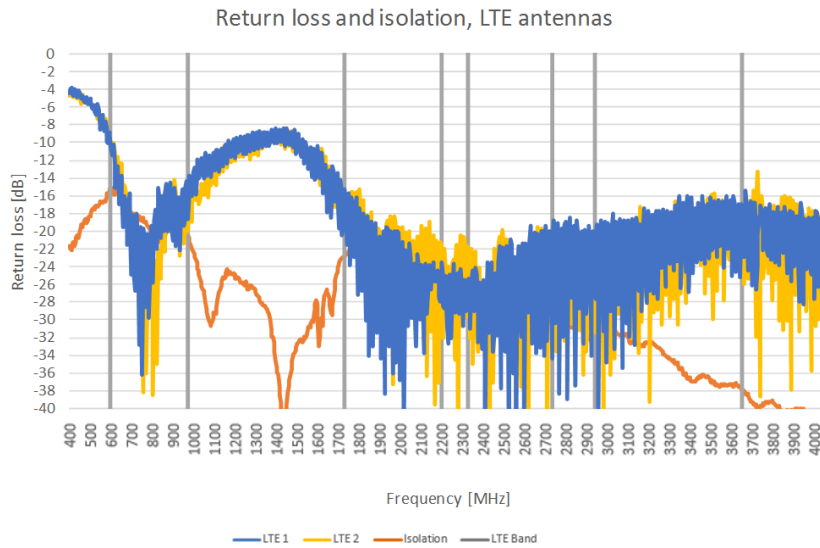

Return Loss and isolation in free space, WiFi antennas**

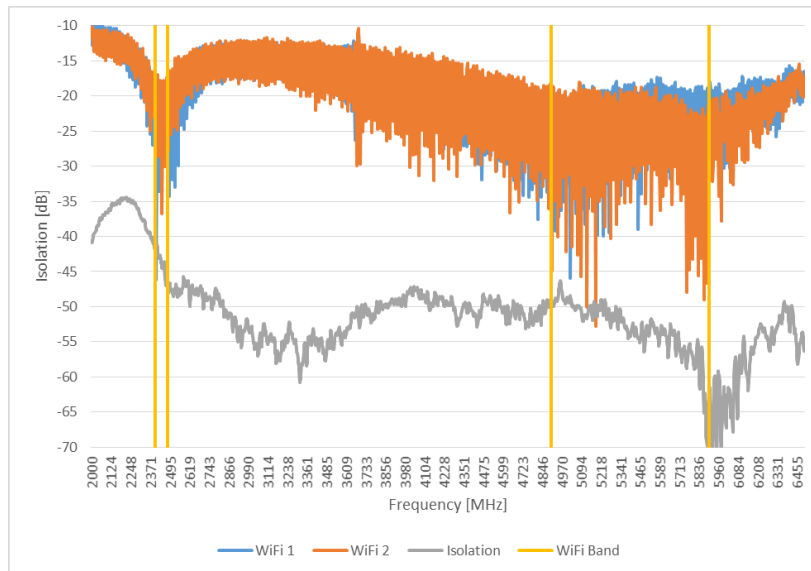

Issue: 1823

In the effort to improve our products, we reserve the right to make changes judged to be necessary.

CONFIDENTIAL AND PROPRIETARY INFORMATION

This document contains confidential and proprietary information of Pulse Electronics, Inc. (Pulse) and is protected by copyright, trade secret and other state and federal laws. Its receipt or possession does not convey any rights to reproduce, disclose its contents, or to manufacture, use or sell anything it may describe. Reproduction, disclosure or use without specific written authorization of Pulse is strictly forbidden.

**Description: MiMo LTE, MiMo WiFi, GNSS
Vehicle Mount Antenna**

Series: Panther

**PART NUMBER: GPSMB501, GPSMB502, GPSMB501R,
GPSMB502R**

CHARTS

Return Loss and isolation, LTE antennas*

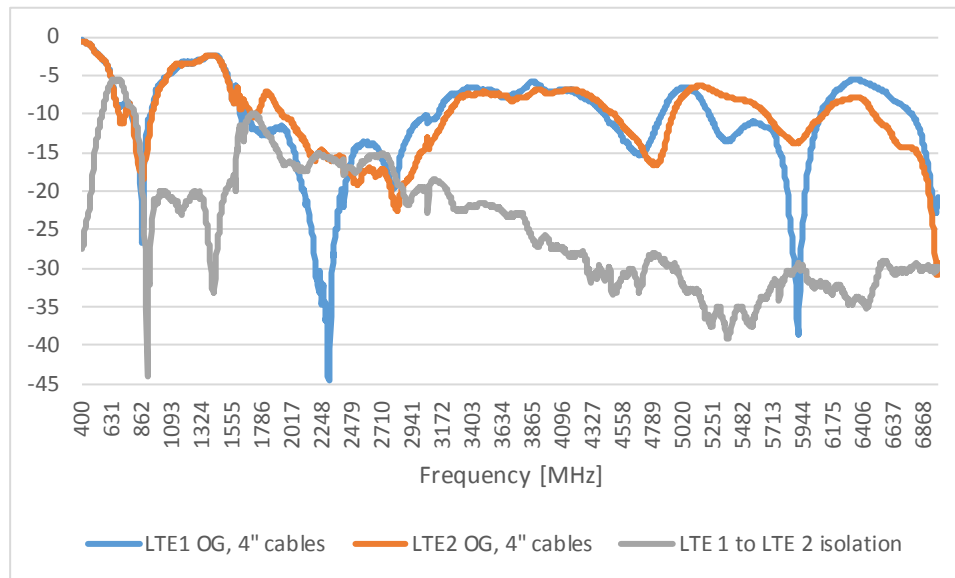

Return Loss and isolation, WiFi antennas*

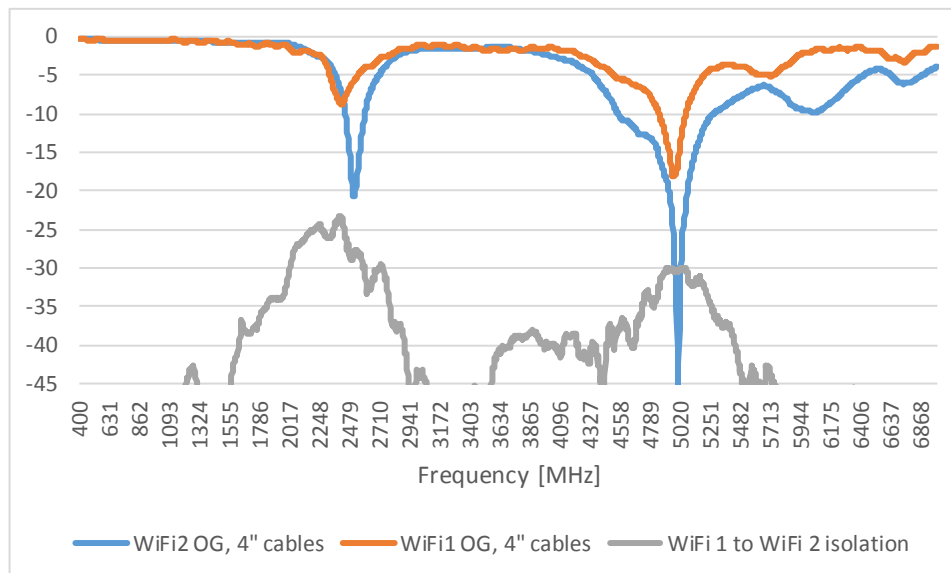

Issue: 1823

In the effort to improve our products, we reserve the right to make changes judged to be necessary.

CONFIDENTIAL AND PROPRIETARY INFORMATION

This document contains confidential and proprietary information of Pulse Electronics, Inc. (Pulse) and is protected by copyright, trade secret and other state and federal laws. Its receipt or possession does not convey any rights to reproduce, disclose its contents, or to manufacture, use or sell anything it may describe. Reproduction, disclosure or use without specific written authorization of Pulse is strictly forbidden.

**Description: MiMo LTE, MiMo WiFi, GNSS
Vehicle Mount Antenna**

Series: Panther

**PART NUMBER: GPSMB501, GPSMB502, GPSMB501R,
GPSMB502R**

CHARTS

GPS isolation to LTE 1 and LTE 2 antenna*

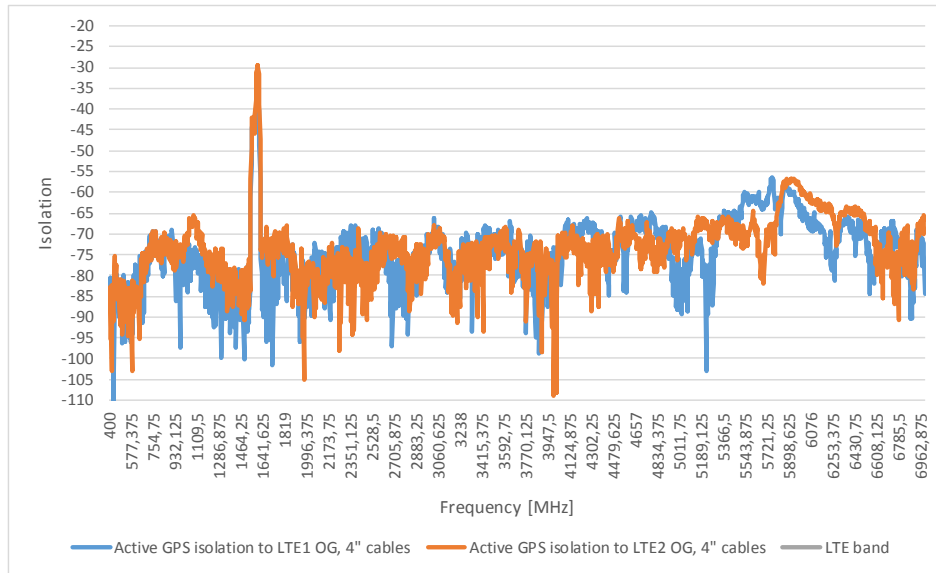

GPS isolation to WiFi 1 and WiFi 2 antenna*

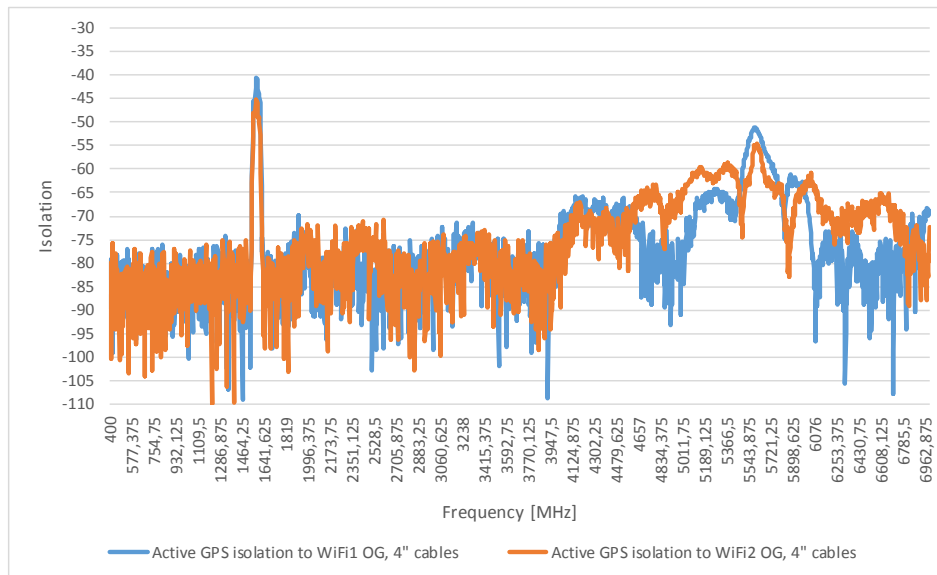

Issue: 1823

In the effort to improve our products, we reserve the right to make changes judged to be necessary.

CONFIDENTIAL AND PROPRIETARY INFORMATION

This document contains confidential and proprietary information of Pulse Electronics, Inc. (Pulse) and is protected by copyright, trade secret and other state and federal laws. Its receipt or possession does not convey any rights to reproduce, disclose its contents, or to manufacture, use or sell anything it may describe. Reproduction, disclosure or use without specific written authorization of Pulse is strictly forbidden.

**Description: MiMo LTE, MiMo WiFi, GNSS
Vehicle Mount Antenna**

Series: Panther

**PART NUMBER: GPSMB501, GPSMB502, GPSMB501R,
GPSMB502R**

CHARTS

Isolation characteristics, LTE 1 to WiFi 1 and WiFi 2*

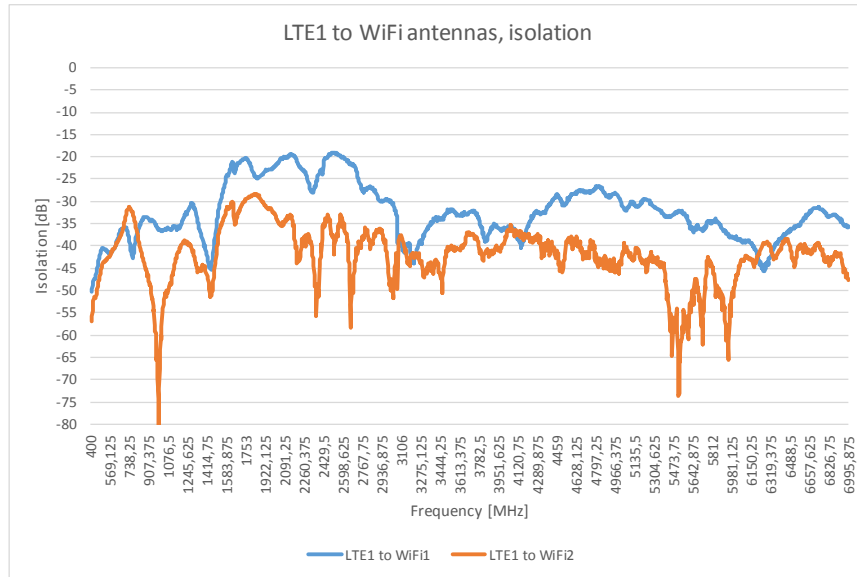

Isolation characteristics, LTE 2 to WiFi 1 and WiFi 2*

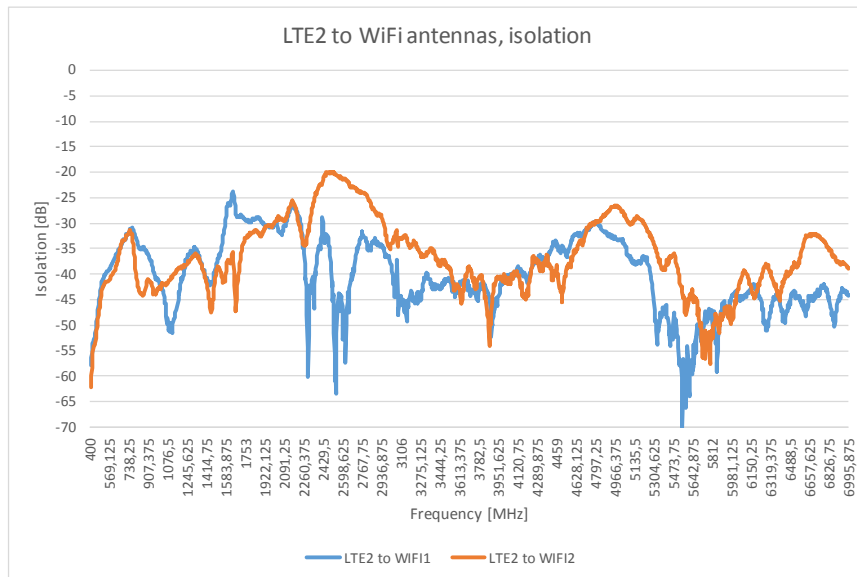

Issue: 1823

In the effort to improve our products, we reserve the right to make changes judged to be necessary.

CONFIDENTIAL AND PROPRIETARY INFORMATION

This document contains confidential and proprietary information of Pulse Electronics, Inc. (Pulse) and is protected by copyright, trade secret and other state and federal laws. Its receipt or possession does not convey any rights to reproduce, disclose its contents, or to manufacture, use or sell anything it may describe. Reproduction, disclosure or use without specific written authorization of Pulse is strictly forbidden.

Description: MiMo LTE, MiMo WiFi, GNSS
Vehicle Mount Antenna

Series: Panther

PART NUMBER: GPSMB501, GPSMB502, GPSMB501R,
GPSMB502R

CHARTS

Isolation characteristics, LTE 1 to WiFi 1 and WiFi 2**

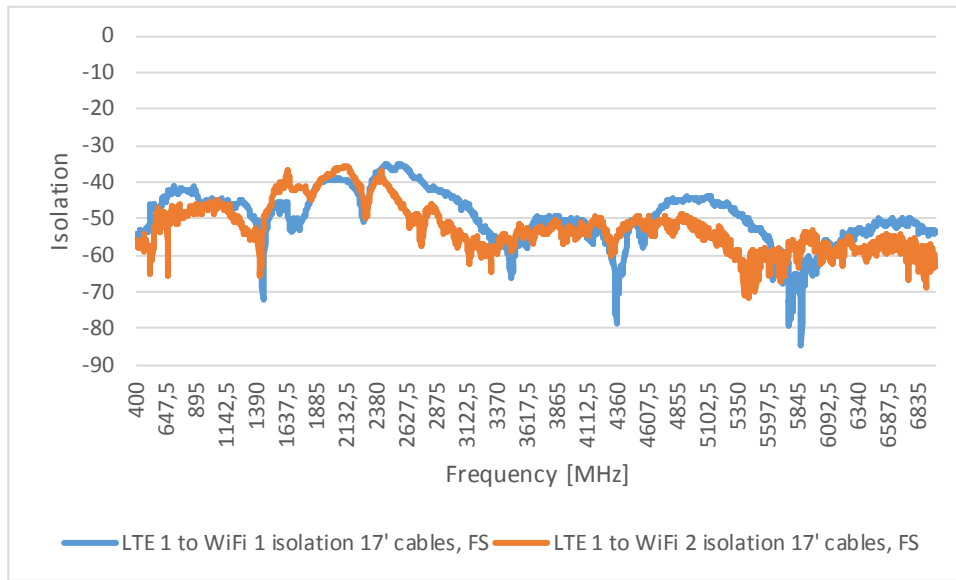

Isolation characteristics, LTE 2 to WiFi 1 and WiFi 2**

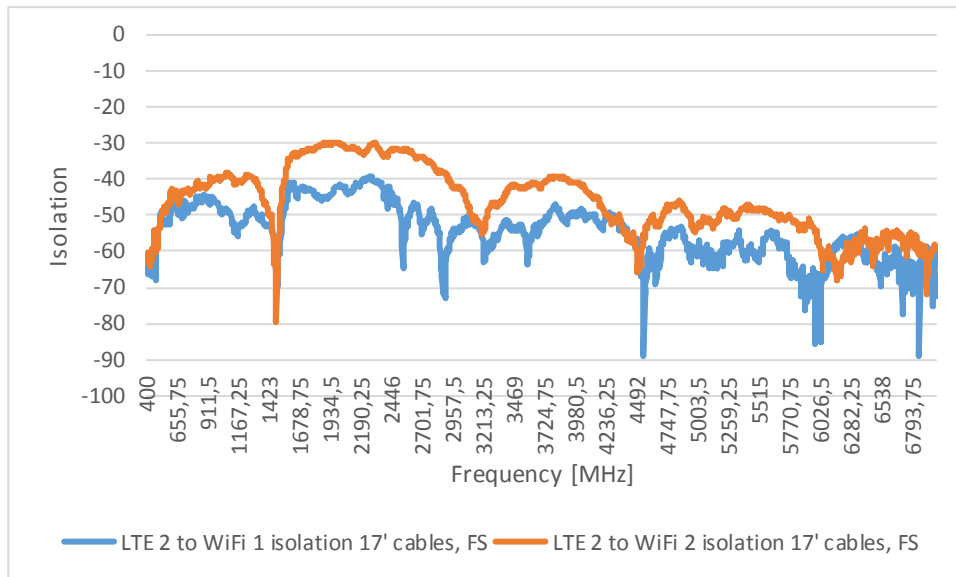

Issue: 1823

In the effort to improve our products, we reserve the right to make changes judged to be necessary.

CONFIDENTIAL AND PROPRIETARY INFORMATION

This document contains confidential and proprietary information of Pulse Electronics, Inc. (Pulse) and is protected by copyright, trade secret and other state and federal laws. Its receipt or possession does not convey any rights to reproduce, disclose its contents, or to manufacture, use or sell anything it may describe. Reproduction, disclosure or use without specific written authorization of Pulse is strictly forbidden.

Description: MiMo LTE, MiMo WiFi, GNSS
Vehicle Mount Antenna

PART NUMBER: GPSMB501, GPSMB502, GPSMB501R,
GPSMB502R

Series: Panther

CHARTS

GNSS LNA performance

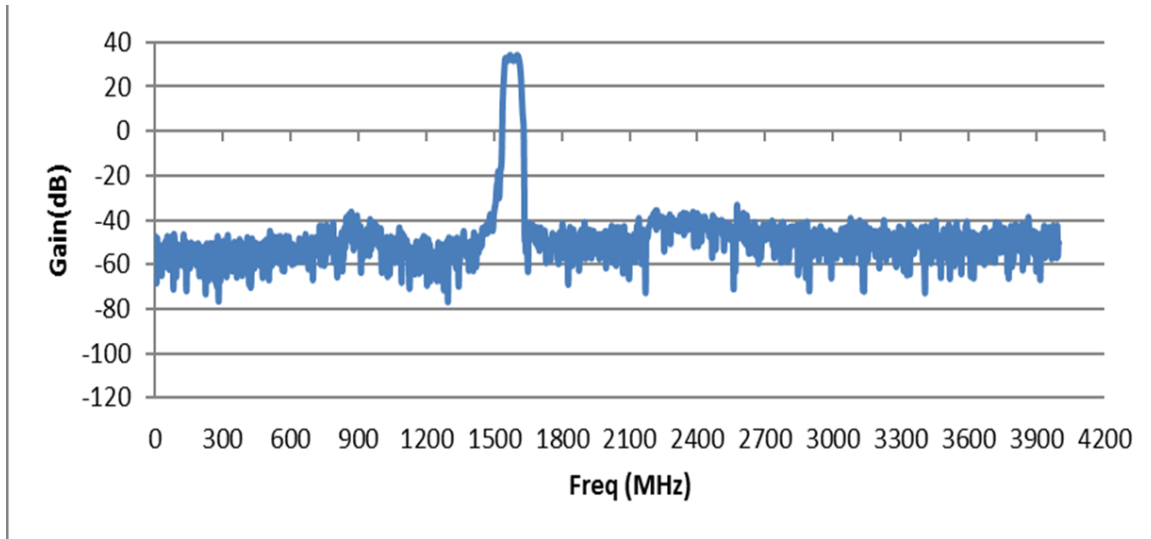

Issue: 1823

In the effort to improve our products, we reserve the right to make changes judged to be necessary.

CONFIDENTIAL AND PROPRIETARY INFORMATION

This document contains confidential and proprietary information of Pulse Electronics, Inc. (Pulse) and is protected by copyright, trade secret and other state and federal laws. Its receipt or possession does not convey any rights to reproduce, disclose its contents, or to manufacture, use or sell anything it may describe. Reproduction, disclosure or use without specific written authorization of Pulse is strictly forbidden.

**Description: MiMo LTE, MiMo WiFi, GNSS
Vehicle Mount Antenna**

Series: Panther

**PART NUMBER: GPSMB501, GPSMB502, GPSMB501R,
GPSMB502R**

CHARTS

LTE antenna total efficiency with 2ft metal plate and 4inch cables

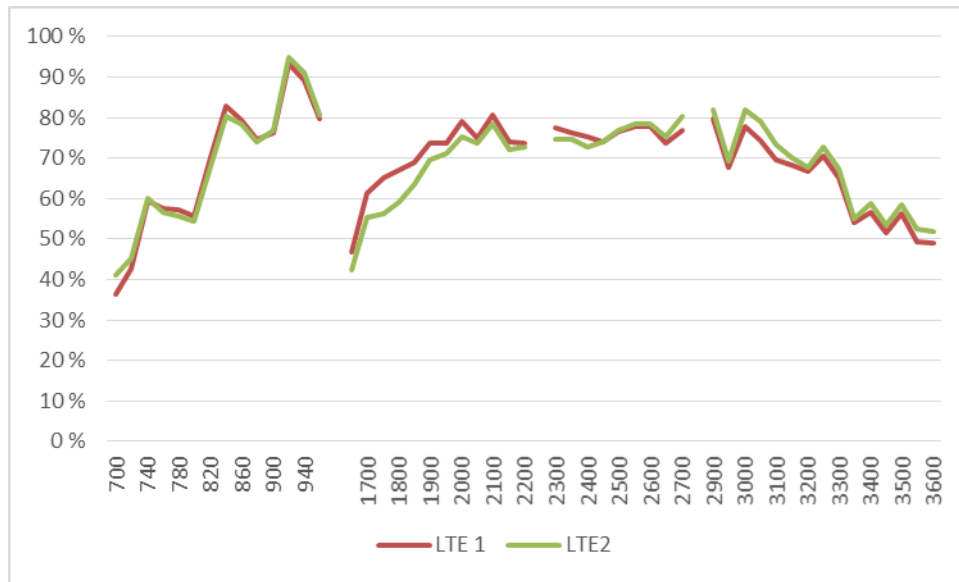

Maximum 3D gain, LTE antenna with 2ft metal plate and 4inch cables

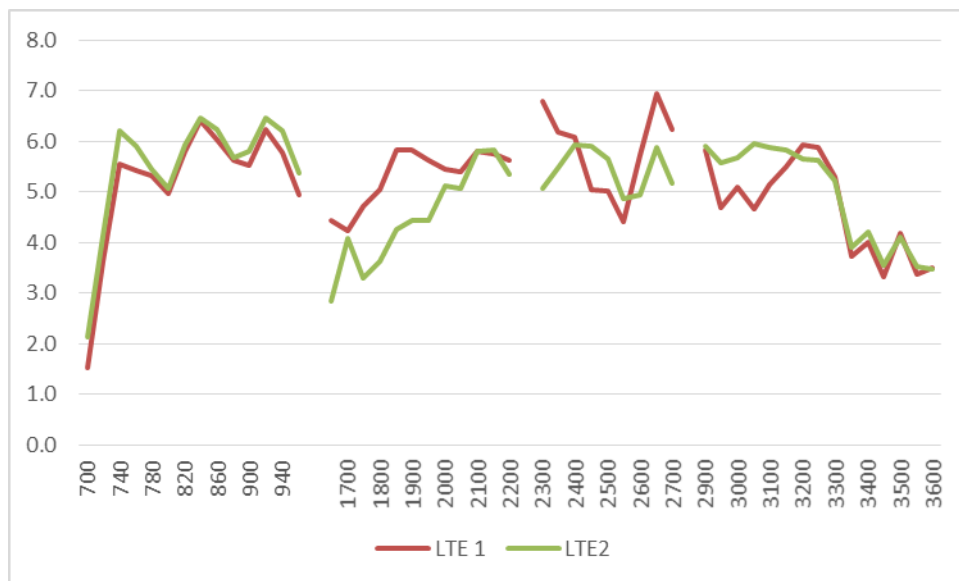

Issue: 1823

In the effort to improve our products, we reserve the right to make changes judged to be necessary.

CONFIDENTIAL AND PROPRIETARY INFORMATION

This document contains confidential and proprietary information of Pulse Electronics, Inc. (Pulse) and is protected by copyright, trade secret and other state and federal laws. Its receipt or possession does not convey any rights to reproduce, disclose its contents, or to manufacture, use or sell anything it may describe. Reproduction, disclosure or use without specific written authorization of Pulse is strictly forbidden.

**Description: MiMo LTE, MiMo WiFi, GNSS
Vehicle Mount Antenna**

Series: Panther

**PART NUMBER: GPSMB501, GPSMB502, GPSMB501R,
GPSMB502R**

CHARTS

WiFi antenna total efficiency with 2ft metal plate and 4inch cables

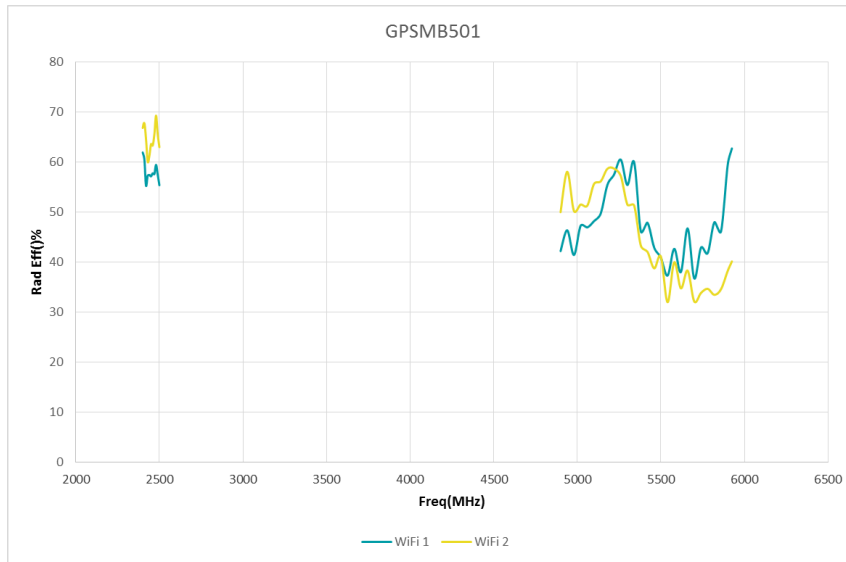

Maximum 3D gain, WiFi antenna with 2ft metal plate and 4inch cables

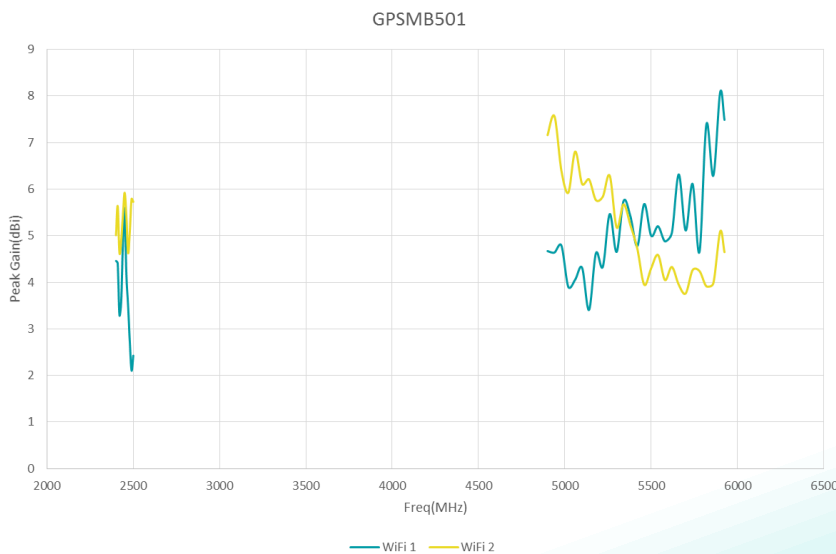

Issue: 1823

In the effort to improve our products, we reserve the right to make changes judged to be necessary.

CONFIDENTIAL AND PROPRIETARY INFORMATION

This document contains confidential and proprietary information of Pulse Electronics, Inc. (Pulse) and is protected by copyright, trade secret and other state and federal laws. Its receipt or possession does not convey any rights to reproduce, disclose its contents, or to manufacture, use or sell anything it may describe. Reproduction, disclosure or use without specific written authorization of Pulse is strictly forbidden.

**Description: MiMo LTE, MiMo WiFi, GNSS
Vehicle Mount Antenna**

Series: Panther

**PART NUMBER: GPSMB501, GPSMB502, GPSMB501R,
GPSMB502R**

CHARTS

LTE antenna radiation pattern at 850MHz with 2ft metal plate and 4inch cables

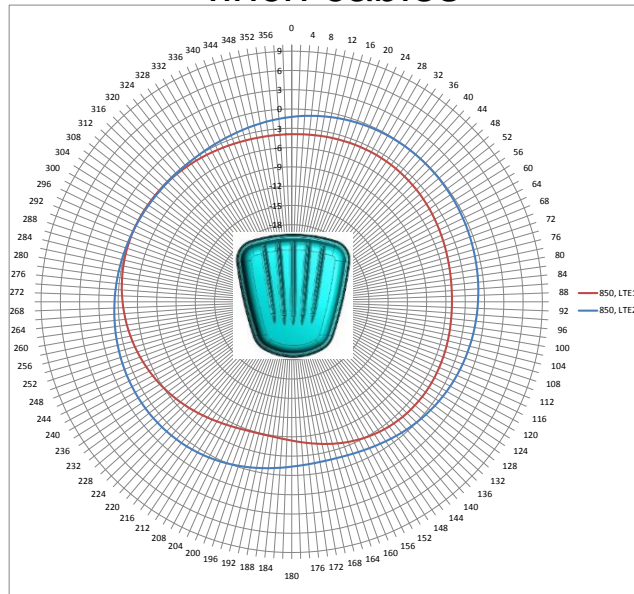

Horizontal plot

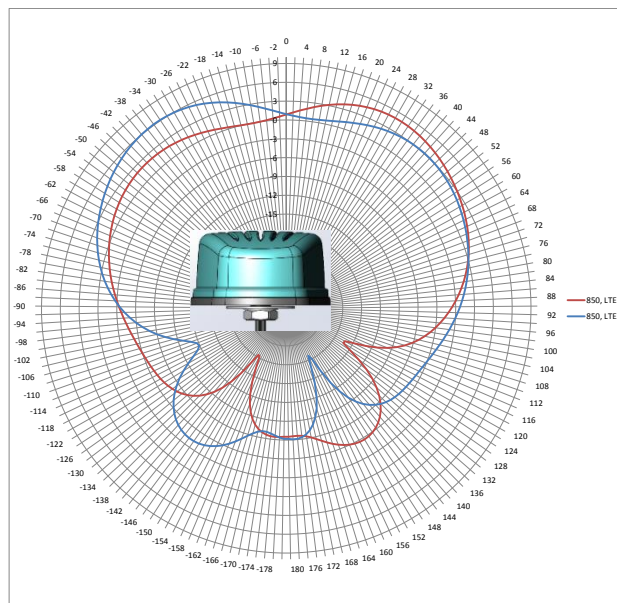

Vertical plot front view

Issue: 1823

In the effort to improve our products, we reserve the right to make changes judged to be necessary.

CONFIDENTIAL AND PROPRIETARY INFORMATION

This document contains confidential and proprietary information of Pulse Electronics, Inc. (Pulse) and is protected by copyright, trade secret and other state and federal laws. Its receipt or possession does not convey any rights to reproduce, disclose its contents, or to manufacture, use or sell anything it may describe. Reproduction, disclosure or use without specific written authorization of Pulse is strictly forbidden.

Description: MiMo LTE, MiMo WiFi, GNSS
Vehicle Mount Antenna

Series: Panther

PART NUMBER: GPSMB501, GPSMB502, GPSMB501R,
GPSMB502R

CHARTS

LTE antenna radiation pattern at 850MHz with 2ft metal plate and

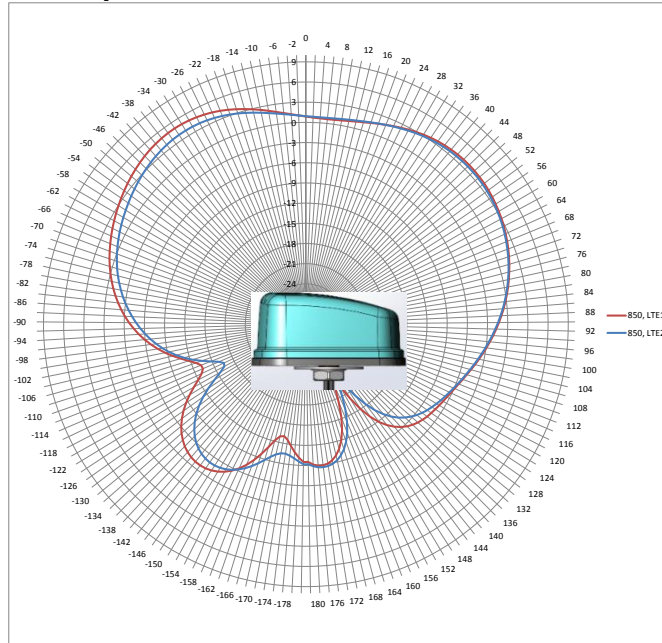

Vertical plot side view

**Description: MiMo LTE, MiMo WiFi, GNSS
Vehicle Mount Antenna**

Series: Panther

**PART NUMBER: GPSMB501, GPSMB502, GPSMB501R,
GPSMB502R**

CHARTS

LTE antenna radiation pattern at 1900MHz with 2ft metal plate and 4inch cables

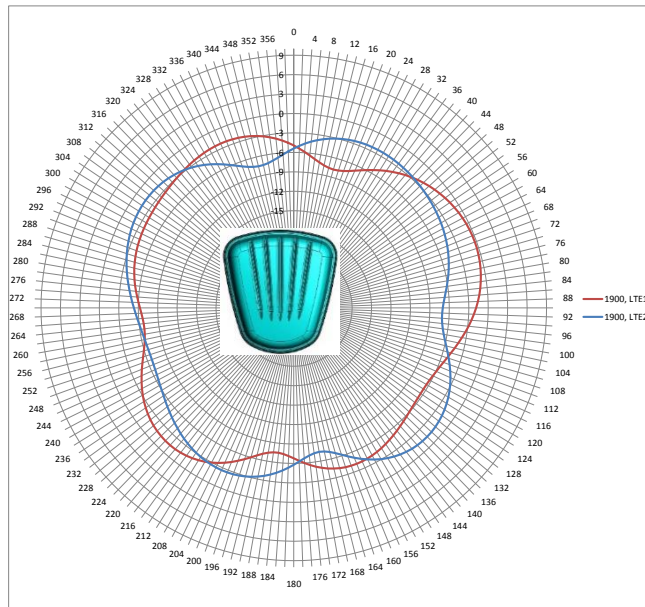

Horizontal plot

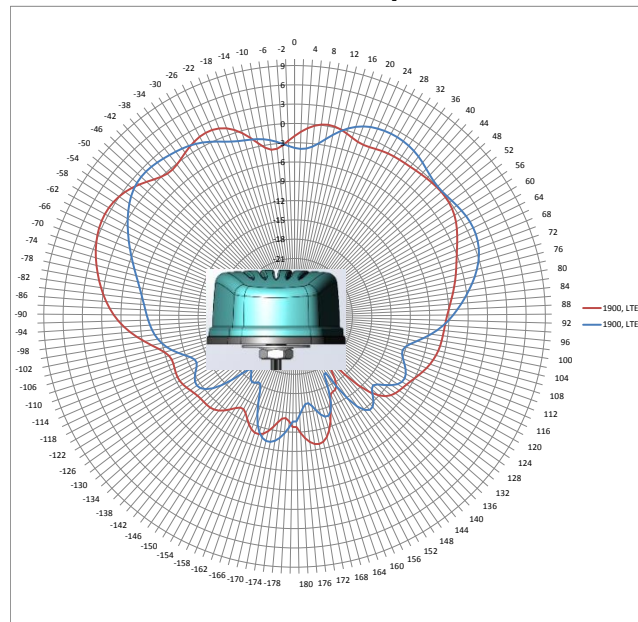

Vertical plot front view

Issue: 1823

In the effort to improve our products, we reserve the right to make changes judged to be necessary.

CONFIDENTIAL AND PROPRIETARY INFORMATION

This document contains confidential and proprietary information of Pulse Electronics, Inc. (Pulse) and is protected by copyright, trade secret and other state and federal laws. Its receipt or possession does not convey any rights to reproduce, disclose its contents, or to manufacture, use or sell anything it may describe. Reproduction, disclosure or use without specific written authorization of Pulse is strictly forbidden.

**Description: MiMo LTE, MiMo WiFi, GNSS
Vehicle Mount Antenna**

Series: Panther

**PART NUMBER: GPSMB501, GPSMB502, GPSMB501R,
GPSMB502R**

CHARTS

**LTE antenna radiation pattern at 1900MHz with 2ft metal plate and
4inch cables**

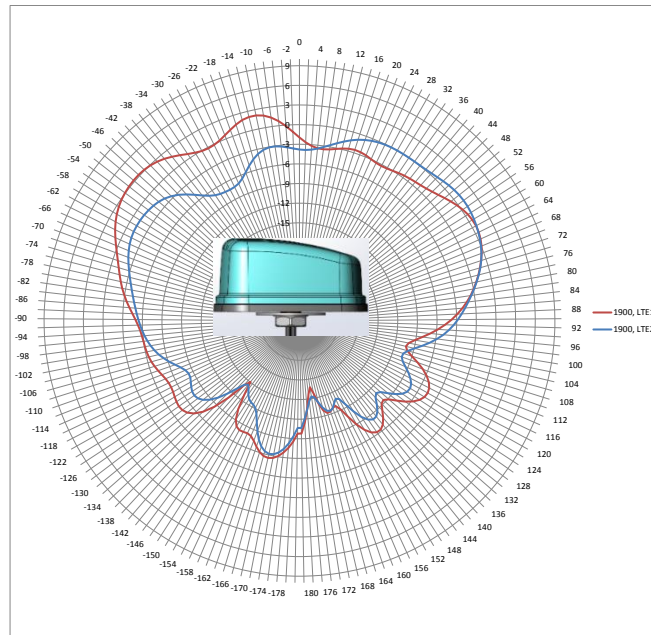

Vertical plot side view

Issue: 1823

In the effort to improve our products, we reserve the right to make changes judged to be necessary.

CONFIDENTIAL AND PROPRIETARY INFORMATION

This document contains confidential and proprietary information of Pulse Electronics, Inc. (Pulse) and is protected by copyright, trade secret and other state and federal laws. Its receipt or possession does not convey any rights to reproduce, disclose its contents, or to manufacture, use or sell anything it may describe. Reproduction, disclosure or use without specific written authorization of Pulse is strictly forbidden.

**Description: MiMo LTE, MiMo WiFi, GNSS
Vehicle Mount Antenna**

Series: Panther

**PART NUMBER: GPSMB501, GPSMB502, GPSMB501R,
GPSMB502R**

CHARTS

LTE antenna radiation pattern at 2500MHz with 2ft metal plate and 4inch cables

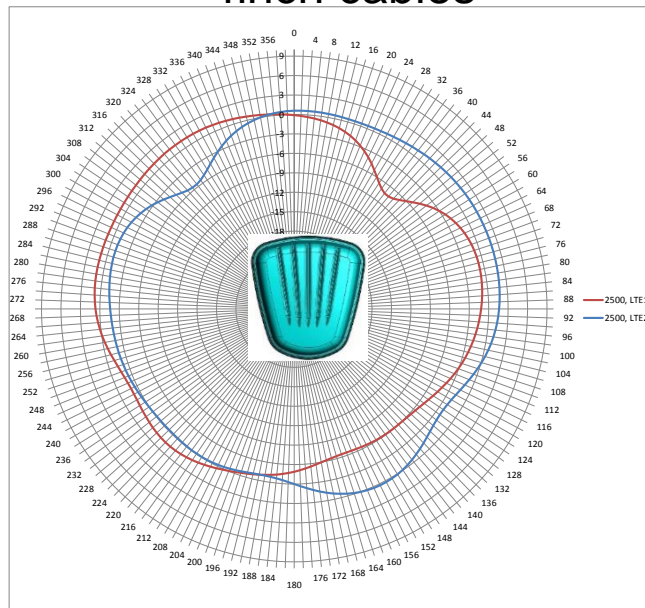

Horizontal plot

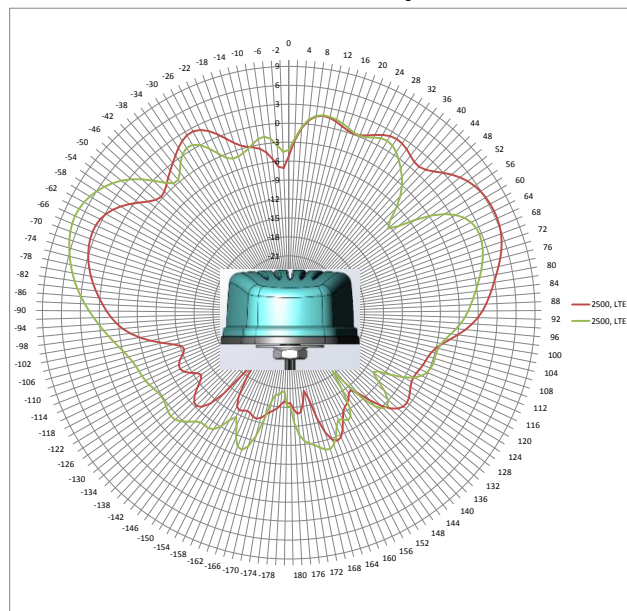

Vertical plot front view

Issue: 1823

In the effort to improve our products, we reserve the right to make changes judged to be necessary.

CONFIDENTIAL AND PROPRIETARY INFORMATION

This document contains confidential and proprietary information of Pulse Electronics, Inc. (Pulse) and is protected by copyright, trade secret and other state and federal laws. Its receipt or possession does not convey any rights to reproduce, disclose its contents, or to manufacture, use or sell anything it may describe. Reproduction, disclosure or use without specific written authorization of Pulse is strictly forbidden.

**Description: MiMo LTE, MiMo WiFi, GNSS
Vehicle Mount Antenna**

Series: Panther

**PART NUMBER: GPSMB501, GPSMB502, GPSMB501R,
GPSMB502R**

CHARTS

LTE antenna radiation pattern at 2500MHz with 2ft metal plate and 4inch cables

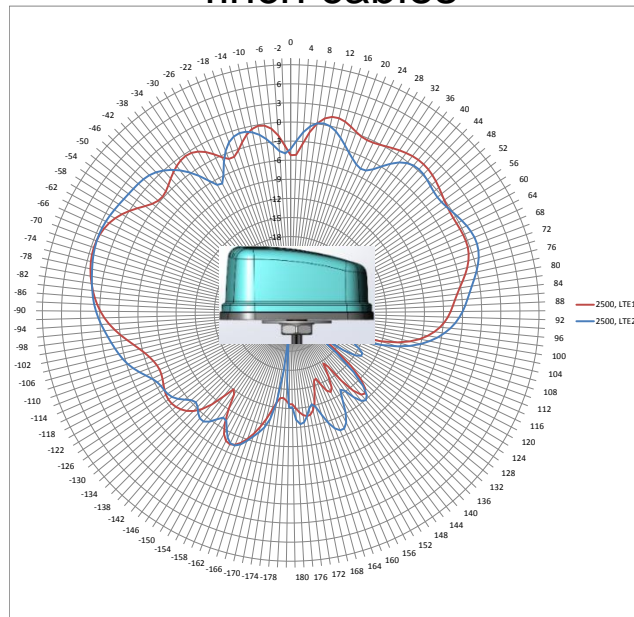

Vertical plot side view

Issue: 1823

In the effort to improve our products, we reserve the right to make changes judged to be necessary.

CONFIDENTIAL AND PROPRIETARY INFORMATION

This document contains confidential and proprietary information of Pulse Electronics, Inc. (Pulse) and is protected by copyright, trade secret and other state and federal laws. Its receipt or possession does not convey any rights to reproduce, disclose its contents, or to manufacture, use or sell anything it may describe. Reproduction, disclosure or use without specific written authorization of Pulse is strictly forbidden.

**Description: MiMo LTE, MiMo WiFi, GNSS
Vehicle Mount Antenna**

Series: Panther

**PART NUMBER: GPSMB501, GPSMB502, GPSMB501R,
GPSMB502R**

CHARTS

LTE antenna radiation pattern at 3250MHz with 2ft metal plate and 4inch cables

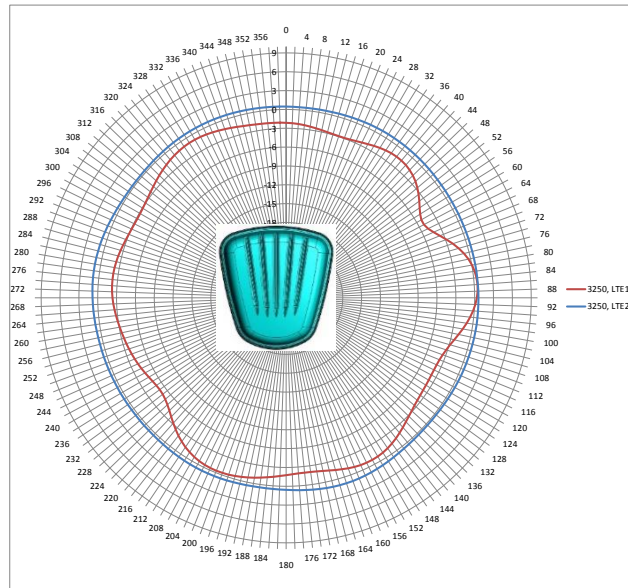

Horizontal plot

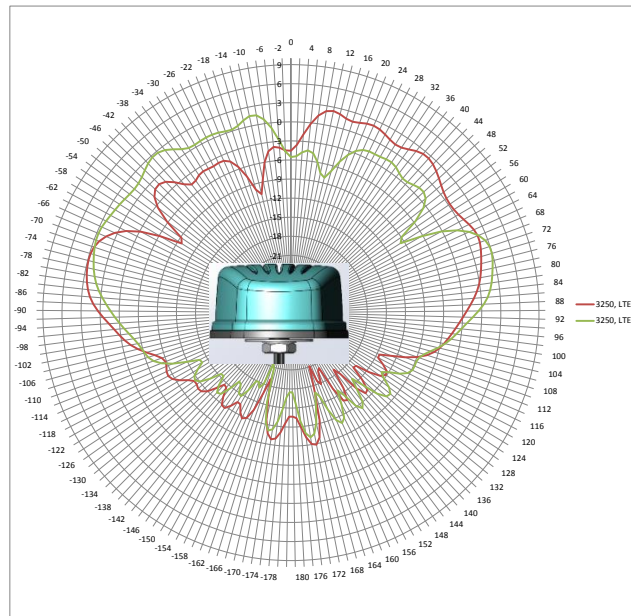

Vertical plot front view

Issue: 1823

In the effort to improve our products, we reserve the right to make changes judged to be necessary.

CONFIDENTIAL AND PROPRIETARY INFORMATION

This document contains confidential and proprietary information of Pulse Electronics, Inc. (Pulse) and is protected by copyright, trade secret and other state and federal laws. Its receipt or possession does not convey any rights to reproduce, disclose its contents, or to manufacture, use or sell anything it may describe. Reproduction, disclosure or use without specific written authorization of Pulse is strictly forbidden.

**Description: MiMo LTE, MiMo WiFi, GNSS
Vehicle Mount Antenna**

Series: Panther

**PART NUMBER: GPSMB501, GPSMB502, GPSMB501R,
GPSMB502R**

CHARTS

LTE antenna radiation pattern at 3250MHz with 2ft metal plate and 4inch cables

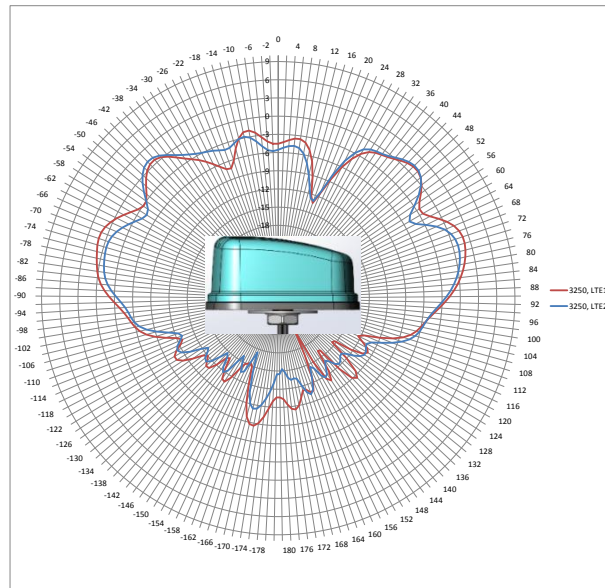

Vertical plot side view

Issue: 1823

In the effort to improve our products, we reserve the right to make changes judged to be necessary.

CONFIDENTIAL AND PROPRIETARY INFORMATION

This document contains confidential and proprietary information of Pulse Electronics, Inc. (Pulse) and is protected by copyright, trade secret and other state and federal laws. Its receipt or possession does not convey any rights to reproduce, disclose its contents, or to manufacture, use or sell anything it may describe. Reproduction, disclosure or use without specific written authorization of Pulse is strictly forbidden.

**Description: MiMo LTE, MiMo WiFi, GNSS
Vehicle Mount Antenna**

Series: Panther

**PART NUMBER: GPSMB501, GPSMB502, GPSMB501R,
GPSMB502R**

CHARTS

WiFi antenna radiation pattern at 2440MHz with 2ft metal plate and 4inch cables

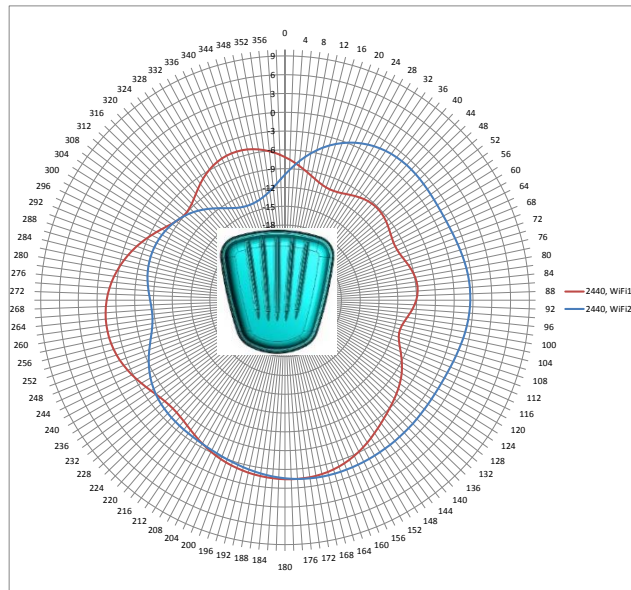

Horizontal plot

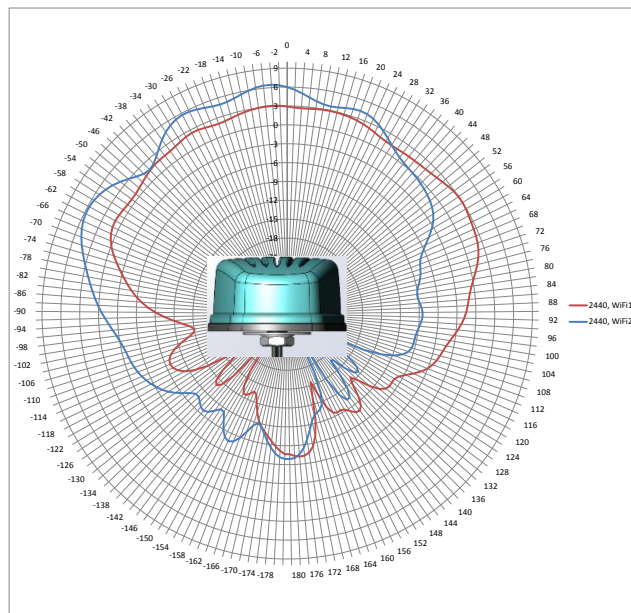

Vertical plot front view

Issue: 1823

In the effort to improve our products, we reserve the right to make changes judged to be necessary.

CONFIDENTIAL AND PROPRIETARY INFORMATION

This document contains confidential and proprietary information of Pulse Electronics, Inc. (Pulse) and is protected by copyright, trade secret and other state and federal laws. Its receipt or possession does not convey any rights to reproduce, disclose its contents, or to manufacture, use or sell anything it may describe. Reproduction, disclosure or use without specific written authorization of Pulse is strictly forbidden.

**Description: MiMo LTE, MiMo WiFi, GNSS
Vehicle Mount Antenna**

Series: Panther

**PART NUMBER: GPSMB501, GPSMB502, GPSMB501R,
GPSMB502R**

CHARTS

WiFi antenna radiation pattern at 2440MHz with 2ft metal plate and 4inch cables

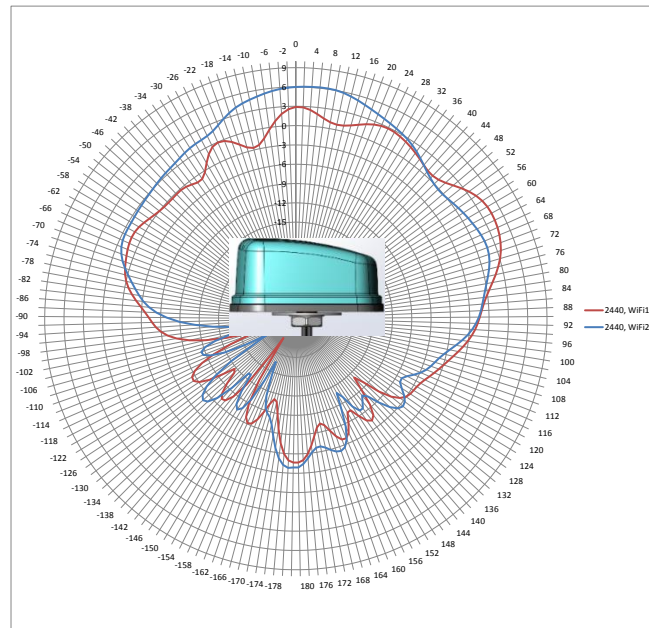

Vertical plot side view

Issue: 1823

In the effort to improve our products, we reserve the right to make changes judged to be necessary.

CONFIDENTIAL AND PROPRIETARY INFORMATION

This document contains confidential and proprietary information of Pulse Electronics, Inc. (Pulse) and is protected by copyright, trade secret and other state and federal laws. Its receipt or possession does not convey any rights to reproduce, disclose its contents, or to manufacture, use or sell anything it may describe. Reproduction, disclosure or use without specific written authorization of Pulse is strictly forbidden.

**Description: MiMo LTE, MiMo WiFi, GNSS
Vehicle Mount Antenna**

Series: Panther

**PART NUMBER: GPSMB501, GPSMB502, GPSMB501R,
GPSMB502R**

CHARTS

WiFi antenna radiation pattern at 5500MHz with 2ft metal plate and 4inch cables

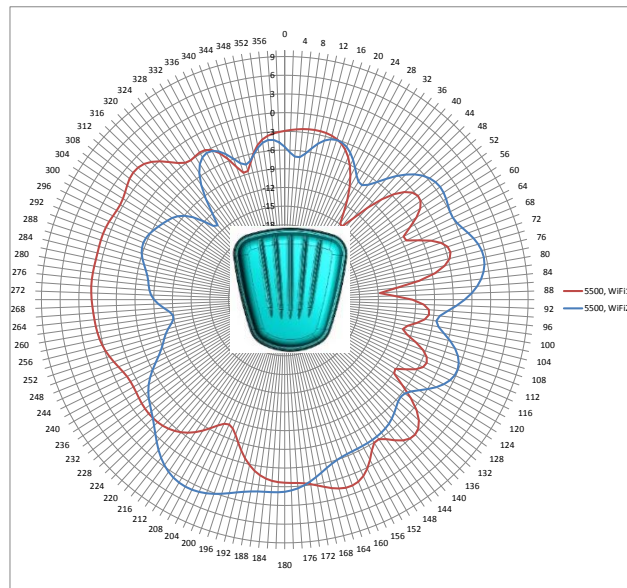

Horizontal plot

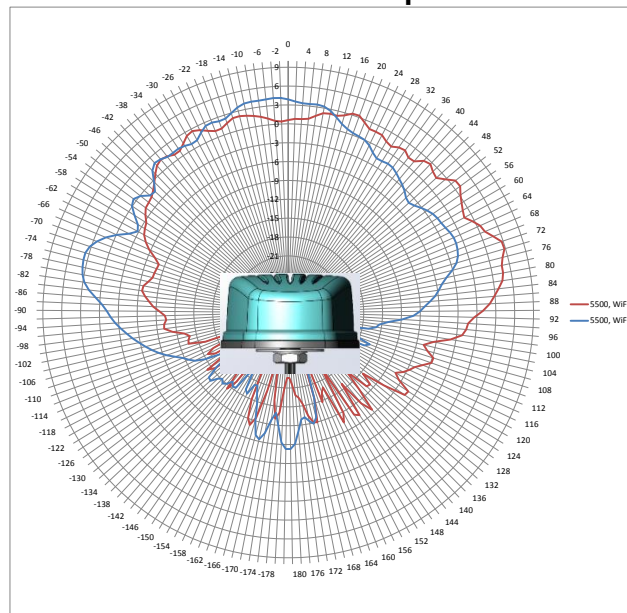

Vertical plot front view

Issue: 1823

In the effort to improve our products, we reserve the right to make changes judged to be necessary.

CONFIDENTIAL AND PROPRIETARY INFORMATION

This document contains confidential and proprietary information of Pulse Electronics, Inc. (Pulse) and is protected by copyright, trade secret and other state and federal laws. Its receipt or possession does not convey any rights to reproduce, disclose its contents, or to manufacture, use or sell anything it may describe. Reproduction, disclosure or use without specific written authorization of Pulse is strictly forbidden.

**Description: MiMo LTE, MiMo WiFi, GNSS
Vehicle Mount Antenna**

Series: Panther

**PART NUMBER: GPSMB501, GPSMB502, GPSMB501R,
GPSMB502R**

CHARTS

WiFi antenna radiation pattern at 5500MHz with 2ft metal plate and 4inch cables

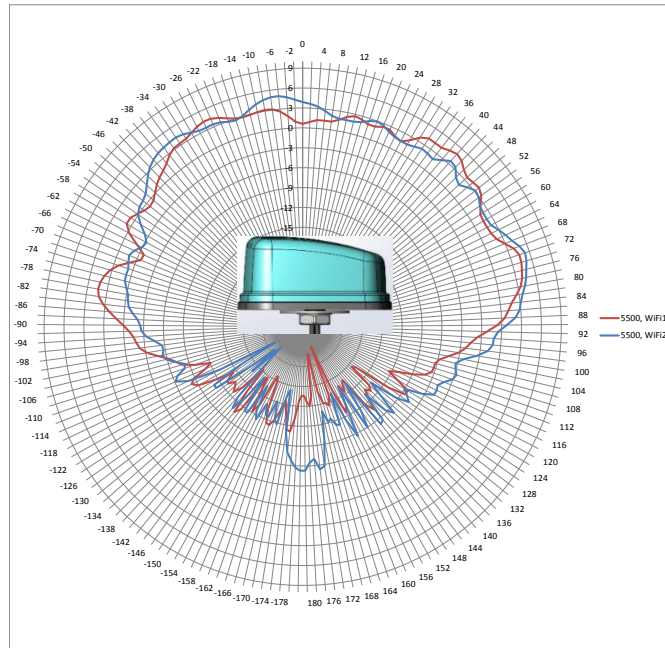

Vertical plot side view

Issue: 1823

In the effort to improve our products, we reserve the right to make changes judged to be necessary.

CONFIDENTIAL AND PROPRIETARY INFORMATION

This document contains confidential and proprietary information of Pulse Electronics, Inc. (Pulse) and is protected by copyright, trade secret and other state and federal laws. Its receipt or possession does not convey any rights to reproduce, disclose its contents, or to manufacture, use or sell anything it may describe. Reproduction, disclosure or use without specific written authorization of Pulse is strictly forbidden.

**Description: MiMo LTE, MiMo WiFi, GNSS
Vehicle Mount Antenna**

Series: Panther

**PART NUMBER: GPSMB501, GPSMB502, GPSMB501R,
GPSMB502R**

CHARTS

BD2 RHCP patterns, measured with 4inch cables in free space

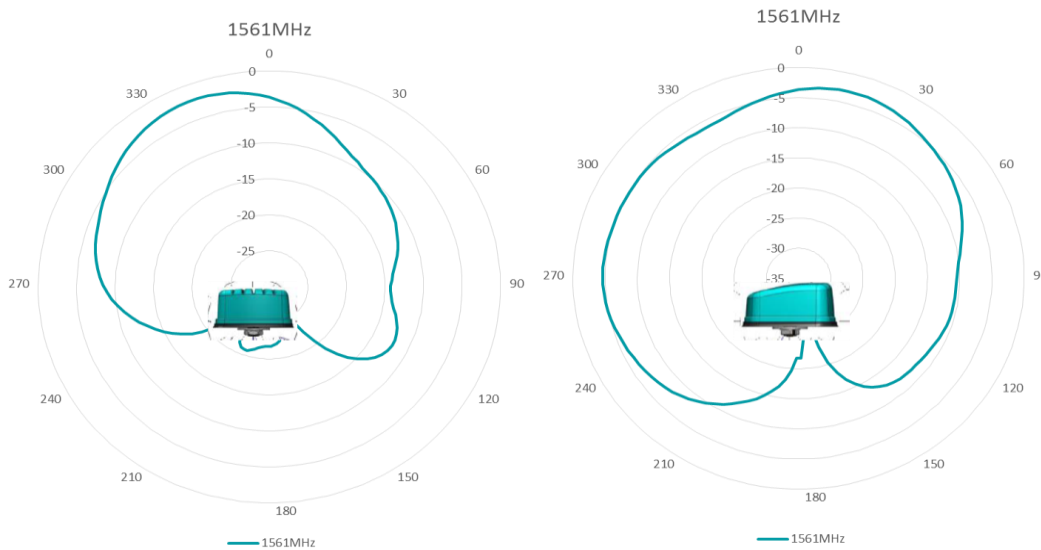

GPS & Galileo RHCP patterns, measured with 4inch cables in free space

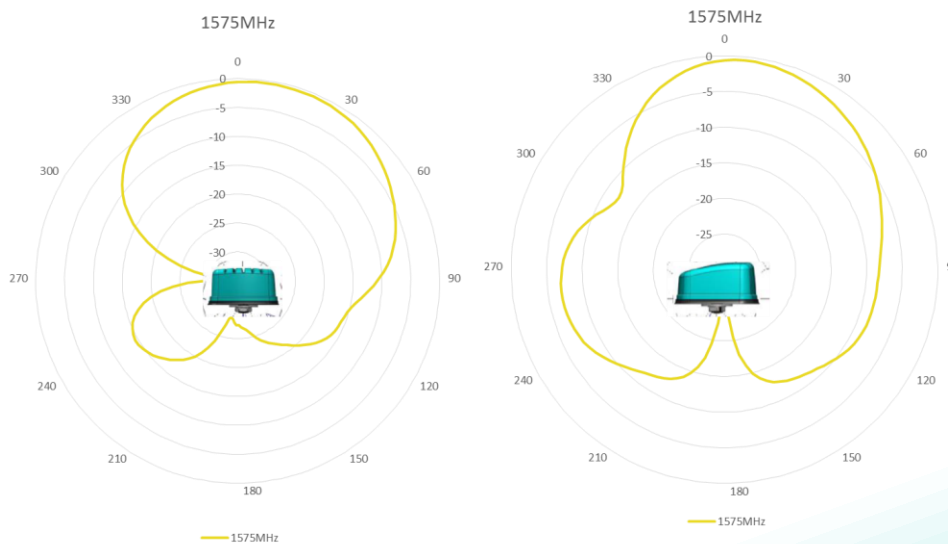

Issue: 1823

In the effort to improve our products, we reserve the right to make changes judged to be necessary.

CONFIDENTIAL AND PROPRIETARY INFORMATION

This document contains confidential and proprietary information of Pulse Electronics, Inc. (Pulse) and is protected by copyright, trade secret and other state and federal laws. Its receipt or possession does not convey any rights to reproduce, disclose its contents, or to manufacture, use or sell anything it may describe. Reproduction, disclosure or use without specific written authorization of Pulse is strictly forbidden.

**Description: MiMo LTE, MiMo WiFi, GNSS
Vehicle Mount Antenna**

Series: Panther

**PART NUMBER: GPSMB501, GPSMB502, GPSMB501R,
GPSMB502R**

CHARTS

GLONASS RHCP patterns, measured with 4inch cables in free space

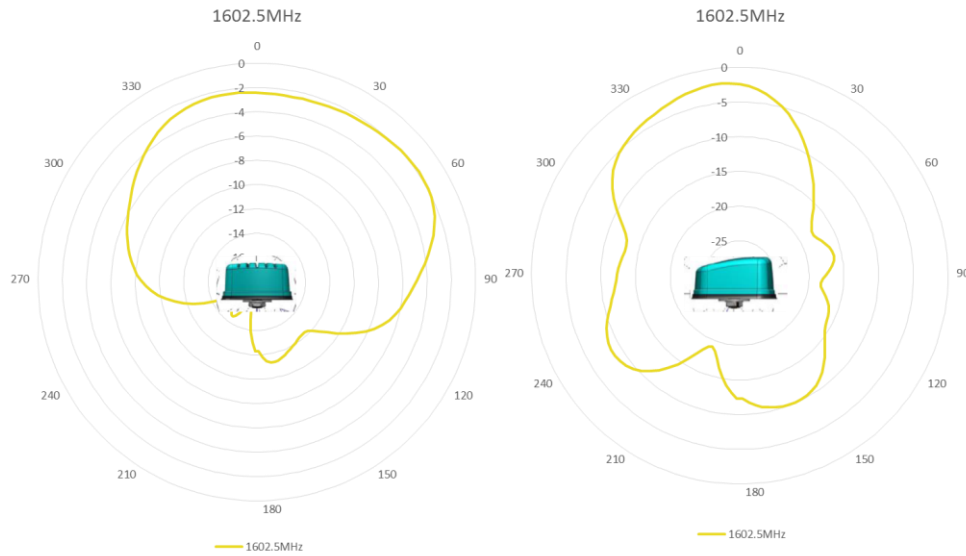

Issue: 1823

In the effort to improve our products, we reserve the right to make changes judged to be necessary.

CONFIDENTIAL AND PROPRIETARY INFORMATION

This document contains confidential and proprietary information of Pulse Electronics, Inc. (Pulse) and is protected by copyright, trade secret and other state and federal laws. Its receipt or possession does not convey any rights to reproduce, disclose its contents, or to manufacture, use or sell anything it may describe. Reproduction, disclosure or use without specific written authorization of Pulse is strictly forbidden.

**Description: MiMo LTE, MiMo WiFi, GNSS
Vehicle Mount Antenna**

Series: Panther

**PART NUMBER: GPSMB501, GPSMB502, GPSMB501R,
GPSMB502R**

CHARTS

Envelope correlation coefficient – LTE 1 to LTE 2

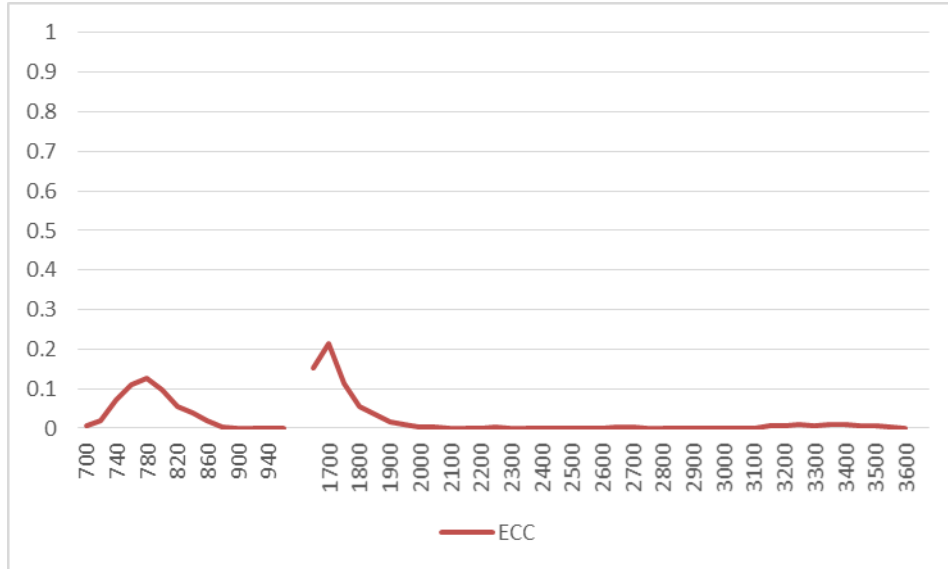

Envelope correlation coefficient – WiFi 1 to WiFi 2

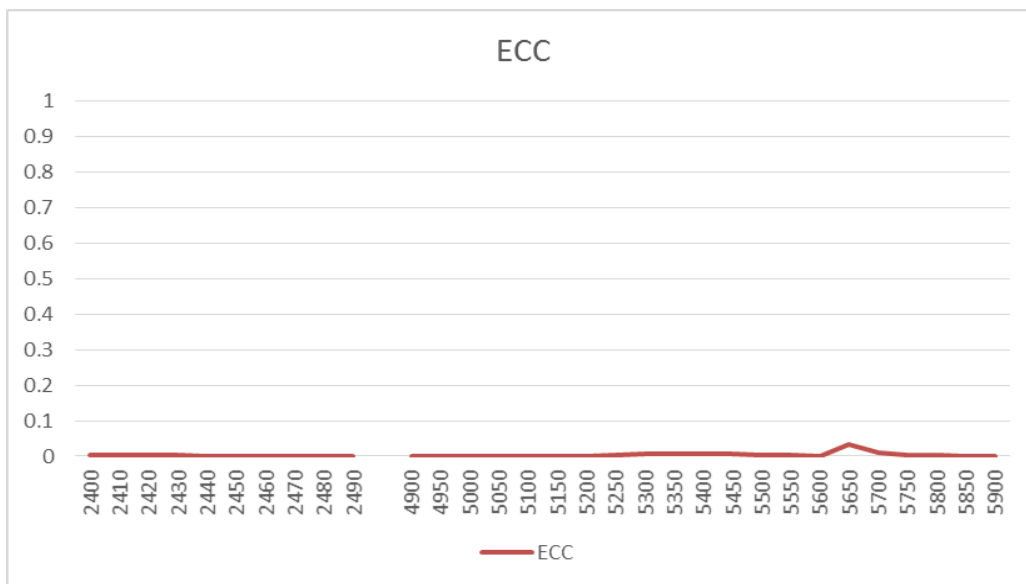

Issue: 1823

In the effort to improve our products, we reserve the right to make changes judged to be necessary.

CONFIDENTIAL AND PROPRIETARY INFORMATION

This document contains confidential and proprietary information of Pulse Electronics, Inc. (Pulse) and is protected by copyright, trade secret and other state and federal laws. Its receipt or possession does not convey any rights to reproduce, disclose its contents, or to manufacture, use or sell anything it may describe. Reproduction, disclosure or use without specific written authorization of Pulse is strictly forbidden.

**Description: MiMo LTE, MiMo WiFi, GNSS
Vehicle Mount Antenna**

Series: Panther

**PART NUMBER: GPSMB501, GPSMB502, GPSMB501R,
GPSMB502R**

PACKAGING

One antenna pack in one PE bag, 6 antennae in one box

Mouser Electronics

Authorized Distributor

Click to View Pricing, Inventory, Delivery & Lifecycle Information:

Pulse:

[GPSMB501](#)