



EC5SBW-C(D)MF SERIES

30 WATT 4:1 INPUT

ISOLATED DC-DC CONVERTER

Features

- Efficiency up to 90%
- Fixed Switching Frequency
- Regulated Outputs
- Remote On/Off
- Low No Load Power Consumption
- Fully Protected (OTP/OCP/OVP/UVLO)
- 1500Vdc I/O Isolation
- Operating Case Temperature -40 to +105°C
- No Tantalum Capacitor Inside
- UL62368-1 Approval for DC Modules
- Safety Meets IEC/EN/UL 62368-1
- Build-In EMI Filter
- Chassis Mount/Din Rail Mount



MODEL NUMBER	INPUT VOLTAGE	OUTPUT VOLTAGE	OUTPUT CURRENT		INPUT CURRENT		% EFF.		CAPACITOR LOAD MAX.
			MIN.	MAX.	NO LOAD	FULL LOAD	(2)	(3)	
EC5SBW-24S33□-CMF EC5SBW-24S33□-DMF	10-36 VDC	3.3 VDC	0 mA	7500 mA	10 mA	1185 mA	87	85	7500uF
EC5SBW-24S05□-CMF EC5SBW-24S05□-DMF	10-36 VDC	5 VDC	0 mA	6000 mA	10 mA	1397 mA	89.5	87	6000uF
EC5SBW-24S12□-CMF EC5SBW-24S12□-DMF	10-36 VDC	12 VDC	0 mA	2500 mA	10 mA	1420 mA	88	87	2500uF
EC5SBW-24S15□-CMF EC5SBW-24S15□-DMF	10-36 VDC	15 VDC	0 mA	2000 mA	10 mA	1397 mA	89.5	87	2000uF
EC5SBW-24D12□-CMF EC5SBW-24D12□-DMF	10-36 VDC	±12 VDC	0 mA	±1250 mA	10 mA	1412 mA	88.5	86.5	1250uF
EC5SBW-24D15□-CMF EC5SBW-24D15□-DMF	10-36 VDC	±15 VDC	0 mA	±1000 mA	10 mA	1412 mA	88.5	86.5	1000uF
EC5SBW-48S33□-CMF EC5SBW-48S33□-DMF	19-74 VDC	3.3 VDC	0 mA	7500 mA	8 mA	586 mA	88	87	7500uF
EC5SBW-48S05□-CMF EC5SBW-48S05□-DMF	19-74 VDC	5 VDC	0 mA	6000 mA	8 mA	698 mA	89.5	88	6000uF
EC5SBW-48S12□-CMF EC5SBW-48S12□-DMF	19-74 VDC	12 VDC	0 mA	2500 mA	8 mA	702 mA	89	88	2500uF
EC5SBW-48S15□-CMF EC5SBW-48S15□-DMF	19-74 VDC	15 VDC	0 mA	2000 mA	8 mA	702 mA	89	88	2000uF
EC5SBW-48D12□-CMF EC5SBW-48D12□-DMF	19-74 VDC	±12 VDC	0 mA	±1250 mA	8 mA	702 mA	89	88	1250uF
EC5SBW-48D15□-CMF EC5SBW-48D15□-DMF	19-74 VDC	±15 VDC	0 mA	±1000 mA	8 mA	694 mA	90	88	1000uF

NOTE:

1. □ = N or none
2. Nominal Input Voltage 24 or 48VDC
3. Measure at 12VDC for 24 Vin, 24VDC for 48 Vin



EC5SBW-C(D)MF Series

PART NUMBER

Series	Nominal Input Voltage	Number of Outputs	Nominal Output Voltage	Remote On/Off Logic	Chassis Mount Type
EC5SBW-	II	O	XX	L	YYY
EC5SBW	24 : 24 VDC 48 : 48 VDC	S : Single D : Dual	33 : 3.3VDC 05 : 5.0VDC 12 : 12VDC 15 : 15VDC 12 : ±12VDC 15 : ±15VDC	None : Positive N : Negative	CMF : Chassis Mount Built in Filter DMF : Din Rail Mount Built in Filter

Part Number Example:

EC5SBW-24S12-CMF: Chassis Mount 30W, 4:1 10-36Vdc Input, Single 12Vdc Output, Positive Logic



EC5SBW-C(D)MF Series

TECHNICAL SPECIFICATIONS

(All specifications are typical at nominal input, full load at 25°C unless otherwise noted.)

ABSOLUTE MAXIMUM RATINGS

PARAMETER	NOTES and CONDITIONS	Device	Min.	Typ.	Max.	Units
Input Voltage	Continuous	24Vin	-0.3		36	V _{dc}
		48Vin	-0.3		74	
Input Surge Voltage	100ms max.	24Vin			50	V _{dc}
		48Vin			100	
Operating Ambient Temperature Range	With derating	All	-40		85	°C
Operating Case Temperature	At the center part of case plate	All	-40		105	°C
Storage Temperature		All	-55		125	°C

INPUT CHARACTERISTICS

PARAMETER	NOTES and CONDITIONS	Device	Min.	Typ.	Max.	Units
Operating Input Voltage		24Vin	10	24	36	V _{dc}
		48Vin	19	48	74	
Input Under Voltage Lockout						
Turn-On Voltage Threshold	100% Load	24Vin	8.8	9	9.2	V _{dc}
		48Vin	16.5	17.5	18	
Turn-Off Voltage Threshold	100% Load	24Vin	8.2	8.4	8.6	V _{dc}
		48Vin	16	16.2	16.5	
Lockout Hysteresis Voltage	100% Load	24Vin		0.5		V _{dc}
		48Vin		1		
Maximum Input Current	V _{in} =10V, Full load	24Vin		4		A
	V _{in} =19V, Full load	48Vin		2		
No-Load Input Current	V _{in} =24,48V, I _o =0A	See Model Number Table				mA

OUTPUT CHARACTERISTICS

PARAMETER	NOTES and CONDITIONS	Device	Min.	Typ.	Max.	Units
Voltage Set Point Accuracy	V _{in} =Nominal, Full load, T _c =25°C	Single	-1.5		+1.5	%
		Dual	-1.8		+1.5	
Output Voltage Balance	V _{in} =Nominal, Full load, T _c =25°C	Dual	-1.5		+1.5	%
Output Voltage Regulation						
Load Regulation	Full load to no load	3.3V&Dual			±1.0	%
		Others			±0.5	
Line Regulation	V _{in} =High line to low line, full load	Single			±0.3	%
		Dual			±0.5	
Temperature Coefficient	T _c =-40°C to 85°C	All			±0.03	%/°C
Output Voltage Ripple and Noise (5Hz to 20MHz bandwidth)						
Peak-to-Peak	Full load, 10uF tantalum and 1.0uF ceramic capacitors.	3.3 & 5 Vo			75	mV
		12 & 15 Vo			100	
Output Current Range	V _{in} =Nominal,	See Model Number Table				A
Over Current Protection	Hiccup mode. Auto recovery	All	110	140	170	%
Short Circuit Protection		All	Continuous			
External Load Capacitance	Full load (resistive)	See Model Number Table				uF
Over Voltage Protection	Zener or TVS Clamp	3.3Vo		3.9		V _{dc}
		5Vo		6.2		
		12Vo		15		
		15Vo		18		



EC5SBW-C(D)MF Series

EFFICIENCY

PARAMETER	NOTES and CONDITIONS	Device	Min.	Typ.	Max.	Units
100% Load	V_{in} =Nominal, full load, $T_c=25^{\circ}\text{C}$	See Model Number Table				%

DYNAMIC CHARACTERISTICS

PARAMETER	NOTES and CONDITIONS	Device	Min.	Typ.	Max.	Units	
Output Voltage Current Transient							
Error Band	75% to 100% of I_{o_max} step load change $dI/dt=0.1\text{A}/\mu\text{s}$ (within 1% V_{out} nominal)	All				± 5	%
Recovery Time			250	μs			
Turn-On Delay and Rise Time	Full load (Constant resistive load)						
Turn-On Delay Time, From On/Off Control	$V_{on/off}$ to 10% V_{o_set} , Remote on	All				10	ms
Turn-On Delay Time, From Input	V_{in_min} to 10% V_{o_set} , Power up	All				10	ms
Output Voltage Rise Time	10% V_{o_set} to 90% V_{o_set}	All				10	ms

ISOLATION CHARACTERISTICS

PARAMETER	NOTES and CONDITIONS	Device	Min.	Typ.	Max.	Units	
Isolation Voltage (100% factory Hi-Pot tested @2sec.)	1 Minute; input to output	All				1500	V_{ic}
Isolation Resistance	Input to output	All	1000			$\text{M}\Omega$	
Isolation Capacitance	Input to output (10KHz, 0.25V)	All	3500			pF	

FEATURE CHARACTERISTICS

PARAMETER	NOTES and CONDITIONS	Device	Min.	Typ.	Max.	Units	
Switching Frequency	Output ripple frequency	3.3&5Vo Others	240 300	270 330	300 360	KHz	
On/Off Control, Positive Remote On/Off Logic, Refer to $-V_{in}$ Pin							
Logic Low (Module Off)	$V_{on/off}$ at $I_{on/off}=1.0\text{mA}$	All	0			1.2	V
Logic High (Module On)	$V_{on/off}$ at $I_{on/off}=0.1\mu\text{A}$, Pin open=on	All	3.5 or Open Circuit		74	V	
On/Off Control, Negative Remote On/Off Logic, Refer to $-V_{in}$ Pin							
Logic High (Module Off)	$V_{on/off}$ at $I_{on/off}=0.1\mu\text{A}$, Pin open=off	All	3.5 or Open Circuit		74	V	
Logic Low (Module On)	$V_{on/off}$ at $I_{on/off}=1.0\text{mA}$	All	0			1.2	V
On/Off Current (for Both Remote On/Off Logic)	$I_{on/off}$ at $V_{on/off}=0\text{V}$	All	0.4		1	mA	
Leakage Current (for Both Remote On/Off Logic)	Logic high, $V_{on/off}=15\text{V}$	All				30	μA
Off Converter Input Current	Shutdown input idle current	All	4		10	mA	
Over Temperature Shutdown	Temperature at the center part of case (DC Module), non-latching	All	110			$^{\circ}\text{C}$	
Over Temperature Recovery		All	100			$^{\circ}\text{C}$	

GENERAL SPECIFICATIONS

PARAMETER	NOTES and CONDITIONS	Device	Min.	Typ.	Max.	Units	
MTBF	$I_o=100\%$ of I_{o_max} ; MIL-HDBK - 217F_Notice 1, GB, 25°C	24S33				848	K hours
		24S05				741	
		24S12				994	
		24S15				1121	
		24D12				1015	
		24D15				1092	



EC5SBW-C(D)MF Series

GENERAL SPECIFICATIONS

PARAMETER	NOTES and CONDITIONS	Device	Min.	Typ.	Max.	Units
MTBF	$I_o=100\%$ of $I_{o_max.}$; MIL-HDBK - 217F_Notice 1, GB, 25°C	48S33		868		K hours
		48S05		754		
		48S12		1015		
		48S15		1115		
		48D12		1021		
		48D15		1113		
Weight		CMF		66		grams
		DMF		70		
Case Material	Black Coated Copper (DC Module)					
Base plate Material	Aluminum					
Potting Material	UL 94V-0 (DC Module)					
Shock/Vibration	MIL-STD-810F					
Humidity	95% RH max. Non Condensing					
Altitude	5000m Operating Altitude, 12000m Transport Altitude					
Thermal Shock	MIL-STD-810F					
EMI	Meets EN55032, Conducted without external input filter				Class A	
ESD	IEC61000-4-2 Level 3: Air ± 8 kV, Level 2: Contact ± 4 kV				Perf. Criteria A	
Radiated immunity	EN61000-4-3 Level 2: 80~1000MHz, 3V/m				Perf. Criteria A	
Fast Transient	EN61000-4-4 Level 1: On power input port, ± 0.5 kV				Perf. Criteria A	
Surge	EN61000-4-5 Level 1: Line to line, ± 0.5 kV				Perf. Criteria A	
Conducted immunity	EN61000-4-6 Level 2: 0.15~80MHz, 3V				Perf. Criteria A	
Application Note Link	EC5SBW C(D)MF Series App Notes					
Packaging Information Link	Packaging Information					

CHARACTERISTIC CURVE

Power Derating Curve

EC5SBW-XXS33, 05-C(D)MF
Derating Curve (V_{in} =Nominal)

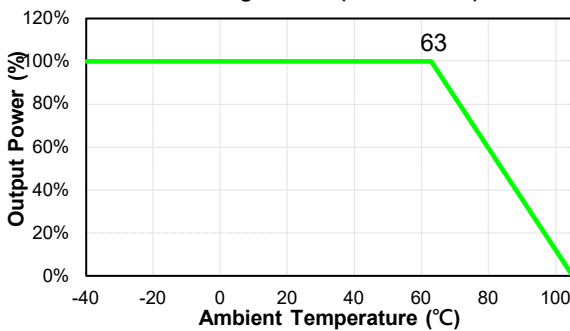

EC5SBW-XXS12,15, 48D12, 48D15-C(D)MF
Derating Curve (V_{in} =Nominal)

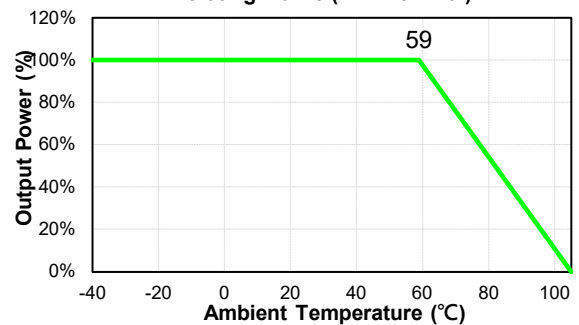

EC5SBW-24D12,15-C(D)MF
Derating Curve (V_{in} =Nominal)

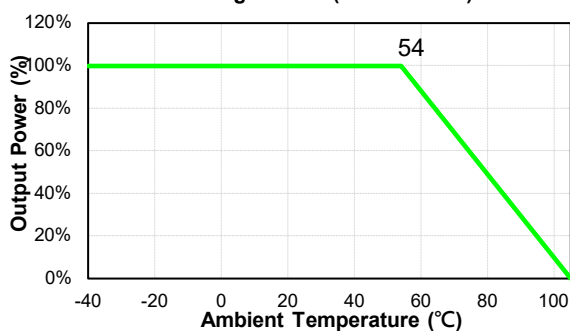



EC5SBW-C(D)MF Series

Performance Data

EC5SBW-24S33-CMF
Eff Vs Io @25 Deg. C

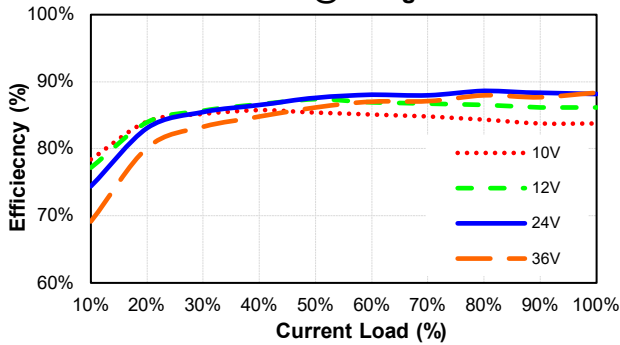

EC5SBW-24S33-CMF
Pd Vs Po @25 Deg. C

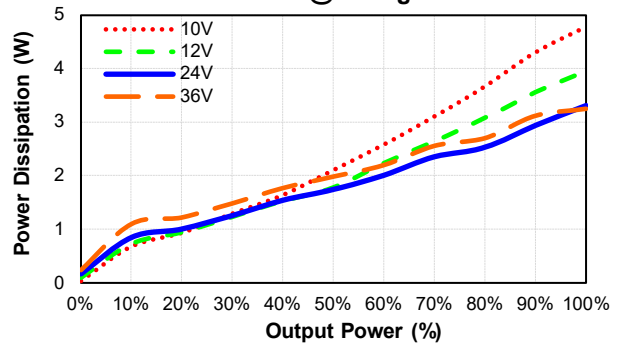

EC5SBW-24S05-CMF
Eff Vs Io @25 Deg. C

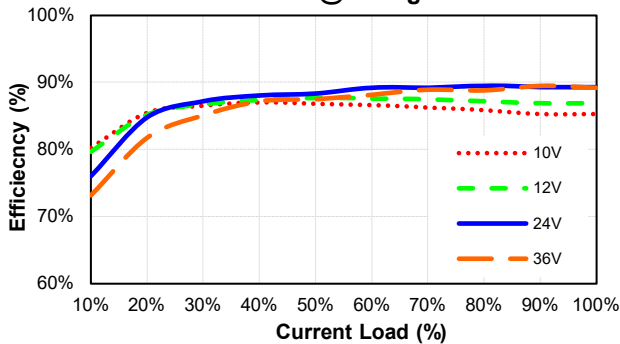

EC5SBW-24S05-CMF
Pd Vs Po @25 Deg. C

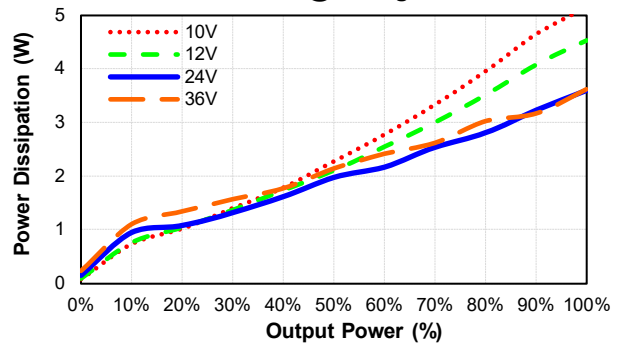

EC5SBW-24S12-CMF
Eff Vs Io @25 Deg. C

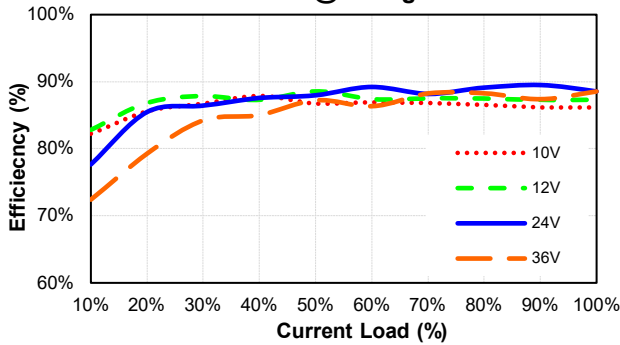

EC5SBW-24S12-CMF
Pd Vs Po @25 Deg. C

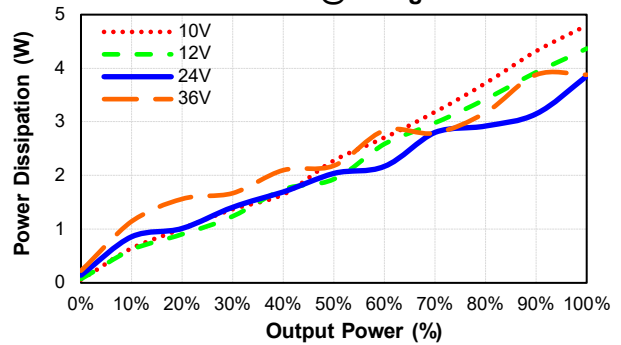

EC5SBW-24S15-CMF
Eff Vs Io @25 Deg. C

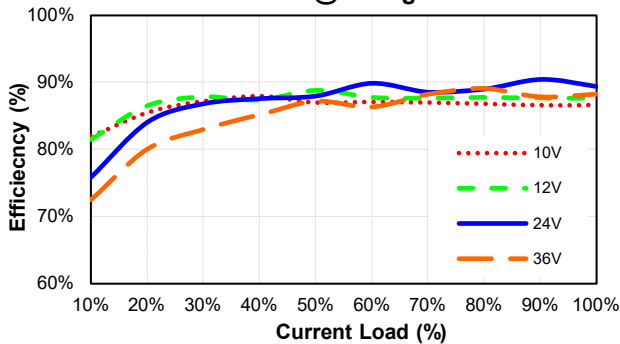

EC5SBW-24S15-CMF
Pd Vs Po @25 Deg. C

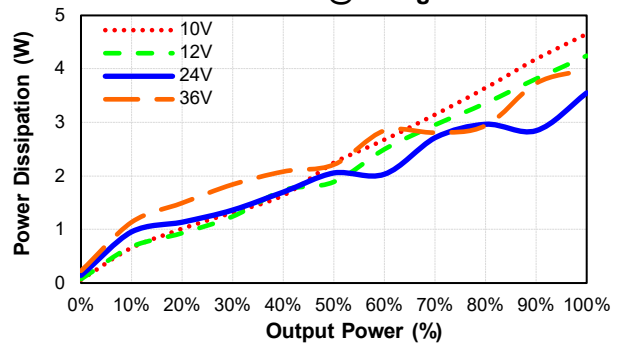



EC5SBW-C(D)MF Series

EC5SBW-24D12-CMF
Eff Vs Io @25 Deg. C

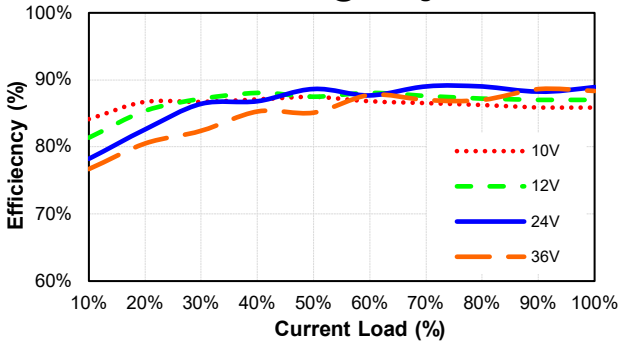

EC5SBW-24D12-CMF
Pd Vs Po @25 Deg. C

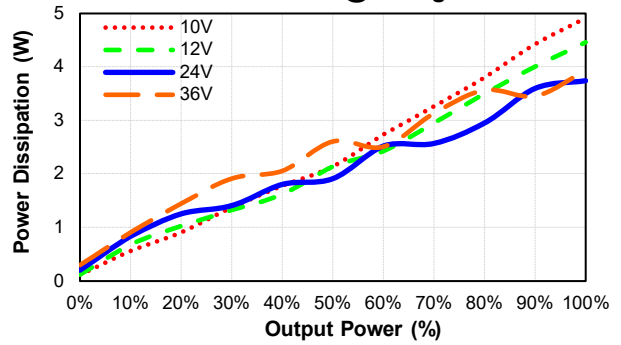

EC5SBW-24D15-CMF
Eff Vs Io @25 Deg. C

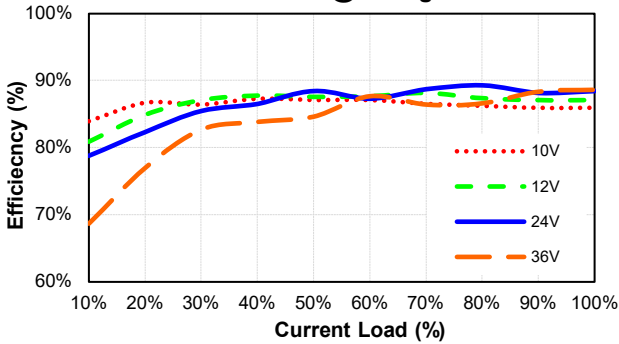

EC5SBW-24D15-CMF
Pd Vs Po @25 Deg. C

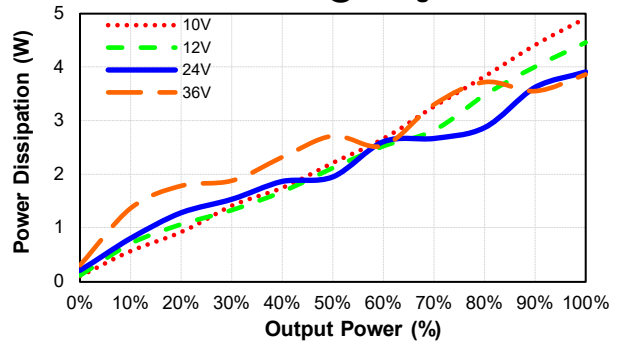

EC5SBW-48S33-CMF
Eff Vs Io @25 Deg. C

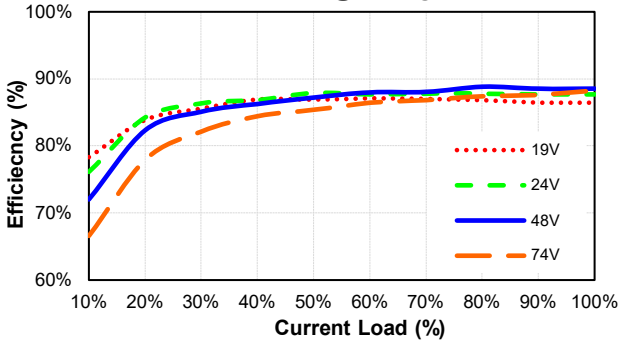

EC5SBW-48S33-CMF
Pd Vs Po @25 Deg. C

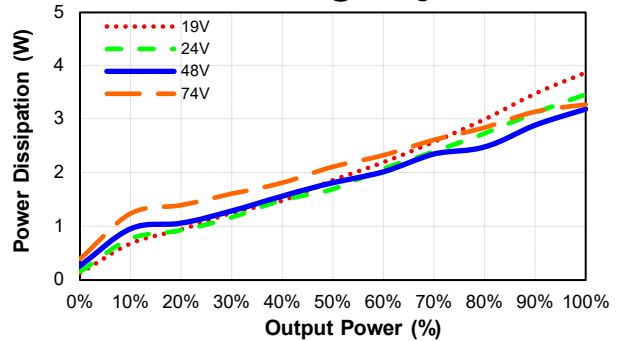

EC5SBW-48S05-CMF
Eff Vs Io @25 Deg. C

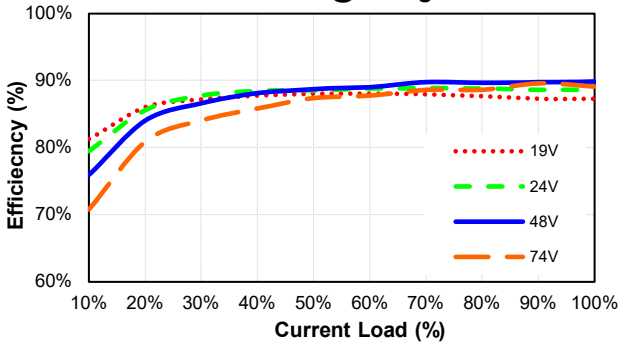

EC5SBW-48S05-CMF
Pd Vs Po @25 Deg. C

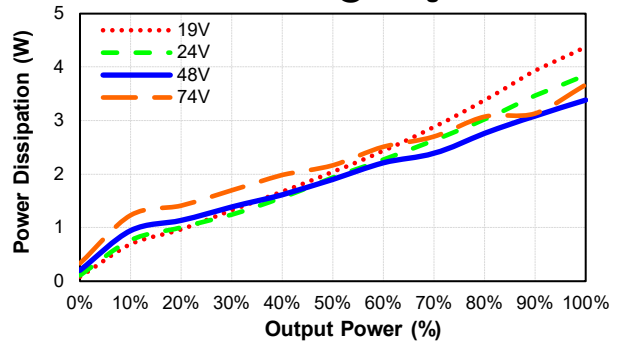



EC5SBW-C(D)MF Series

EC5SBW-48S12-CMF
Eff Vs Io @25 Deg. C

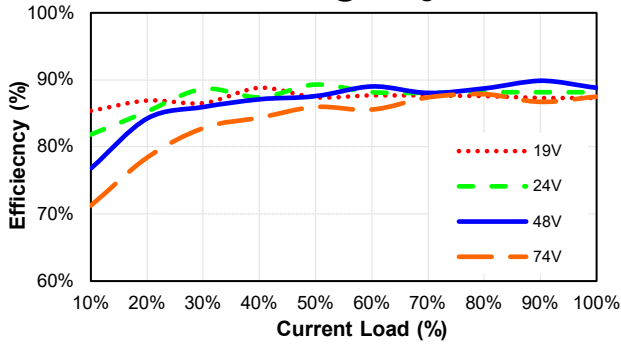

EC5SBW-48S12-CMF
Pd Vs Po @25 Deg. C

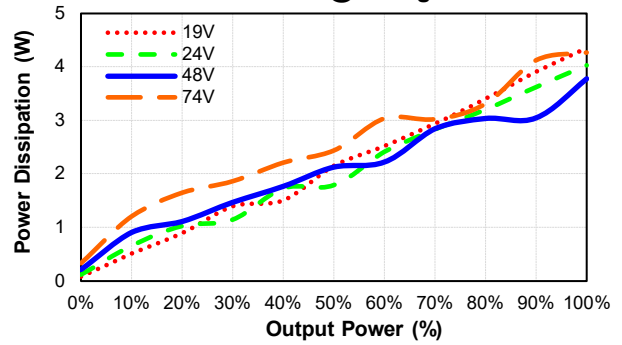

EC5SBW-48S15-CMF
Eff Vs Io @25 Deg. C

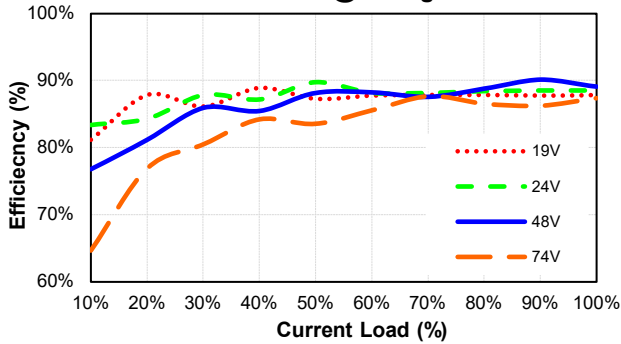

EC5SBW-48S15-CMF
Pd Vs Po @25 Deg. C

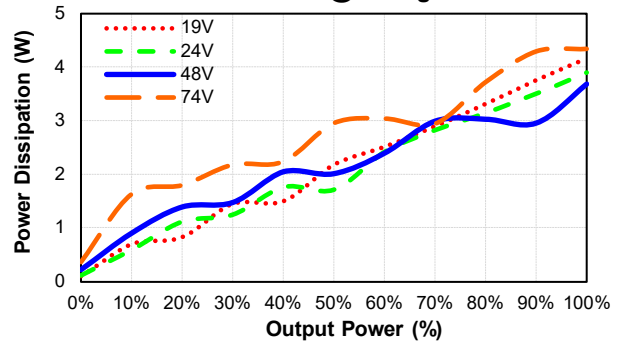

EC5SBW-48D12-CMF
Eff Vs Io @25 Deg. C

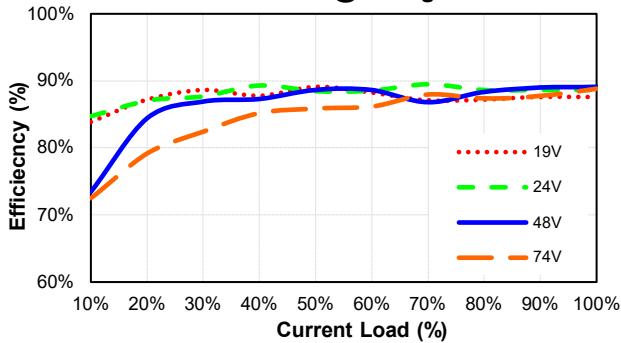

EC5SBW-48D12-CMF
Pd Vs Po @25 Deg. C

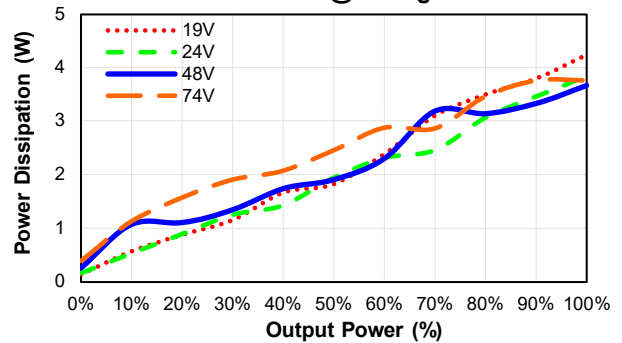

EC5SBW-48D15-CMF
Eff Vs Io @25 Deg. C

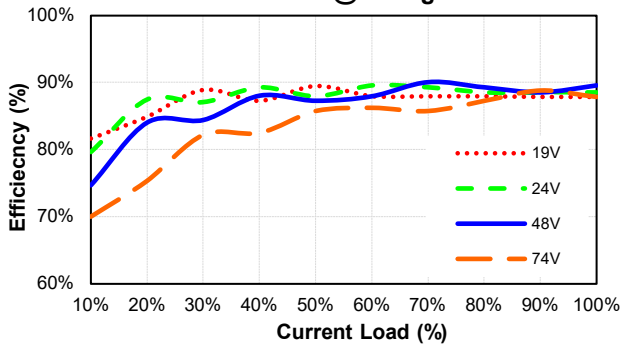

EC5SBW-48D15-CMF
Pd Vs Po @25 Deg. C

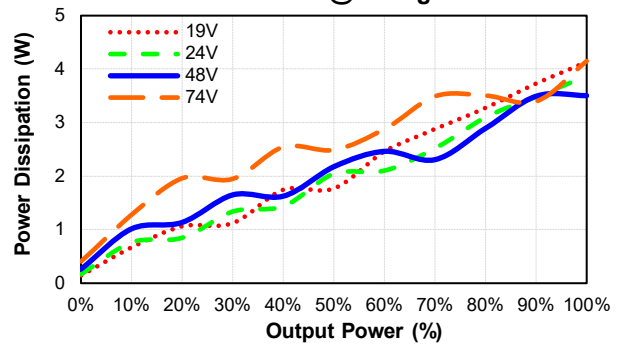



EC5SBW-C(D)MF Series

MECHANICAL SPECIFICATION

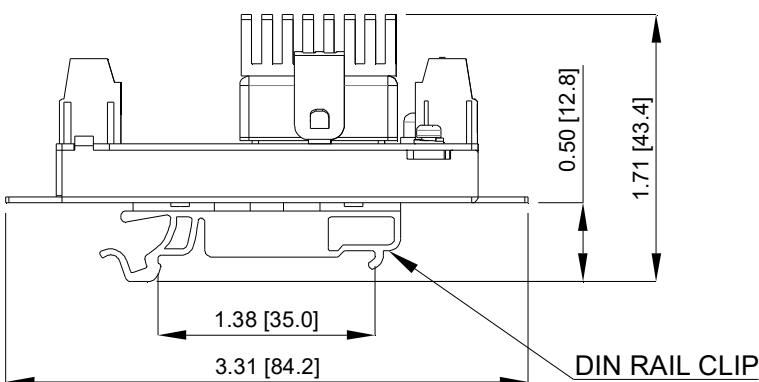
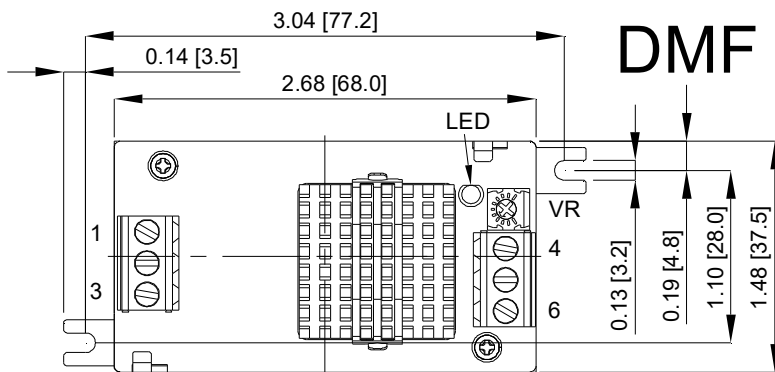
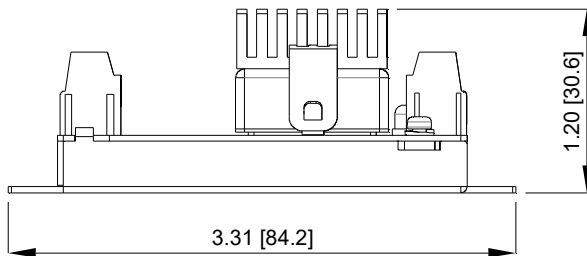
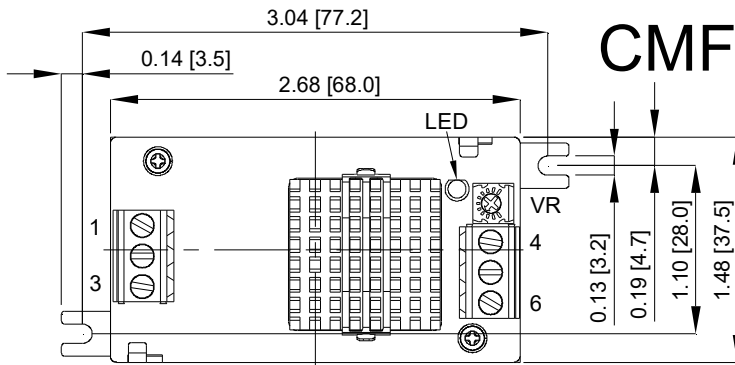

PIN CONNECTION		
Pin	Single	Dual
1	Remote	Remote
2	-Vin	-Vin
3	+Vin	+Vin
4	-Vout	-Vout
5	Trim	Common
6	+Vout	+Vout
VR	Yes	No

All Dimensions in Inches[mm]
 Tolerance Inches: x.xx=±0.02, x.xxx=±0.010
 Millimeters: x.x=±0.5, x.xx=±0.25

CINCON Electronics Co. Ltd.
 Add: 14F, No. 306, Sec.4, Hsin Yi Rd., Taipei, Taiwan
 Tel: 886-2-27086210
 Fax: 886-2-27029852
 E-mail: sales@cincon.com.tw
 Web: www.cincon.com