

PE43711

Product Specification

UltraCMOS® RF Digital Step Attenuator, 9 kHz–6 GHz



Features

- Flexible attenuation steps of 0.25 dB, 0.5 dB and 1 dB up to 31.75 dB
- Glitch-less attenuation state transitions
- Monotonicity: 0.25 dB up to 4GHz, 0.5 dB up to 5 GHz and 1 dB up to 6 GHz
- Extended +105 °C operating temperature
- Parallel and Serial programming interfaces
- Packaging—24-lead 4 × 4 mm QFN

Applications

- 3G/4G wireless infrastructure
- Land mobile radio (LMR) system
- Point-to-point communication system

Figure 1 • PE43711 Functional Diagram

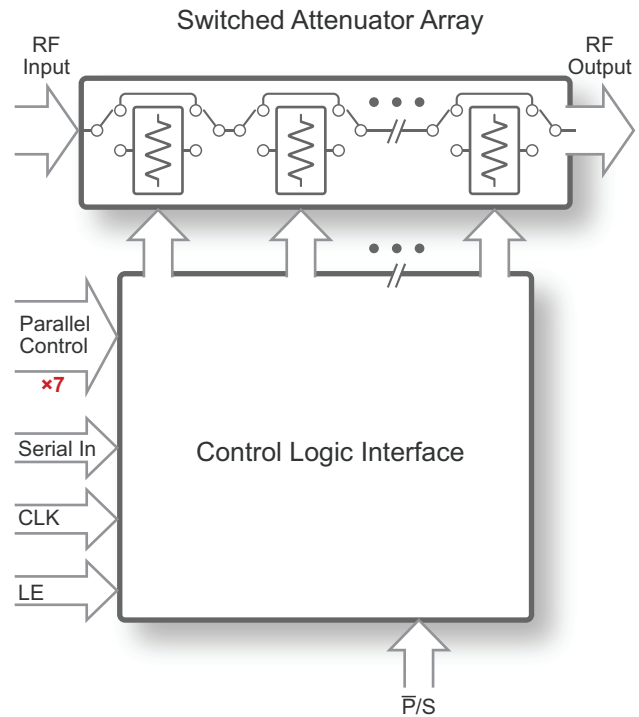

Product Description

The PE43711 is a 50Ω, HaRP™ technology-enhanced, 7-bit RF digital step attenuator (DSA) that supports a broad frequency range from 9 kHz to 6 GHz. It features glitch-less attenuation state transitions and supports 1.8V control voltage and an extended operating temperature range to +105 °C, making this device ideal for many broadband wireless applications.

The PE43711 is a pin-compatible upgraded version of the PE43502, PE43503, PE43602 and PE43702. An integrated digital control interface supports both Serial and Parallel programming of the attenuation, including the capability to program an initial attenuation state at power-up.

The PE43711 covers a 31.75 dB attenuation range in 0.25 dB, 0.5 dB and 1 dB steps. It is capable of maintaining 0.25 dB monotonicity through 4 GHz, 0.5 dB monotonicity through 5 GHz and 1 dB monotonicity through 6 GHz. In addition, no external blocking capacitors are required if 0 VDC is present on the RF ports.

The PE43711 is manufactured on pSemi's UltraCMOS® process, a patented variation of silicon-on-insulator (SOI) technology on a sapphire substrate.

pSemi's HaRP technology enhancements deliver high linearity and excellent harmonics performance. It is an innovative feature of the UltraCMOS process, offering the performance of GaAs with the economy and integration of conventional CMOS.

Absolute Maximum Ratings

Exceeding absolute maximum ratings listed in **Table 1** may cause permanent damage. Operation should be restricted to the limits in **Table 2**. Operation between operating range maximum and absolute maximum for extended periods may reduce reliability.

ESD Precautions

When handling this UltraCMOS device, observe the same precautions as with any other ESD-sensitive devices. Although this device contains circuitry to protect it from damage due to ESD, precautions should be taken to avoid exceeding the rating specified in **Table 1**.

Latch-up Immunity

Unlike conventional CMOS devices, UltraCMOS devices are immune to latch-up.

Table 1 • Absolute Maximum Ratings for PE43711

Parameter/Condition	Min	Max	Unit
Supply voltage, V_{DD}	-0.3	5.5	V
Digital input voltage	-0.3	3.6	V
RF input power, 50Ω 9 kHz–48 MHz >48 MHz–6 GHz		Figure 5 +31	dBm dBm
Storage temperature range	-65	+150	°C
ESD voltage HBM, all pins ⁽¹⁾		3000	V
ESD voltage CDM, all pins ⁽²⁾		1000	V
Notes: 1) Human body model (MIL-STD 883 Method 3015). 2) Charged device model (JEDEC JESD22-C101).			

Recommended Operating Conditions

Table 2 lists the recommending operating condition for the PE43711. Devices should not be operated outside the recommended operating conditions listed below.

Table 2 • Recommended Operating Condition for PE43711

Parameter	Min	Typ	Max	Unit
Supply voltage, V_{DD}	2.3		5.5	V
Supply current, I_{DD}		150	200	μ A
Digital input high	1.17		3.6	V
Digital input low	-0.3		0.6	V
Digital input current			17.5	μ A
RF input power, CW ⁽¹⁾ 9 kHz–48 MHz >48 MHz–6 GHz			Figure 5 +23	dBm dBm
RF input power, pulsed ⁽²⁾ 9 kHz–48 MHz >48 MHz–6 GHz			Figure 5 +28	dBm dBm
Operating temperature range	-40	+25	+105	°C
Notes:				
1) 100% duty cycle, all bands, 50 Ω .				
2) Pulsed, 5% duty cycle of 4620 μ s period, 50 Ω .				

Electrical Specifications

Table 3 provides the PE43711 key electrical specifications at 25 °C, $V_{DD} = 3.3V$, $RF1 = RF_{IN}$, $RF2 = RF_{OUT}$ ($Z_S = Z_L = 50\Omega$), unless otherwise specified.

Table 3 • PE43711 Electrical Specifications

Parameter	Condition	Frequency	Min	Typ	Max	Unit
Operating frequency			9 kHz		6 GHz	As shown
Attenuation range	0.25 dB step			0–31.75		dB
	0.5 dB step			0–31.50		dB
	1 dB step			0–31.00		dB
Insertion loss		9 kHz–1.0 GHz		1.3	1.5	dB
		1.0–2.2 GHz		1.6	1.85	dB
		2.2–4.0 GHz		1.9	2.4	dB
		4.0–6.0 GHz		2.4	2.8	dB
Attenuation error	0.25 dB step					
	0–31.75 dB	9 kHz–2.2 GHz			$\pm(0.15 + 1.5\%$ of attenuation setting)	dB
	0–31.75 dB	>2.2–3.0 GHz			$\pm (0.15 + 2.5\%$ of attenuation setting)	dB
	0–31.75 dB	>3.0–4.0 GHz			$\pm (0.25 + 3.5\%$ of attenuation setting)	dB
	0.5 dB step					
	0–31.5 dB	9 kHz–2.2 GHz			$\pm (0.15 + 1.5\%$ of attenuation setting)	dB
	0–31.5 dB	>2.2–3.0 GHz			$\pm (0.15 + 2.5\%$ of attenuation setting)	dB
	0–31.5 dB	>3.0–5.0 GHz			$\pm (0.25 + 3.5\%$ of attenuation setting)	dB
	1 dB step					
	0–31 dB	9 kHz–2.2 GHz			$\pm (0.15 + 1.5\%$ of attenuation setting)	dB
	0–31 dB	>2.2–3.0 GHz			$\pm (0.15 + 2.5\%$ of attenuation setting)	dB
	0–31 dB	>3.0–5.0 GHz			$\pm (0.25 + 3.5\%$ of attenuation setting)	dB
	0–31 dB	>5.0–6.0 GHz			$\pm (0.25 + 6.0\%$ of attenuation setting)	dB
Return loss	Input port or output port	9 kHz–4 GHz		14		dB
		4–6 GHz		16		dB

Table 3 • PE43711 Electrical Specifications (Cont.)

Parameter	Condition	Frequency	Min	Typ	Max	Unit
Relative phase	All states	9 kHz–4 GHz 4–6 GHz		31 48		deg deg
Input 0.1dB compression point ^(*)		48 MHz–6 GHz		31		dBm
Input IP3	Two tones at +18 dBm, 20 MHz spacing	4 GHz 6 GHz		57 56		dBm dBm
RF T _{rise} /T _{fall}	10%/90% RF			200		ns
Settling time	RF settled to within 0.05 dB of final value			1.6		μs
Switching time	50% CTRL to 90% or 10% RF			275		ns
Attenuation transient (envelope)		2 GHz		0.3		dB

Note: * The input 0.1dB compression point is a linearity figure of merit. Refer to Table 2 for the operating RF input power (50Ω).

Switching Frequency

The PE43711 has a maximum 25 kHz switching rate.

Switching frequency is defined to be the speed at which the DSA can be toggled across attenuation states. Switching time is the time duration between the point the control signal reaches 50% of the final value and the point the output signal reaches within 10% or 90% of its target value.

Spurious Performance

The typical spurious performance of the PE43711 is -130 dBm.

Glitch-less Attenuation State Transitions

The PE43711 features a novel architecture to provide the best-in-class glitch-less transition behavior when changing attenuation states. When RF input power is applied, the output power spikes are greatly reduced (≤ 0.3 dB) during attenuation state changes when comparing to previous generations of DSAs.

Truth Tables

Table 4–Table 5 provide the truth tables for the PE43711.

Table 4 • Parallel Truth Table

Parallel Control Setting							Attenuation Setting RF1–RF2
D6	D5	D4	D3	D2	D1	D0	
L	L	L	L	L	L	L	Reference IL
L	L	L	L	L	L	H	0.25 dB
L	L	L	L	L	H	L	0.5 dB
L	L	L	L	H	L	L	1 dB
L	L	L	H	L	L	L	2 dB
L	L	H	L	L	L	L	4 dB
L	H	L	L	L	L	L	8 dB
H	L	L	L	L	L	L	16 dB
H	H	H	H	H	H	H	31.75 dB

Table 5 • Serial Attenuation Word Truth Table

Attenuation Word								Attenuation Setting RF1–RF2
D7	D6	D5	D4	D3	D2	D1	D0 (LSB)	
L	L	L	L	L	L	L	L	Reference IL
L	L	L	L	L	L	L	H	0.25 dB
L	L	L	L	L	L	H	L	0.5 dB
L	L	L	L	L	H	L	L	1 dB
L	L	L	L	H	L	L	L	2 dB
L	L	L	H	L	L	L	L	4 dB
L	L	H	L	L	L	L	L	8 dB
L	H	L	L	L	L	L	L	16 dB
L	H	H	H	H	H	H	H	31.75 dB

Serial Register Map

Figure 2 provides the Serial register map for the PE43711.

Figure 2 • *Serial Register Map*

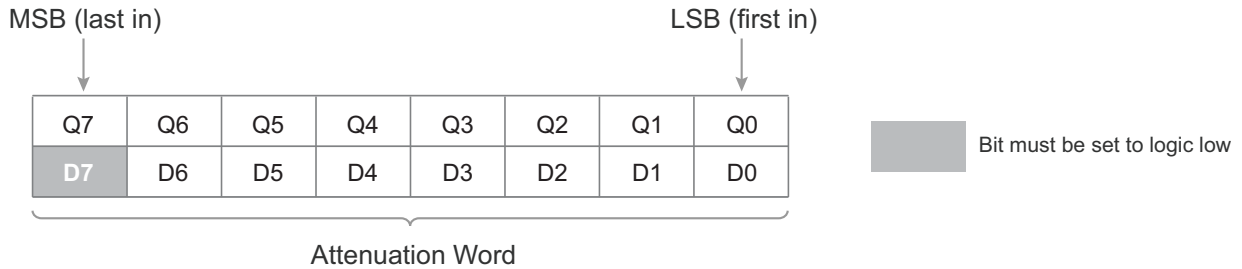

The attenuation word is derived directly from the value of the attenuation state. To find the attenuation word, multiply the value of the state by four, then convert to binary.

For example, to program the 12.5 dB state:

$$4 \times 12.5 = 50$$

$$50 \rightarrow 00110010$$

Serial Input: 00110010

Programming Options

Parallel/Serial Selection

Either a Parallel or Serial interface can be used to control the PE43711. The $\overline{P/S}$ bit provides this selection, with $\overline{P/S} = \text{LOW}$ selecting the Parallel interface and $\overline{P/S} = \text{HIGH}$ selecting the Serial interface.

Parallel Mode Interface

The Parallel interface consists of seven CMOS-compatible control lines that select the desired attenuation state, as shown in **Table 4**.

The Parallel interface timing requirements are defined by **Figure 4** (Parallel Interface Timing Diagram), **Table 8** (Parallel and Direct Interface AC Characteristics) and switching time (**Table 3**).

For Latched Parallel programming, the Latch Enable (LE) should be held LOW while changing attenuation state control values then pulse LE HIGH to LOW (per **Figure 4**) to latch new attenuation state into the device.

For Direct Parallel programming, the LE line should be pulled HIGH. Changing attenuation state control values will change device state to new attenuation. Direct mode is ideal for manual control of the device (using hardwire, switches or jumpers).

Serial Interface

The Serial interface is an 8-bit Serial-In, Parallel-Out shift register buffered by a transparent latch. The 8-bits make up the Attenuation Word that controls the DSA. **Figure 3** illustrates an example timing diagram for programming a state.

The Serial interface is controlled using three CMOS-compatible signals: SI, Clock (CLK) and LE. The SI and CLK inputs allow data to be serially entered into the shift register. Serial data is clocked in LSB first.

The shift register must be loaded while LE is held LOW to prevent the attenuator value from changing as data is entered. The LE input should then be toggled HIGH and brought LOW again, latching the new data into the DSA. The Attenuation Word truth table is listed in **Table 5**. A programming example of the serial register is illustrated in **Figure 2**. The Serial timing diagram is illustrated in **Figure 3**. It is required

that all Parallel control inputs be grounded when the DSA is used in Serial mode.

Power-up Control Settings

The PE43711 will always initialize to the maximum attenuation setting (31.75 dB) on power-up for both the Serial and Latched Parallel modes of operation and will remain in this setting until the user latches in the next programming word. In Direct Parallel mode, the DSA can be preset to any state within the 31.75 dB range by pre-setting the Parallel control pins prior to power-up. In this mode, there is a 400 μs delay between the time the DSA is powered-up to the time the desired state is set. During this power-up delay, the device attenuates to the maximum attenuation setting (31.75 dB) before defaulting to the user defined state. If the control pins are left floating in this mode during power-up, the device will default to the minimum attenuation setting (insertion loss state).

Dynamic operation between Serial and Parallel programming modes is possible.

If the DSA powers up in Serial mode ($\overline{P/S} = \text{HIGH}$), all the Parallel control inputs DI[6:0] must be set to logic LOW. Prior to toggling to Parallel mode, the DSA must be programmed serially to ensure D[7] is set to logic LOW.

If the DSA powers up in either Latched or Direct Parallel mode, all Parallel pins DI[6:0] must be set to logic LOW prior to toggling to Serial mode ($\overline{P/S} = \text{HIGH}$), and held LOW until the DSA has been programmed serially to ensure bit D[7] is set to logic LOW.

The sequencing is only required once on power-up. Once completed, the DSA may be toggled between Serial and Parallel programming modes at will.

Figure 3 • Serial Timing Diagram

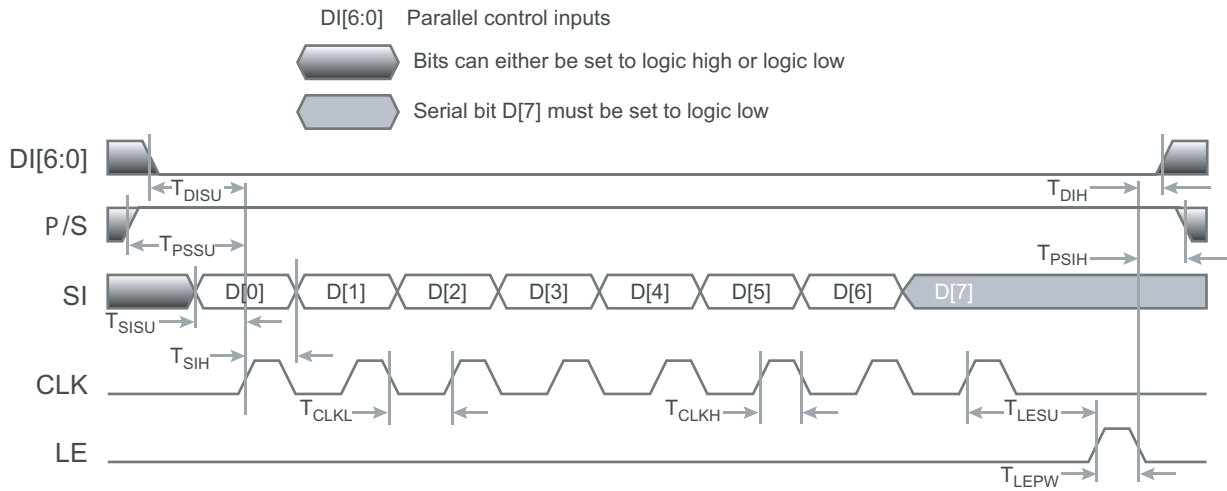

Figure 4 • Latched Parallel/Direct Parallel Timing Diagram

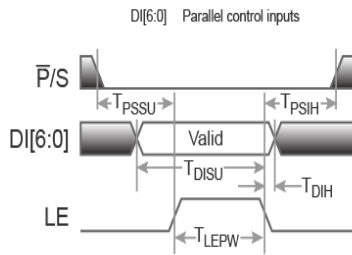

Table 6 • Latch and Clock Specifications

Latch Enable	Shift Clock	Function
0	↑	Shift register clocked
↑	X	Contents of shift register transferred to attenuator core

Table 7 • Serial Interface AC Characteristics^(*)

Parameter/Condition	Min	Max	Unit
Serial clock frequency, F_{CLK}		10	MHz
Serial clock HIGH time, T_{CLKH}	30		ns
Serial clock LOW time, T_{CLKL}	30		ns
Last Serial clock rising edge setup time to Latch Enable rising edge, T_{LESU}	10		ns
Latch Enable minimum pulse width, T_{LEPW}	30		ns
Serial data setup time, T_{SISU}	10		ns
Serial data hold time, T_{SIH}	10		ns
Parallel data setup time, T_{DISU}	100		ns
Parallel data hold time, T_{DIH}	100		ns
Address setup time, T_{ASU}	100		ns
Address hold time, T_{AH}	100		ns
Parallel/Serial setup time, T_{PSSU}	100		ns
Parallel/Serial hold time, T_{PSIH}	100		ns
Note: * $V_{DD} = 3.3V$ or $5.0V$, $-40\text{ }^{\circ}\text{C} < T_A < +105\text{ }^{\circ}\text{C}$, unless otherwise specified.			

Table 8 • Parallel and Direct Interface AC Characteristics^(*)

Parameter/Condition	Min	Max	Unit
Latch Enable minimum pulse width, T_{LEPW}	30		ns
Parallel data setup time, T_{DISU}	100		ns
Parallel data hold time, T_{DIH}	100		ns
Parallel/Serial setup time, T_{PSSU}	100		ns
Parallel/Serial hold time, T_{PSIH}	100		ns
Note: * $V_{DD} = 3.3V$ or $5.0V$, $-40\text{ }^{\circ}\text{C} < T_A < +105\text{ }^{\circ}\text{C}$, unless otherwise specified.			

Figure 5 • Power De-rating Curve, 9 kHz–6 GHz, –40 to +105 °C Ambient, 50Ω

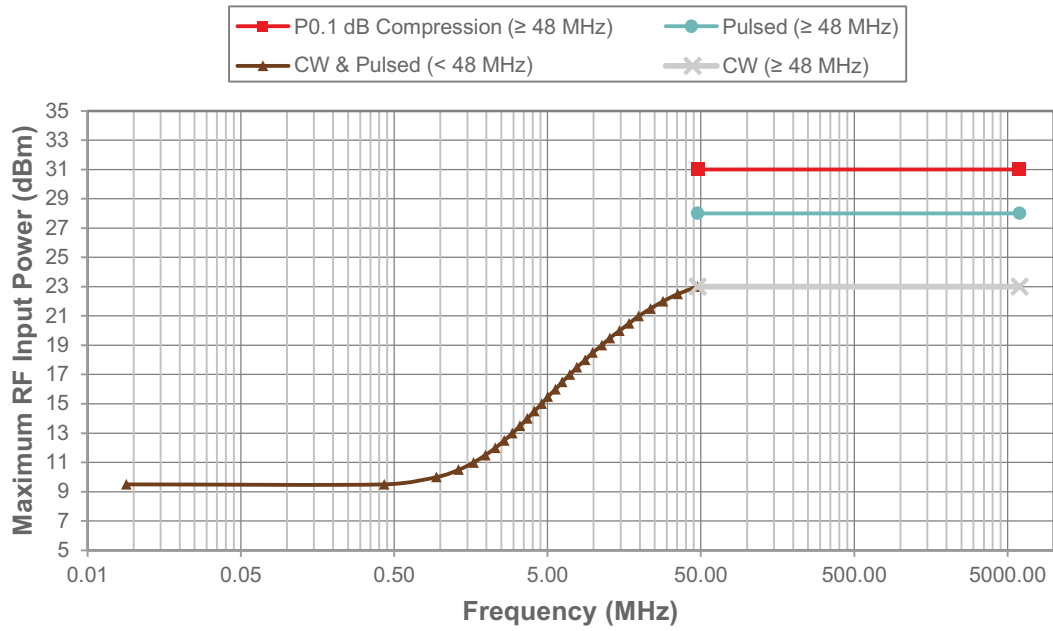

Typical Performance Data

Figure 6–Figure 32 show the typical performance data at 25 °C and $V_{DD} = 3.3V$, $RF1 = RF_{IN}$, $RF2 = RF_{OUT}$ ($Z_S = Z_L = 50\Omega$) unless otherwise specified.

Figure 6 • Insertion Loss vs Temperature

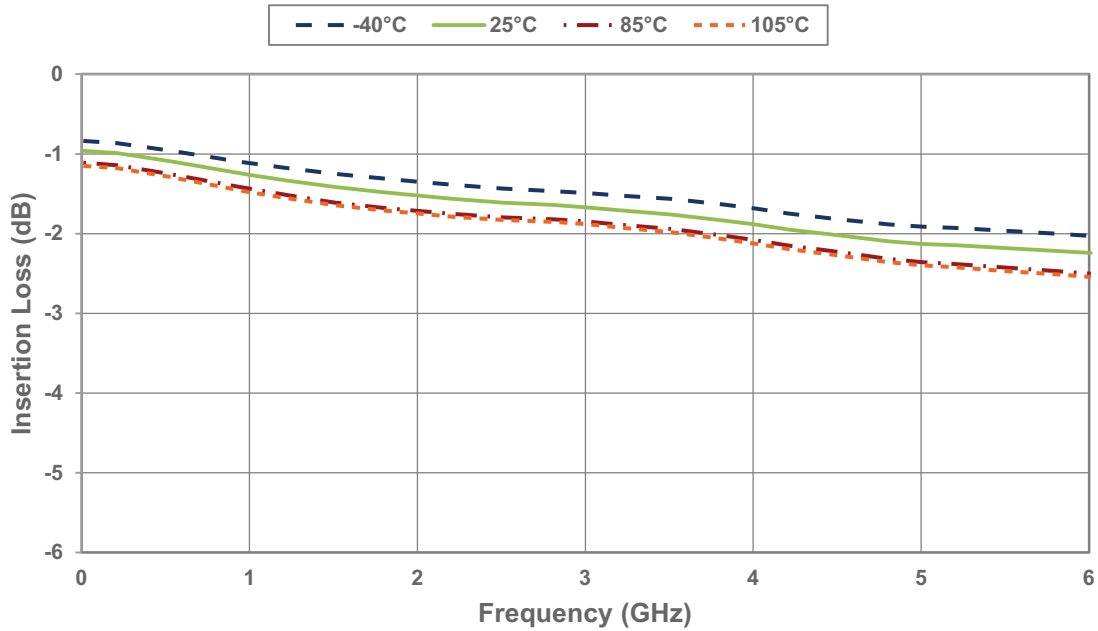

Figure 7 • *Input Return Loss vs Attenuation Setting*

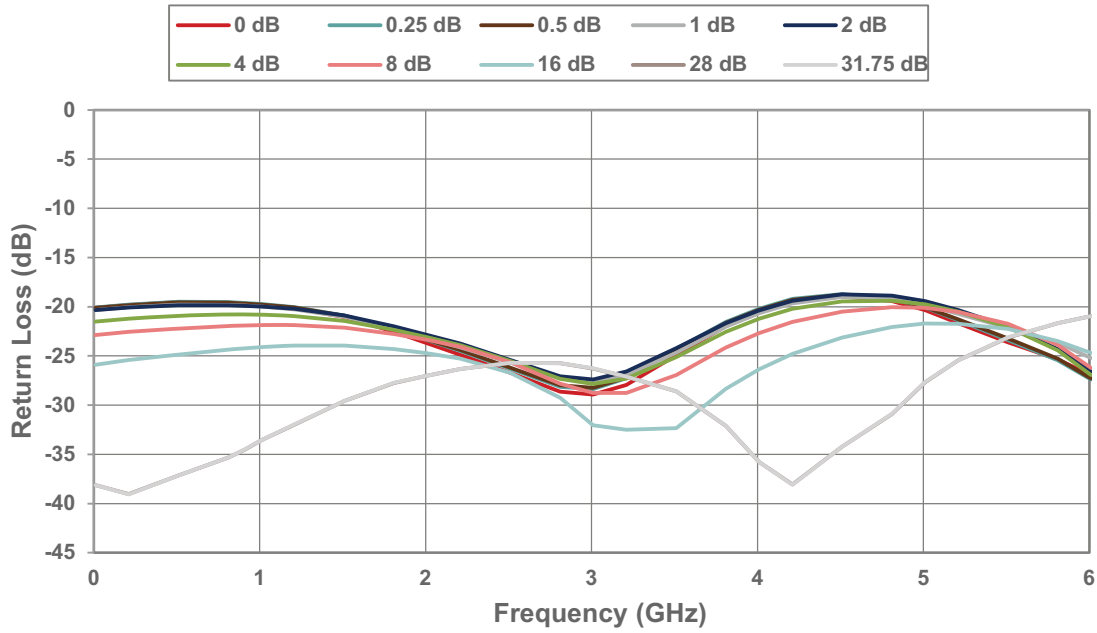

Figure 8 • *Output Return Loss vs Attenuation Setting*

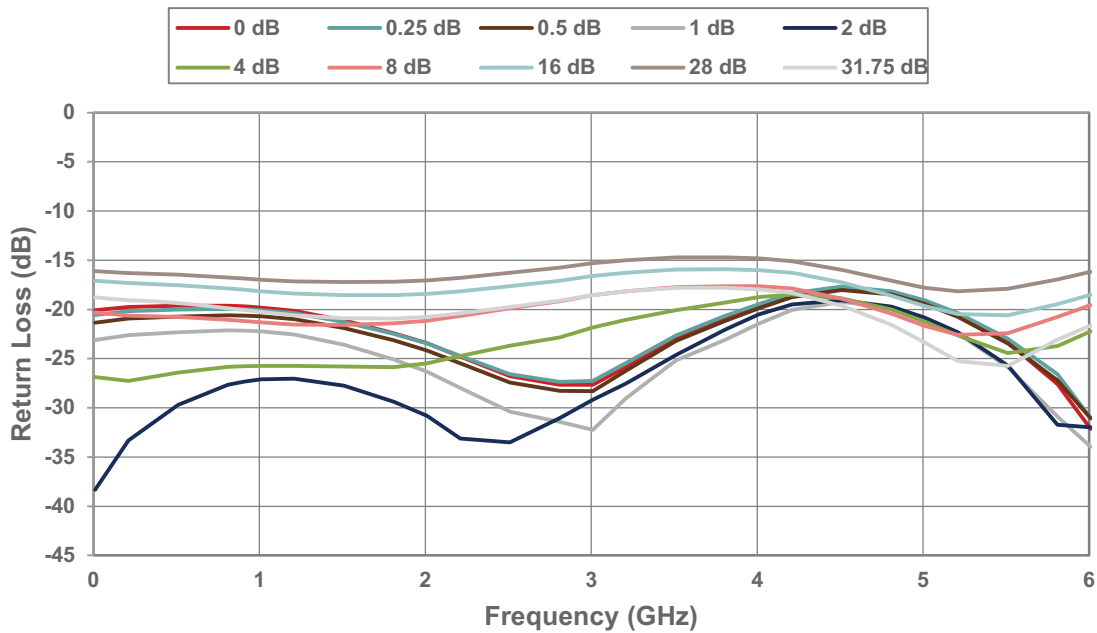

Figure 9 • Input Return Loss for 16 dB Attenuation Setting vs Temperature

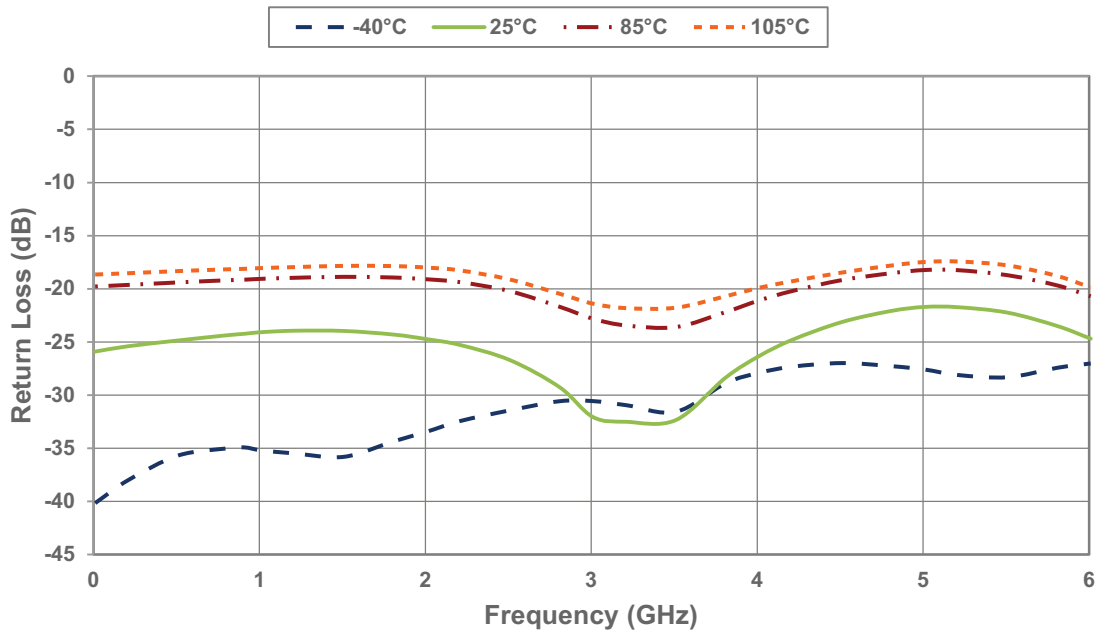

Figure 10 • Output Return Loss for 16 dB Attenuation Setting vs Temperature

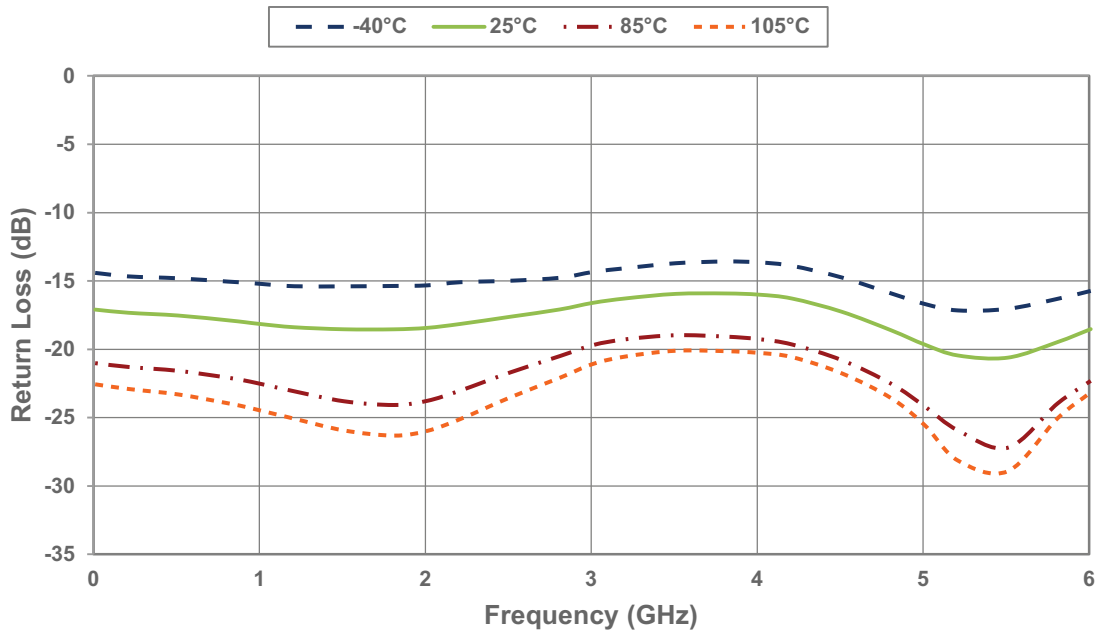

Figure 11 • Relative Phase Error vs Attenuation Setting

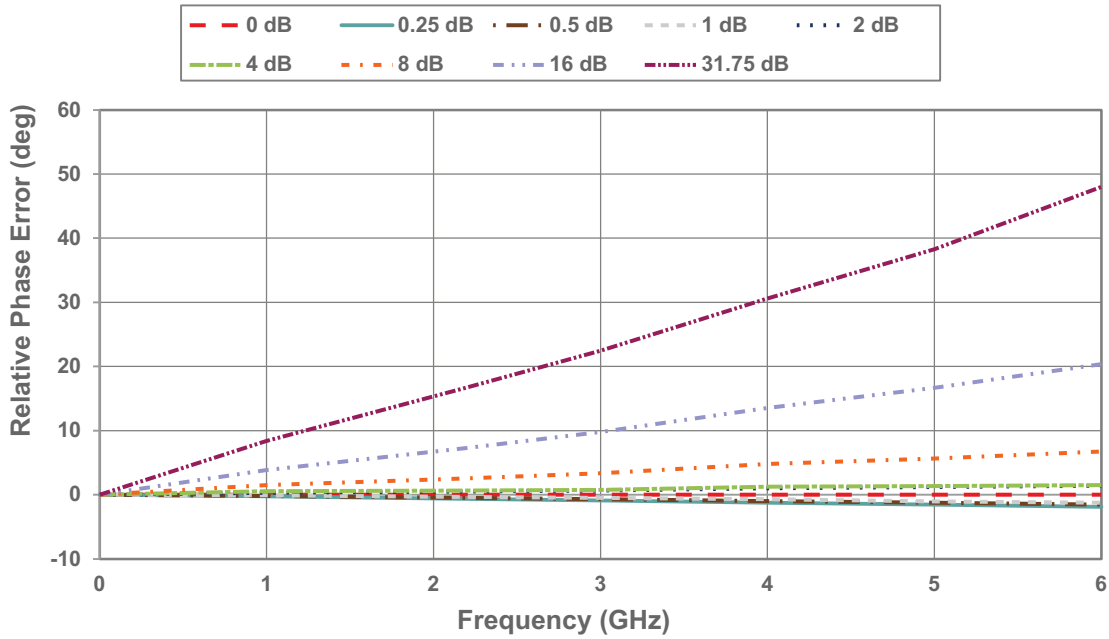

Figure 12 • Relative Phase Error for 31.75 dB Attenuation Setting vs Frequency

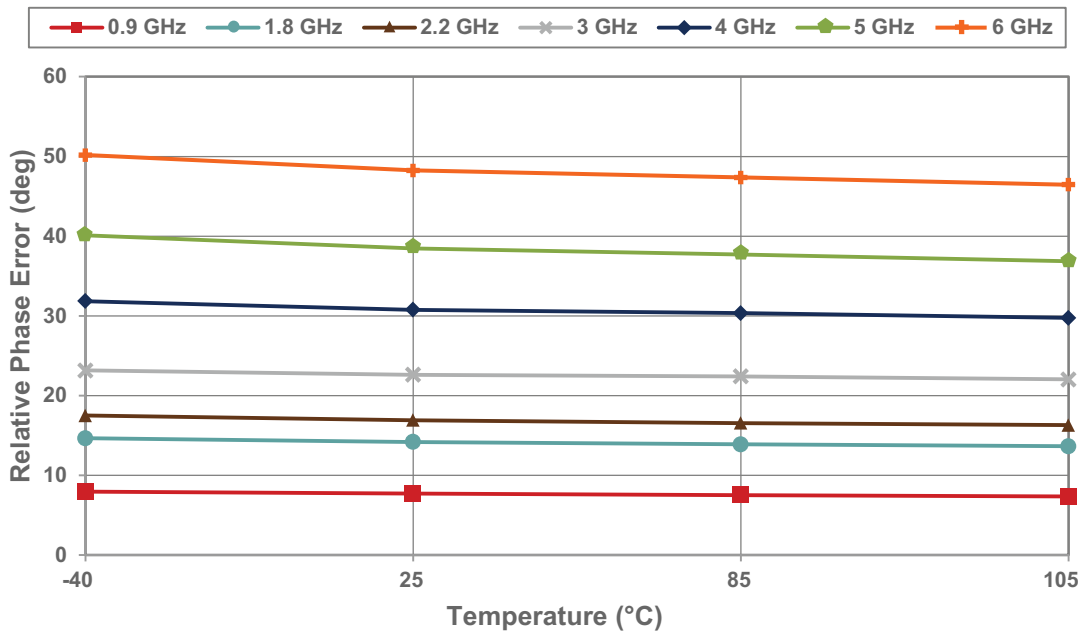

Figure 13 • Attenuation Error @ 900 MHz vs Temperature

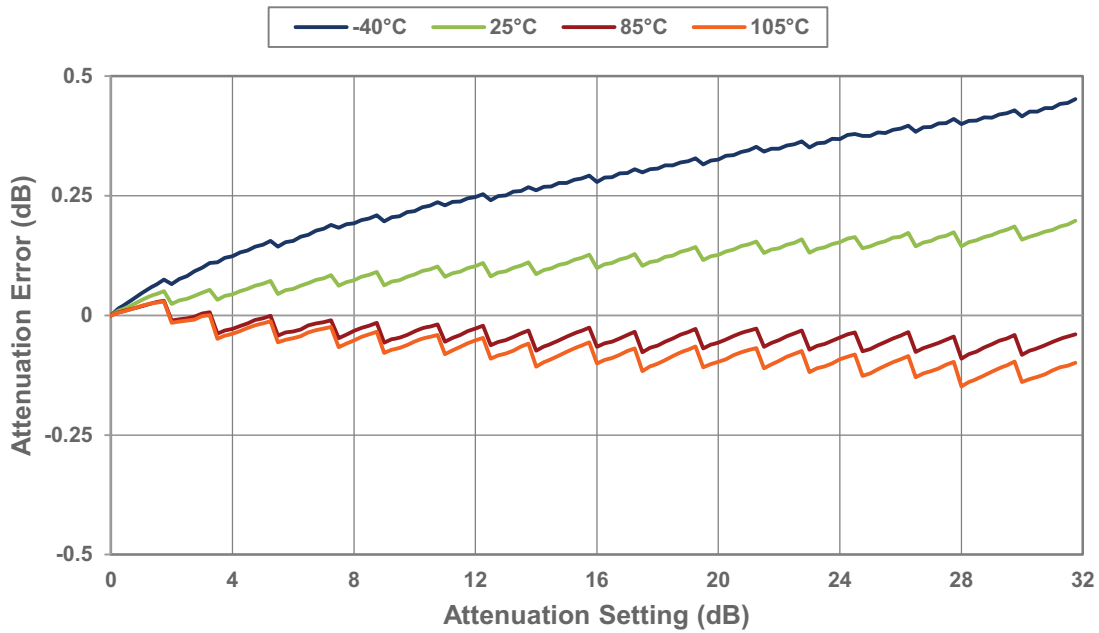

Figure 14 • Attenuation Error @ 1800 MHz vs Temperature

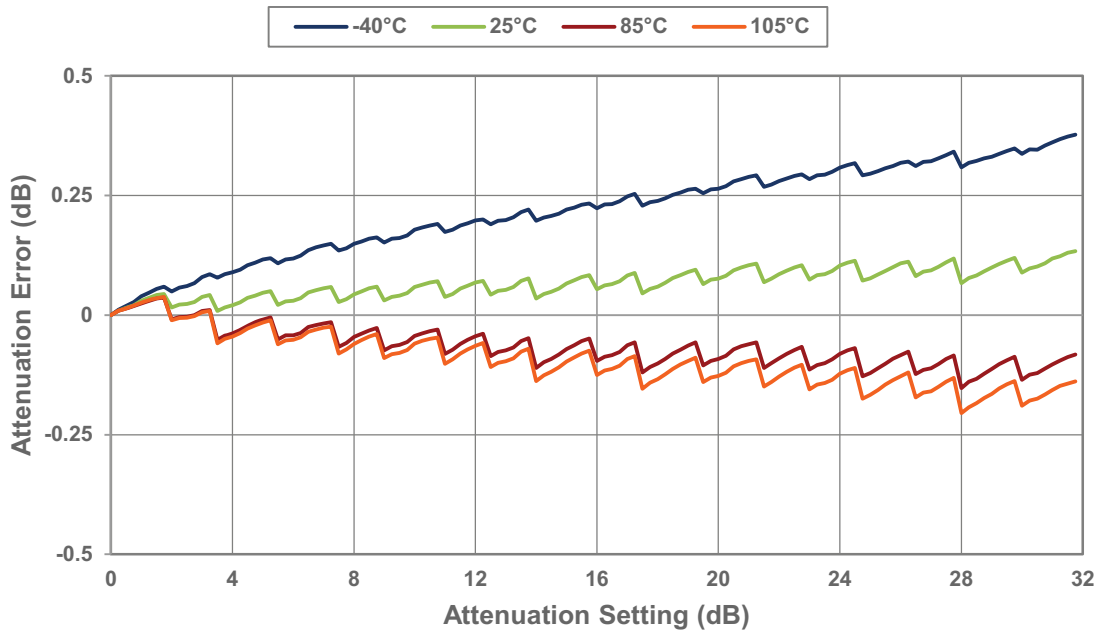

Figure 15 • Attenuation Error @ 2200 MHz vs Temperature

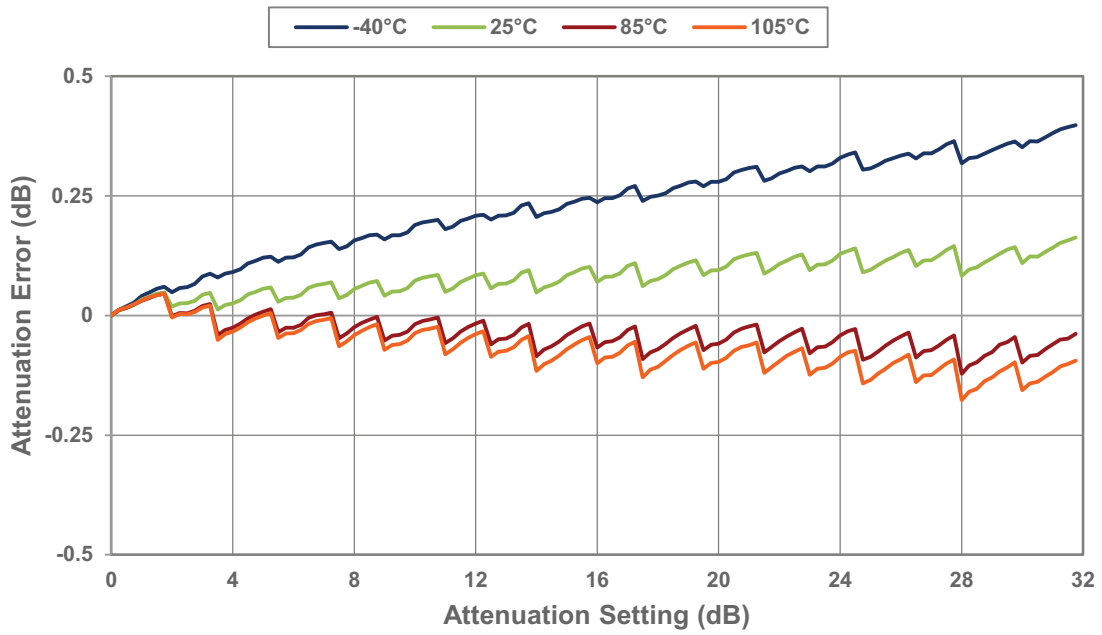

Figure 16 • Attenuation Error @3000 MHz vs Temperature

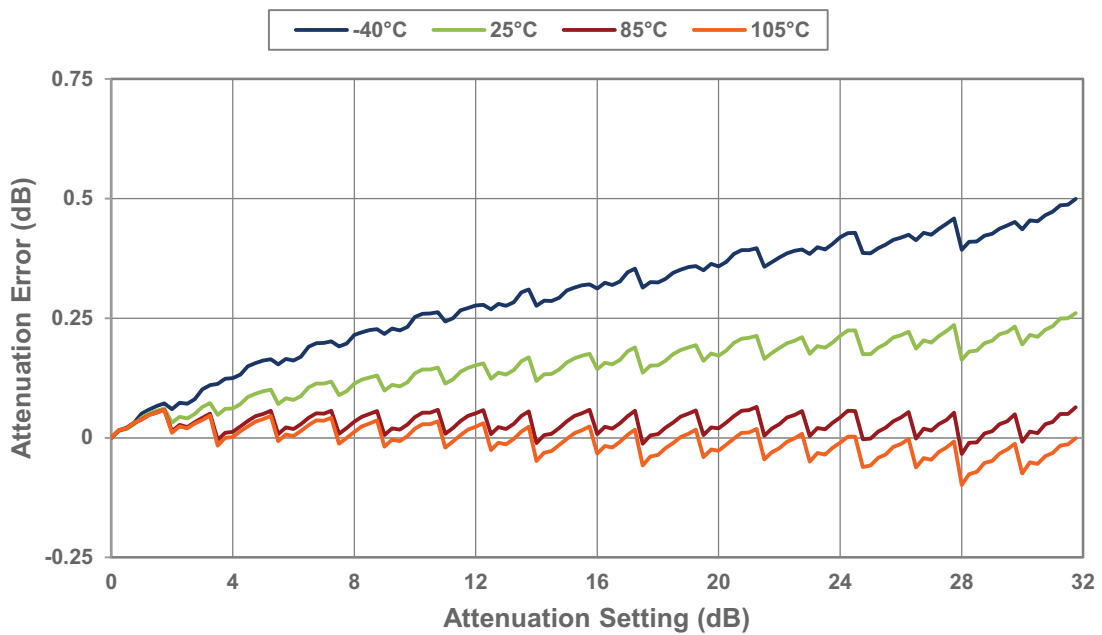

Figure 17 • Attenuation Error @ 4000 MHz vs Temperature

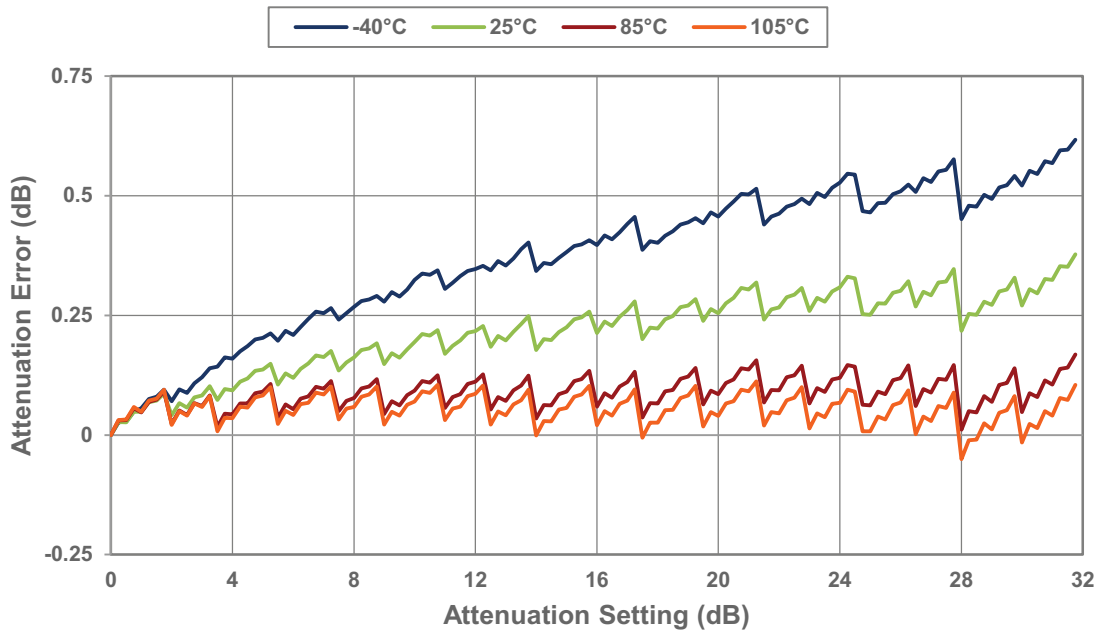

Figure 18 • IIP3 vs Attenuation Setting

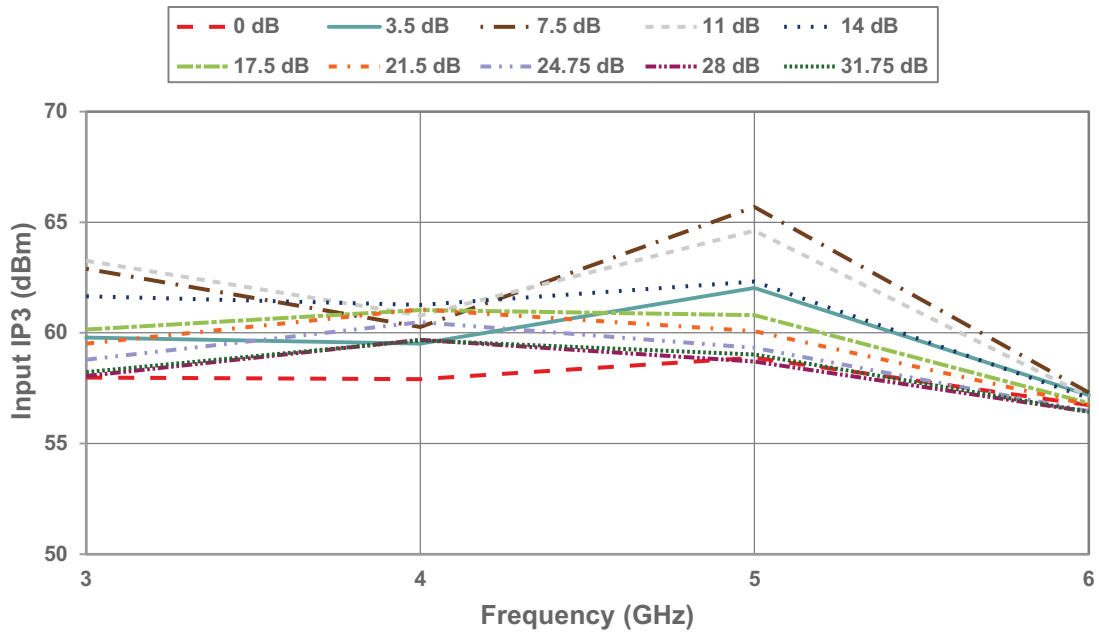
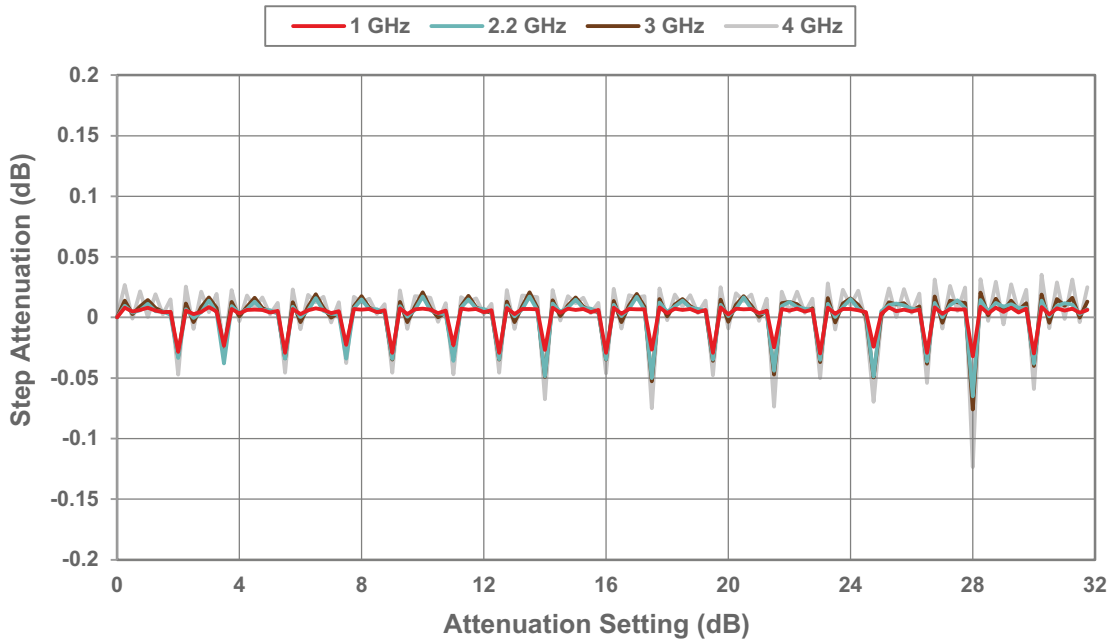

Figure 19 • 0.25 dB Step Attenuation vs Frequency^(*)



Note: * Monotonicity is held so long as step attenuation does not cross below -0.25 dB.

Figure 20 • 0.25 dB Step, Actual vs Frequency

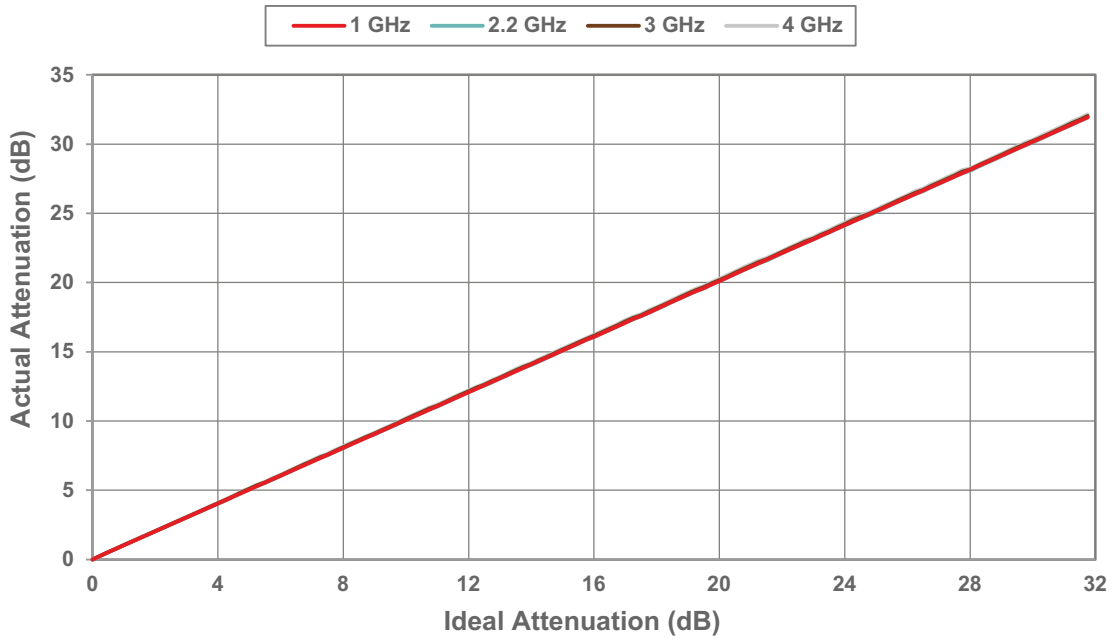

Figure 21 • 0.25 dB Major State Bit Error vs Attenuation Setting

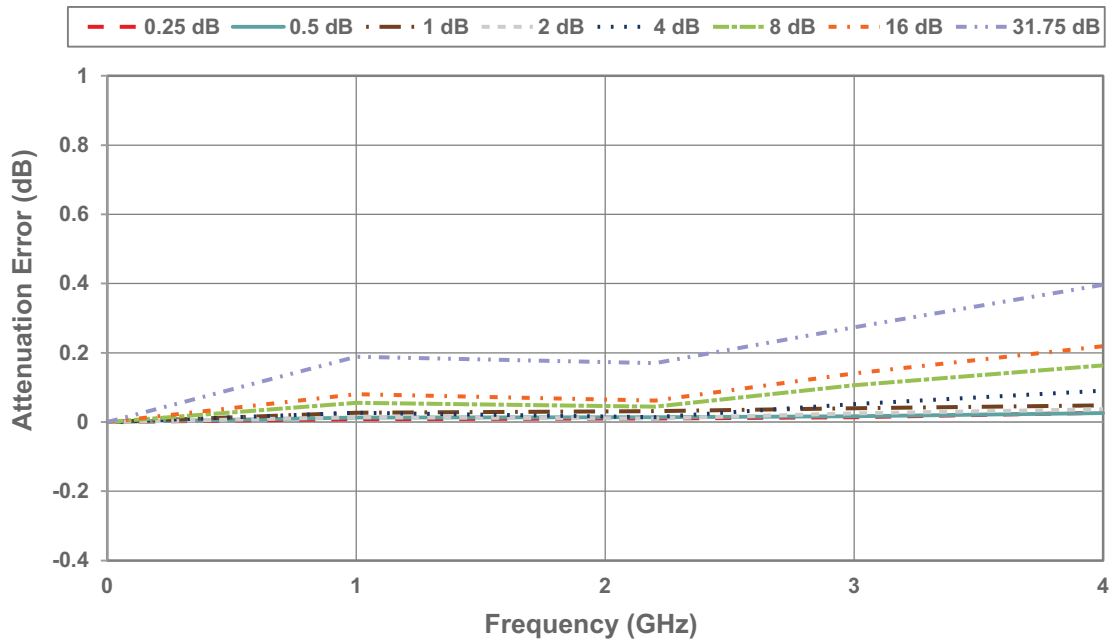

Figure 22 • 0.25 dB Attenuation Error vs Frequency

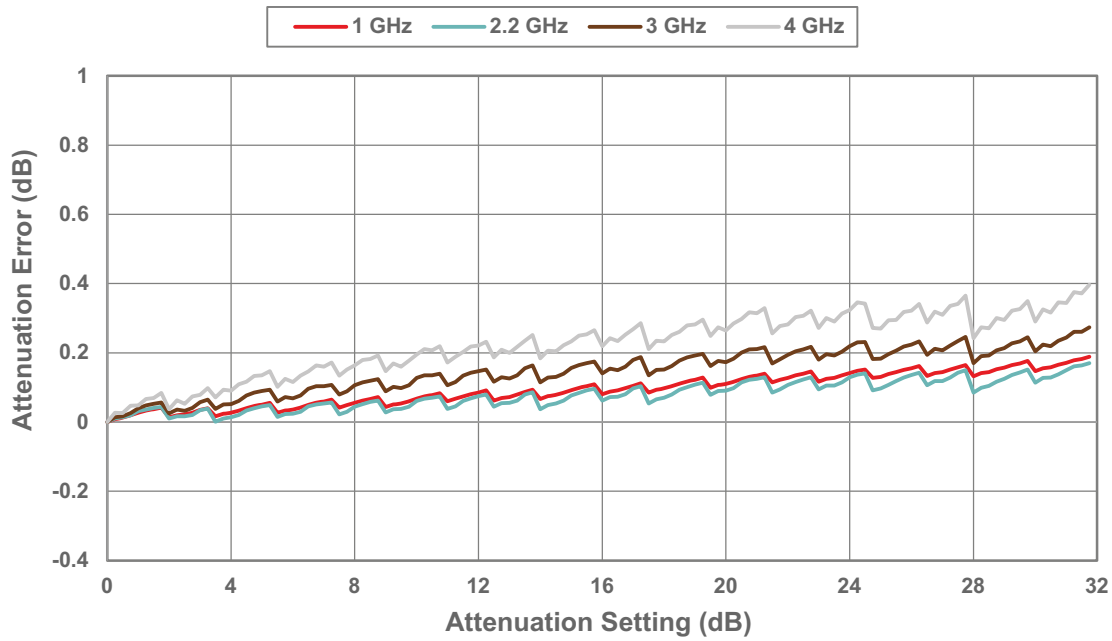
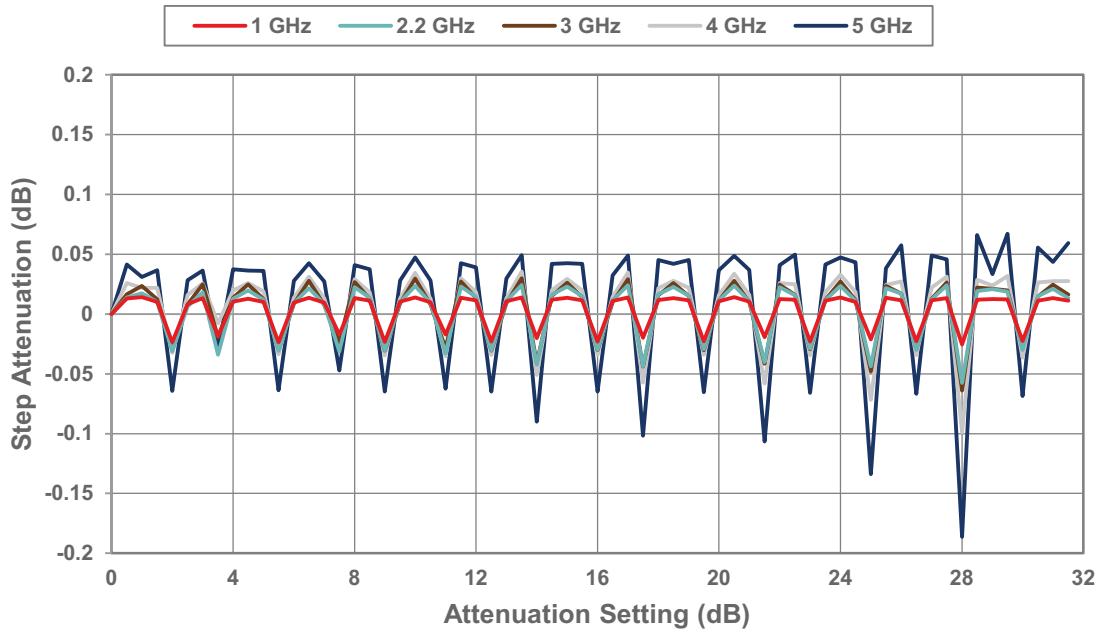

Figure 23 • 0.5 dB Step Attenuation vs Frequency^(*)



Note: * Monotonicity is held so long as step attenuation does not cross below -0.5 dB.

Figure 24 • 0.5 dB Step, Actual vs Frequency

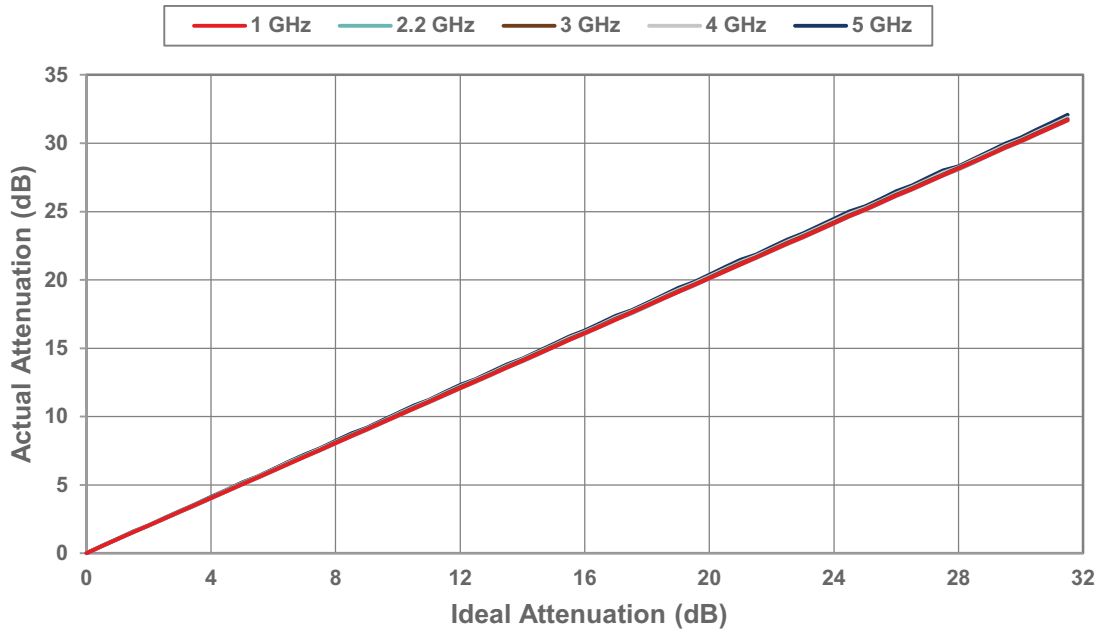

Figure 25 • 0.5 dB Major State Bit Error vs Attenuation Setting

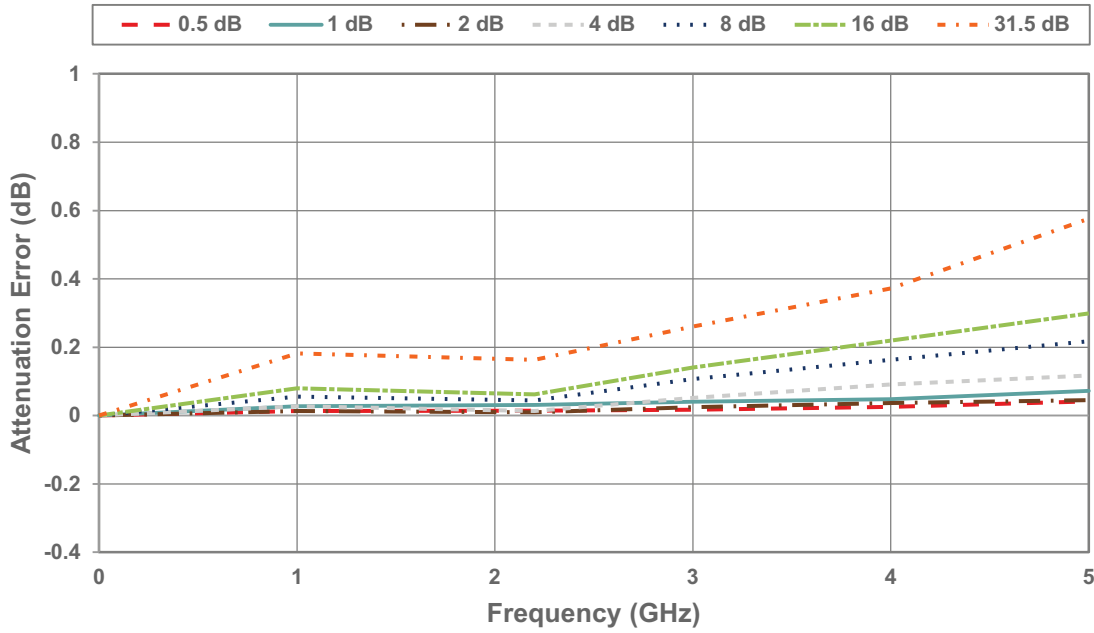

Figure 26 • 0.5 dB Attenuation Error vs Frequency

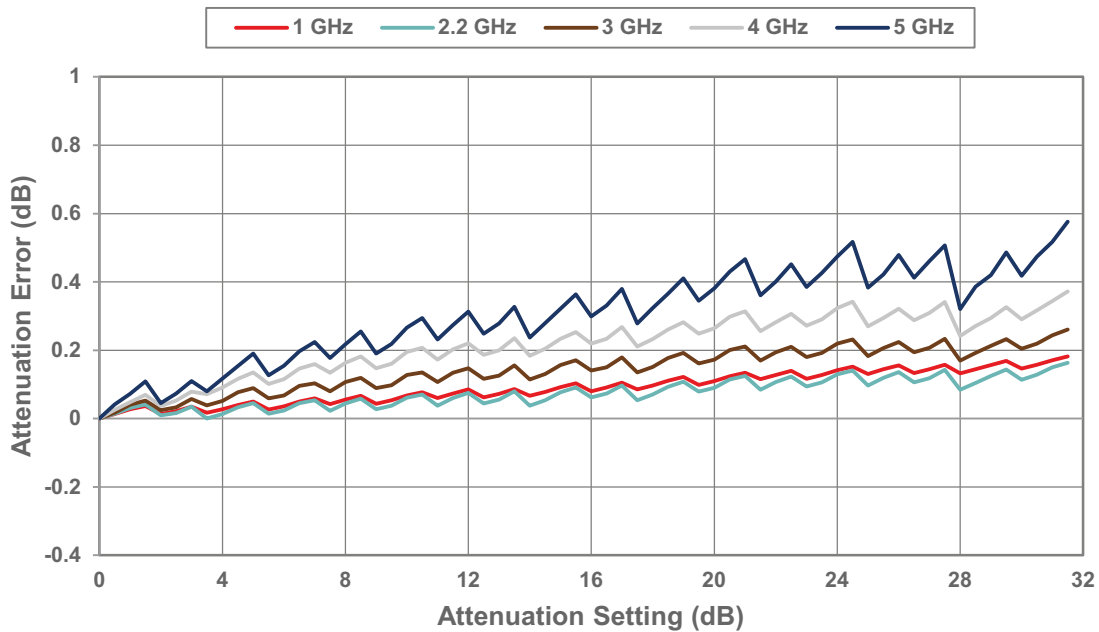
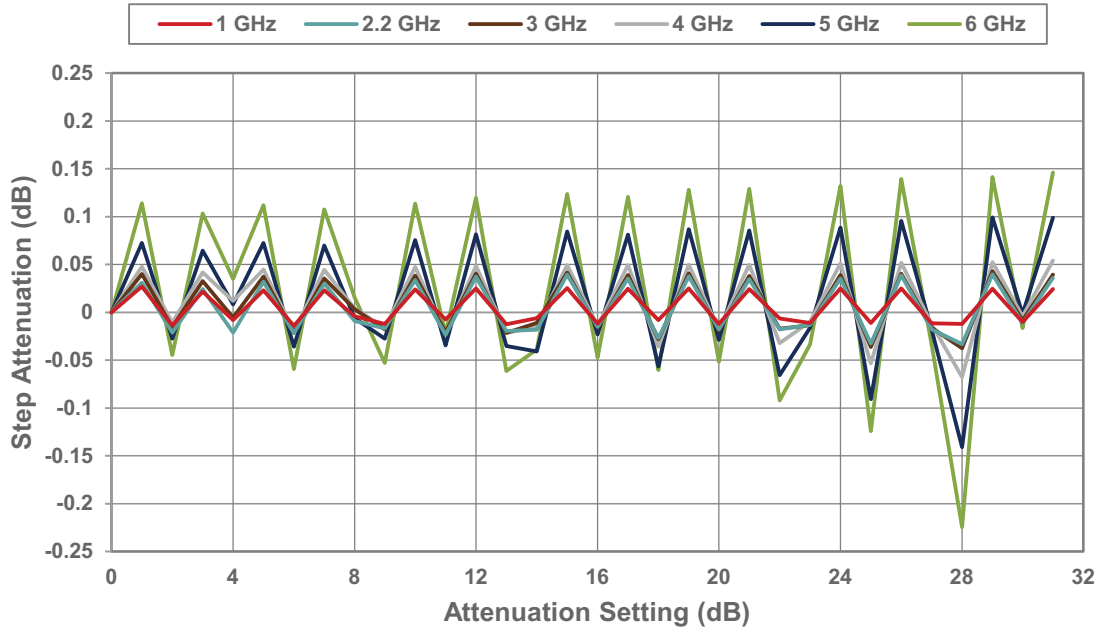

Figure 27 • 1 dB Step Attenuation vs Frequency^(*)



Note: * Monotonicity is held so long as step attenuation does not cross below -1 dB.

Figure 28 • 1 dB Step, Actual vs Frequency

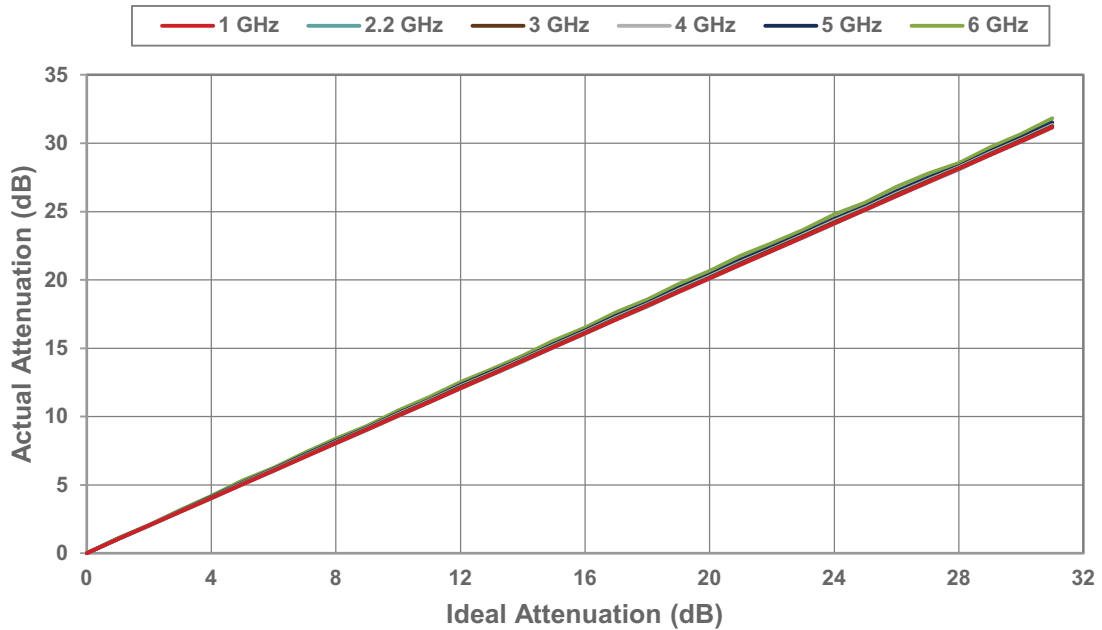

Figure 29 • 1 dB Major State Bit Error vs Attenuation Setting

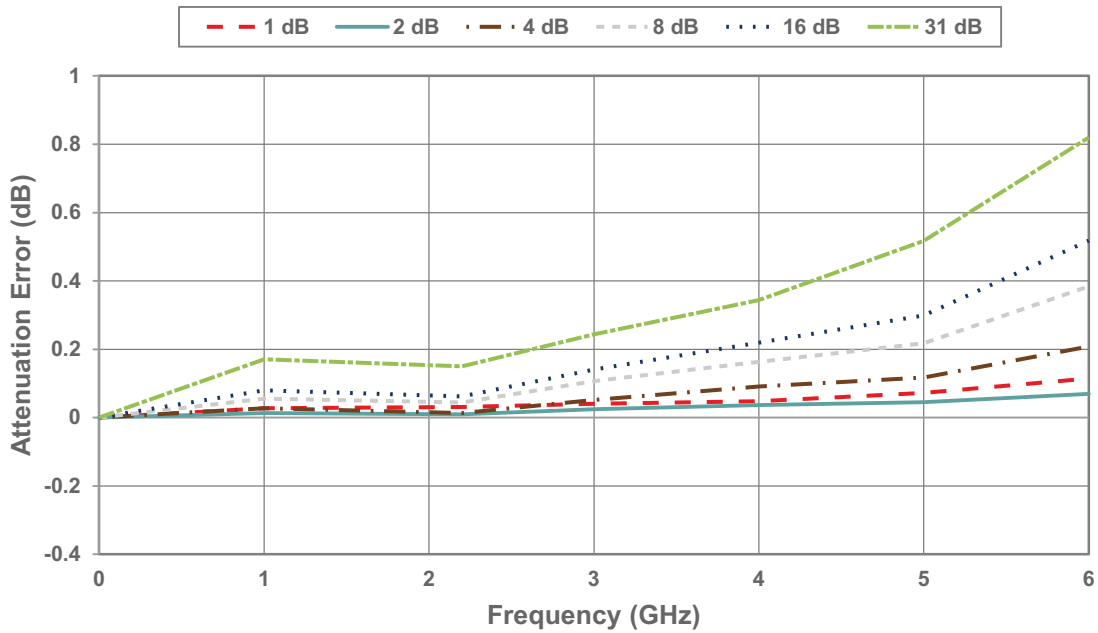

Figure 30 • 1 dB Attenuation Error vs Frequency

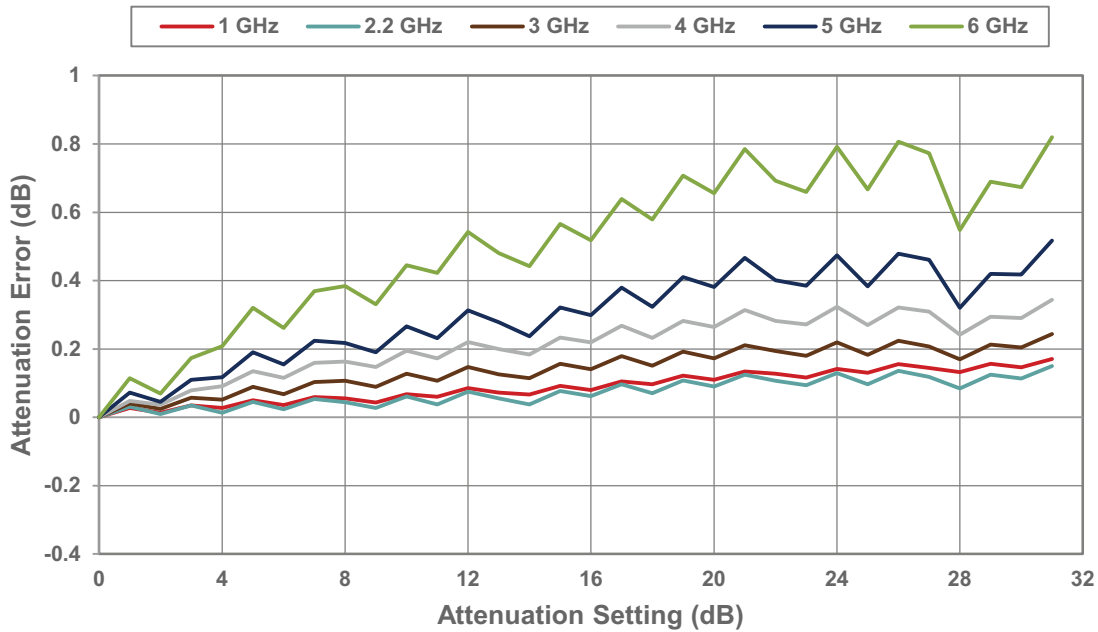

Figure 31 • Attenuation Transient (15.75–16 dB), Typical Switching Time = 275 ns

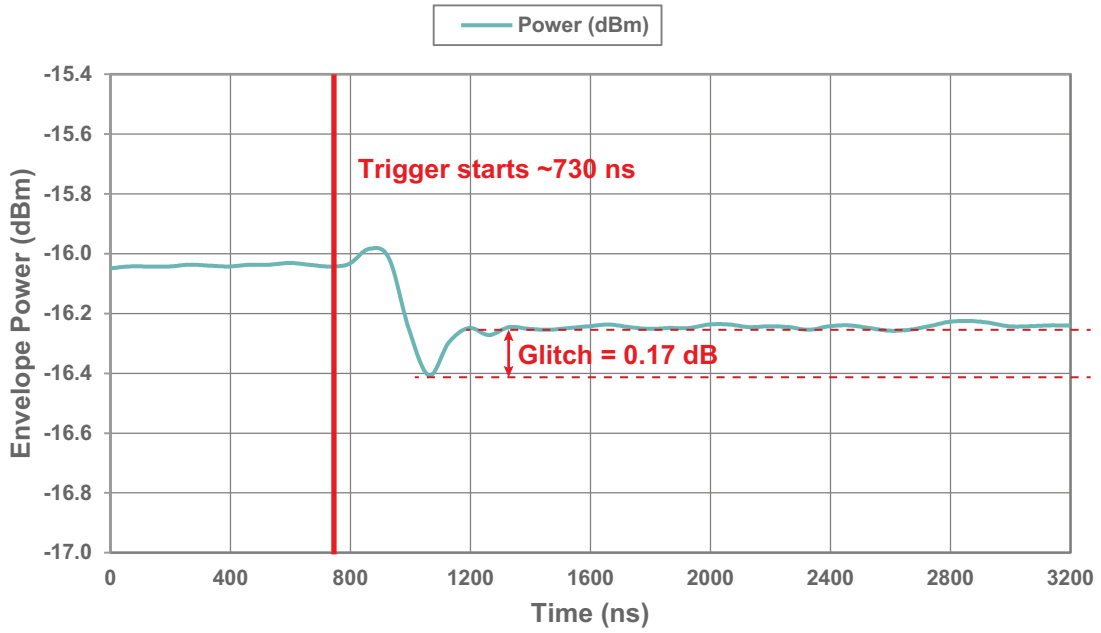
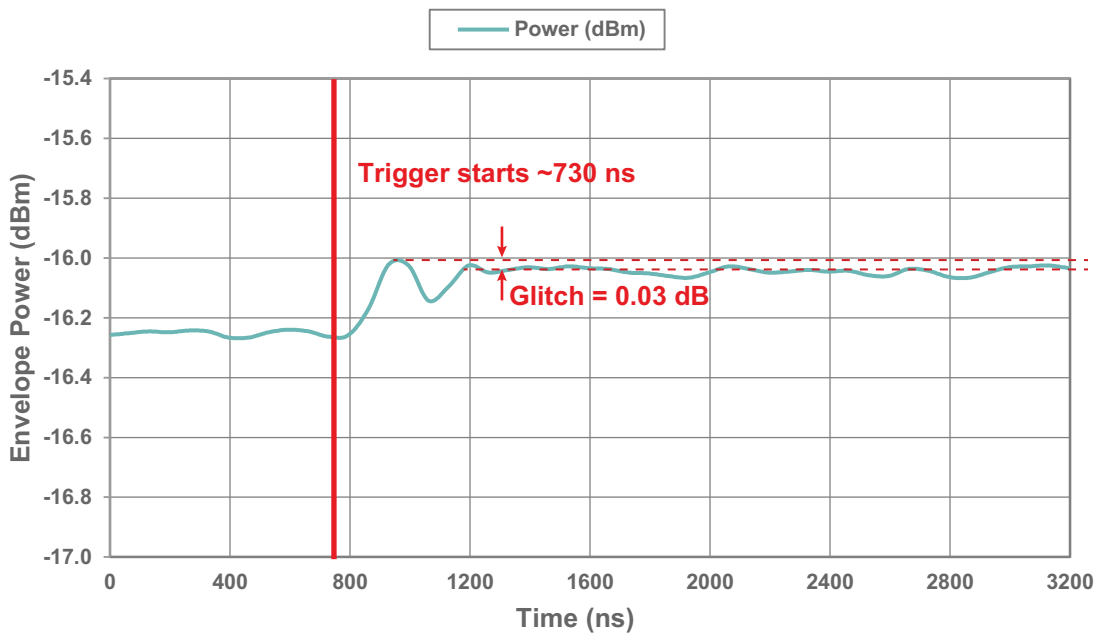

Figure 32 • Attenuation Transient (16–15.75 dB), Typical Switching Time = 275 ns



Evaluation Kit

The digital step attenuator evaluation board (EVB) was designed to ease customer evaluation of the PE43711 digital step attenuator. The PE43711 EVB supports Direct Parallel, Latched Parallel and Serial modes.

Evaluation Kit Setup

Connect the EVB with the USB dongle board and USB cable as shown in **Figure 33**.

Direct Parallel Programming Procedure

Direct Parallel programming is suitable for manual operation without software programming. For manual Direct Parallel programming, position the Parallel/Serial (P/S) select switch to the Parallel position. The LE switch must be switched to HIGH position. Switches D0–D6 are SP3T switches that enable the user to manually program the parallel bits. When D0–D6 are toggled to the HIGH position, logic high is presented to the parallel input. When toggled to the LOW position, logic low is presented to the parallel input. Setting LE and D0–D6 to the EXT position presents as OPEN, which is set for software programming of Latched Parallel and Serial modes. **Table 4** depicts the Parallel truth table.

Latched Parallel Programming Procedure

For automated Latched Parallel programming, connect the USB dongle board and cable that is provided with the evaluation kit (EVK) from the USB port of the PC to the J5 header of the PE43711 EVB, and set the LE and D0–D6 SP3T switches to the EXT position. Position the Parallel/Serial (P/S) select switch to the Parallel position. The evaluation software is written to operate the DSA in Parallel mode. Ensure that the software GUI is set to Latched Parallel mode. Use the software GUI to enable the desired attenuation state. The software GUI automatically programs the DSA each time an attenuation state is enabled.

Serial Programming Procedure

For automated Serial programming, connect the USB dongle board and cable that is provided with the EVK from the USB port of the PC to the J5 header of the PE43711 EVB, and set the LE and D0–D6 SP3T switches to the EXT position. Position the Parallel/Serial (P/S) select switch to the Serial position. The software GUI is written to operate the DSA in Serial mode. Use the software GUI to enable each setting to the desired attenuation state. The software GUI automatically programs the DSA each time an attenuation state is enabled.

Figure 33 • Evaluation Kit for PE43711

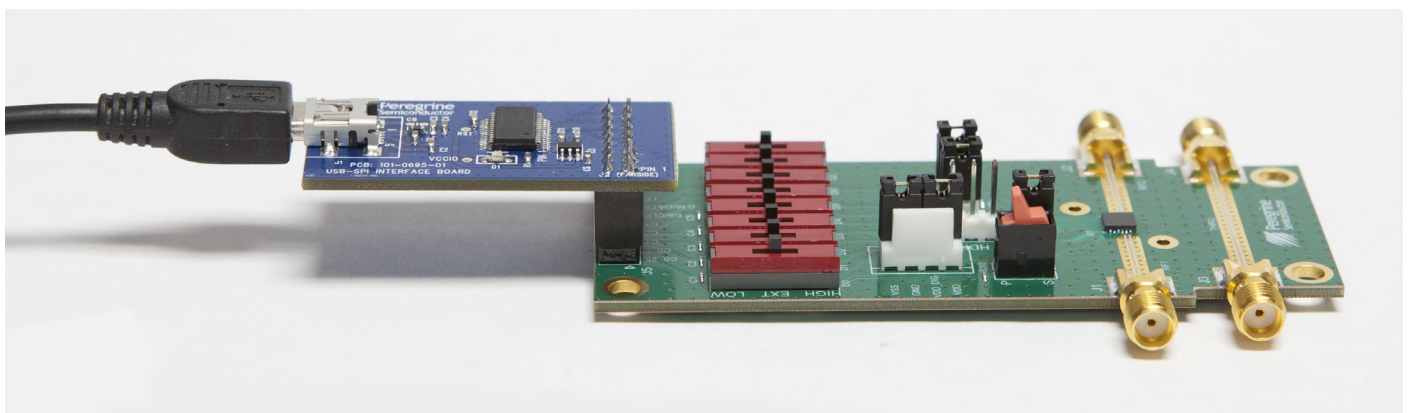
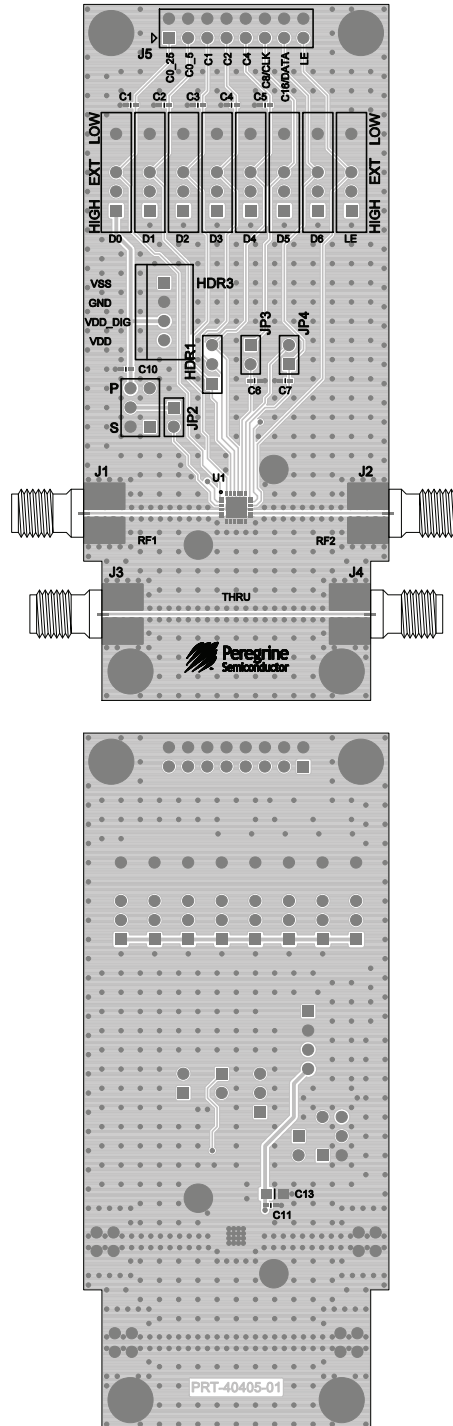

Figure 34 • Evaluation Kit Layout for PE43711



Pin Information

This section provides pinout information for the PE43711. **Figure 35** shows the pin map of this device for the available package. **Table 9** provides a description for each pin.

Figure 35 • Pin Configuration (Top View)

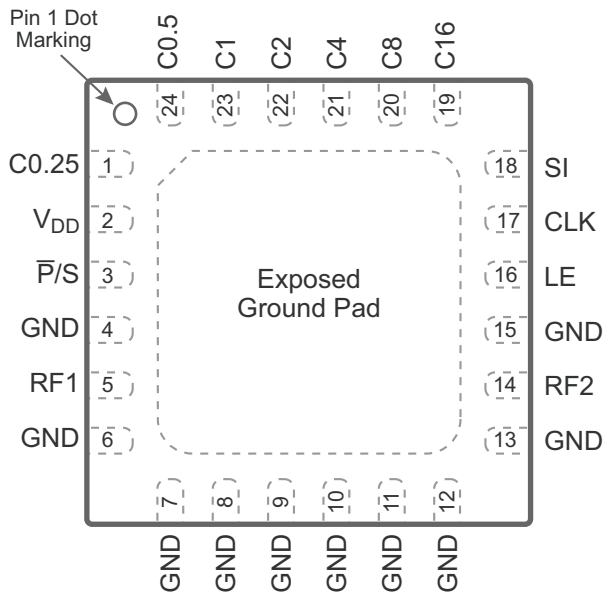

Table 9 • Pin Descriptions for PE43711

Pin No.	Pin Name	Description
1	C0.25 (D0) ⁽¹⁾	Attenuation control bit, 0.25 dB
2	V _{DD}	Supply voltage
3	\bar{P}/S	Serial/Parallel mode select
4, 6–13, 15	GND	Ground
5	RF1 ⁽²⁾	RF1 port (RF input)
14	RF2 ⁽²⁾	RF2 port (RF output)
16	LE	Serial interface Latch Enable input
17	CLK	Serial interface Clock input
18	SI	Serial interface Data input
19	C16 (D6) ⁽¹⁾	Parallel control bit, 16 dB
20	C8 (D5) ⁽¹⁾	Parallel control bit, 8 dB
21	C4 (D4) ⁽¹⁾	Parallel control bit, 4 dB
22	C2 (D3) ⁽¹⁾	Parallel control bit, 2 dB
23	C1 (D2) ⁽¹⁾	Parallel control bit, 1 dB
24	C0.5 (D1) ⁽¹⁾	Parallel control bit, 0.5 dB
Pad	GND	Exposed pad: ground for proper operation

Notes:

- 1) Ground C0.25, C0.5, C1, C2, C4, C8, and C16 if not in use.
- 2) RF pins 5 and 14 must be at 0 VDC. The RF pins do not require DC blocking capacitors for proper operation if the 0 VDC requirement is met.

Packaging Information

This section provides packaging data including the moisture sensitivity level, package drawing, package marking and tape-and-reel information.

Moisture Sensitivity Level

The moisture sensitivity level rating for the PE43711 in the 24-lead 4 × 4 mm QFN package is MSL1.

Package Drawing

Figure 36 • Package Mechanical Drawing for 24-lead 4 × 4 × 0.85 mm QFN

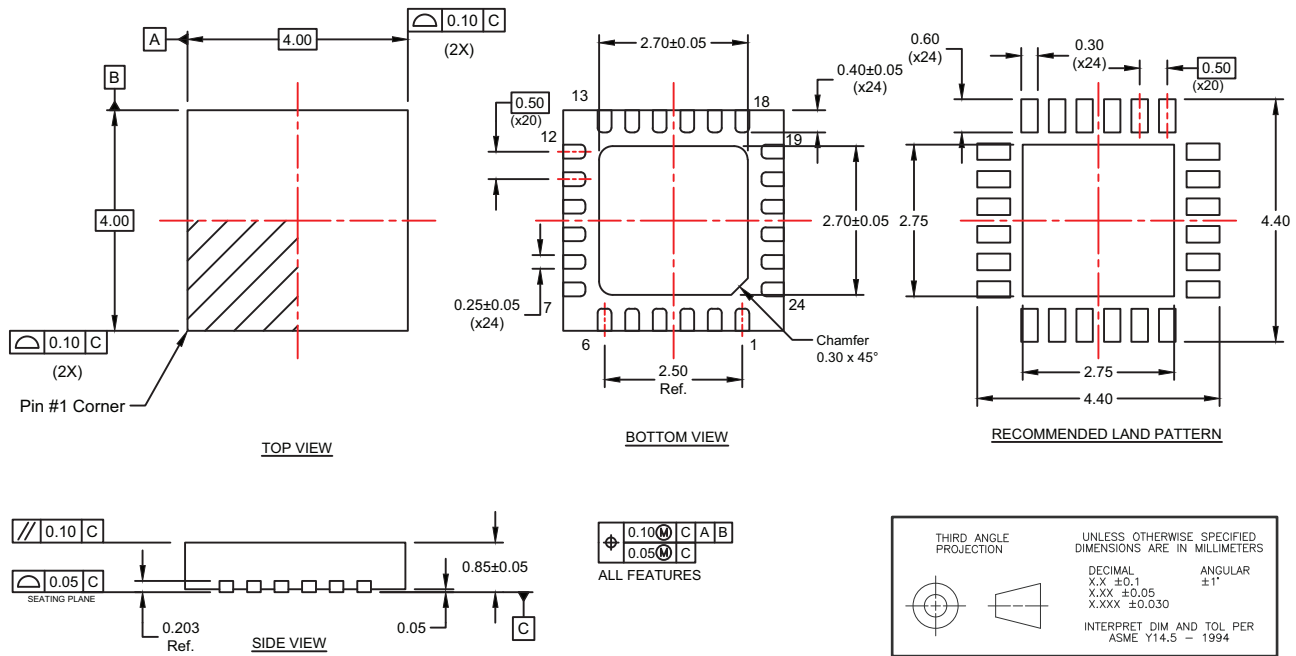

Top-Marking Specification

Figure 37 • Package Marking Specifications for PE43711

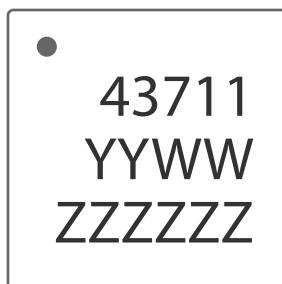

- = Pin 1 indicator
- YY = Last two digits of assembly year
- WW = Assembly work week
- ZZZZZZ = Assembly lot code (Maximum six characters)

Tape and Reel Specification

Figure 38 • Tape and Reel Specifications for 24-lead 4 × 4 × 0.85 mm QFN

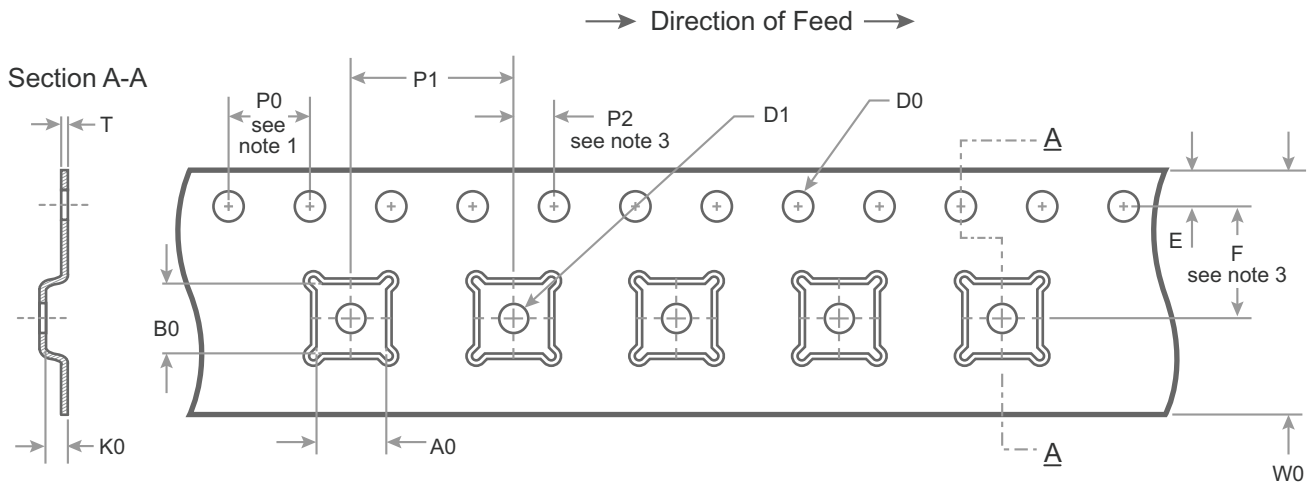

A0	4.35
B0	4.35
K0	1.10
D0	1.50 + 0.10/ -0.00
D1	1.50 min
E	1.75 ± 0.10
F	5.50 ± 0.05
P0	4.00
P1	8.00
P2	2.00 ± 0.05
T	0.30 ± 0.05
W0	12.00 ± 0.30

Notes:

1. 10 Sprocket hole pitch cumulative tolerance ±0.2
2. Camber in compliance with EIA 481
3. Pocket position relative to sprocket hole measured as true position of pocket, not pocket hole

Dimensions are in millimeters unless otherwise specified

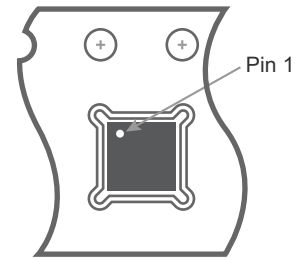

Device Orientation in Tape

Ordering Information

Table 10 lists the available ordering codes for the PE43711 as well as available shipping methods.

Table 10 • Order Codes for PE43711

Order Codes	Description	Packaging	Shipping Method
PE43711B-Z	PE43711 Digital step attenuator	Green 24-lead 4 × 4 mm QFN	3000 units / T&R
EK43711-03	PE43711 Evaluation kit	Evaluation kit	1 / Box

Document Categories

Advance Information

The product is in a formative or design stage. The datasheet contains design target specifications for product development. Specifications and features may change in any manner without notice.

Preliminary Specification

The datasheet contains preliminary data. Additional data may be added at a later date. Peregrine reserves the right to change specifications at any time without notice in order to supply the best possible product.

Product Specification

The datasheet contains final data. In the event Peregrine decides to change the specifications, Peregrine will notify customers of the intended changes by issuing a CNF (Customer Notification Form).

Product Brief

This document contains a shortened version of the datasheet. For the full datasheet, contact sales@psemi.com.

Sales Contact

For additional information, contact Sales at sales@psemi.com.

Disclaimers

The information in this document is believed to be reliable. However, pSemi assumes no liability for the use of this information. Use shall be entirely at the user's own risk. No patent rights or licenses to any circuits described in this document are implied or granted to any third party. pSemi's products are not designed or intended for use in devices or systems intended for surgical implant, or in other applications intended to support or sustain life, or in any application in which the failure of the pSemi product could create a situation in which personal injury or death might occur. pSemi assumes no liability for damages, including consequential or incidental damages, arising out of the use of its products in such applications.

Patent Statement

pSemi products are protected under one or more of the following U.S. patents: patents.psemi.com

Copyright and Trademark

©2017—2020, pSemi Corporation. All rights reserved. The Peregrine Semiconductor name, Peregrine Semiconductor logo and UltraCMOS are registered trademarks and the pSemi name, pSemi logo, HaRP and DuNE are trademarks of pSemi Corporation in the U.S. and other countries.

Mouser Electronics

Authorized Distributor

Click to View Pricing, Inventory, Delivery & Lifecycle Information:

[pSemi:](#)

[PE43711B-Z](#) [EK43711-03](#)