

IEC Appliance Inlet C8 with Filter, Front Side Mounting

Standard- or Medical-Filter



new



Snap-in mounting from front side

Screw-on mounting from front side

C8

 70° C

**Description**

- Panel Mount:
Screw-on or snap-in mounting from front side
- 2 Functions:
Appliance Inlet Protection class II, Line filter in standard and medical version
- Solder terminals or quick connect terminals

Approvals

- VDE Certificate Number: 40029278
- UL File Number: E72928

Characteristics

- Compact high performance filter
- Designed for standard and medical applications
- Qualified for use in equipment according IEC/EN 60950

Other versions on request

- Standard version without X-capacitor

References**Weblinks**

[pdf](#), [html](#), [General Product Information](#), [Approvals](#), [RoHS](#), [CHINA-RoHS](#), [Mating Connectors](#), [e-Store](#), [SCHURTER-Stock-Check](#), [Distributor-Stock-Check](#), [Accessories](#)

Technical Data

Ratings IEC	0.5 - 2.5A @ Ta 40 °C / 250VAC; 50Hz	Appliance-Inlet/-Outlet	C8 acc. to IEC/EN 60320-1
Ratings UL/CSA	0.5 - 6A @ Ta 40 °C / 250VAC; 60Hz	Line Filter	UL 498, CSA C22.2 no. 42 (for cold conditions) pin-temperature 70 °C, 2.5A, Protection Class 2
Dielectric Strength	> 1.7kVDC between L-N > 4kVDC between L/N-PE Test voltage (2 sec)	MTBF	Standard and Medical Version, IEC 60939, IEC 60601-1, UL 1283, UL 544, CSA C22.2 no. 8 Technical details
Impulse Withstand Voltage	> 2.5kV between L-N		> 6'700'000h acc. to MIL-HB-217 F
Allowable Operation Temp.	-25 °C to 85 °C		
Climatic Category	25/085/21 acc. to IEC 60068-1		
Degree of Protection	from front side IP 40 acc. to IEC 60529		
Protection Class	Suitable for appliances with protection class 2 acc. to IEC 61140		
Terminal	solder pin or quick connect terminals 6.3 x 0.8 or 4.8 x 0.8 mm		
Panel Thickness s	Screw Mounting screw torque max 0.5Nm Snap-in 1 mm to 3 mm		
Material: Housing	Thermoplastic, black, UL 94V-0		

Dimensions

Screw-on mounting from front side

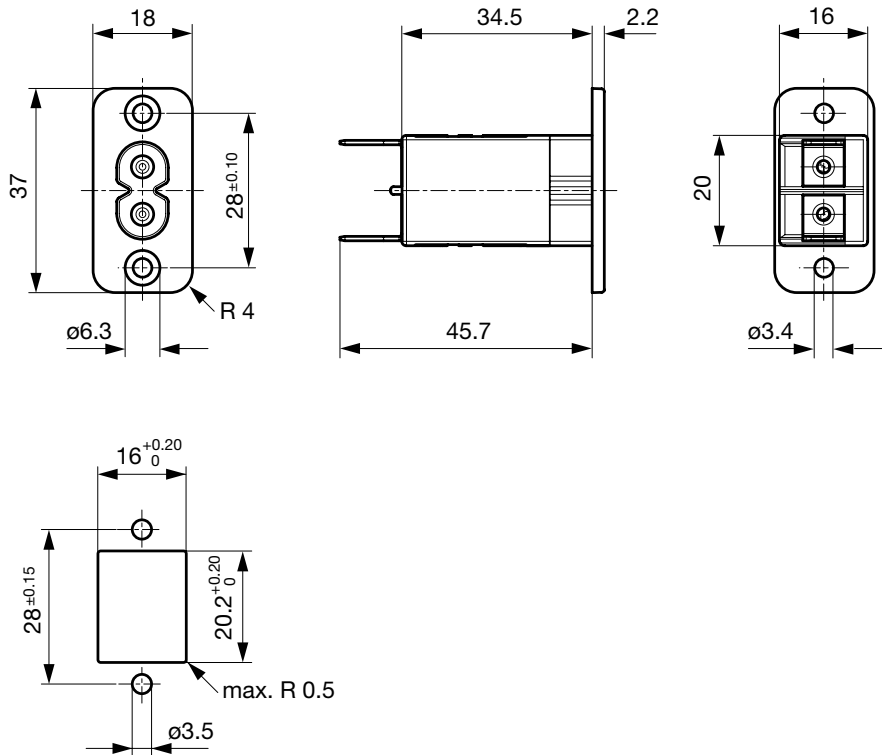

Snap-in mounting from front side

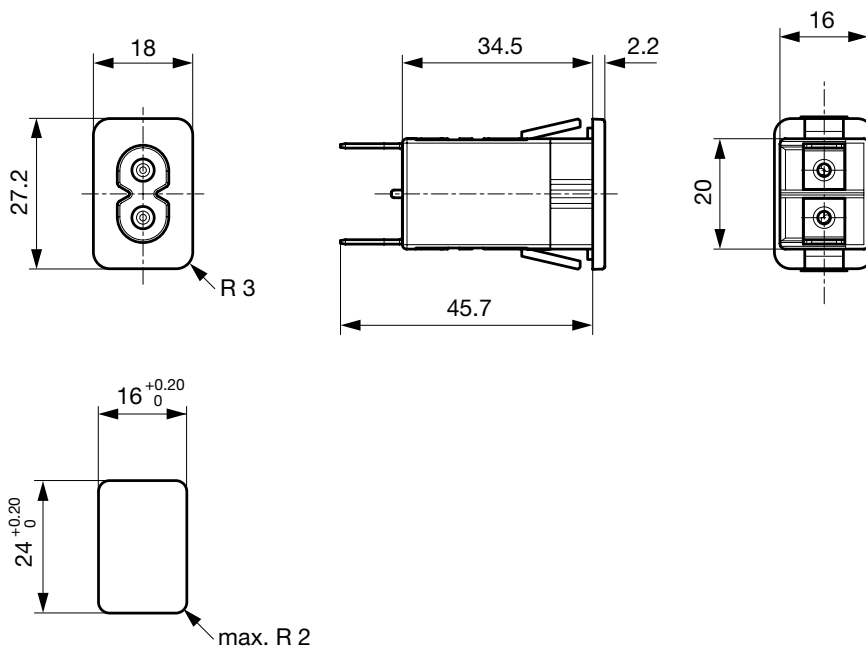

Technical Data of Filter-Components

Rated Current [A]	Filter-Type	Inductances L [mH]	Capacitance CX [nF]	Capacitance CY [nF]	R [MΩ]
0.5	Standard Version	2 x 18	100	-	-
1	Standard Version	2 x 8	100	-	-
2.5	Standard Version	2 x 1.2	100	-	-
4	Standard Version	2 x 0.8	100	-	-
6	Standard Version	2 x 0.3	100	-	-
0.5	Medical Version (M5)	2 x 18	100	-	1
1	Medical Version (M5)	2 x 8	100	-	1
2.5	Medical Version (M5)	2 x 1.2	100	-	1
4	Medical Version (M5)	2 x 0.8	100	-	1
6	Medical Version (M5)	2 x 0.3	100	-	1

Diagrams

Standard version

Medical version M5

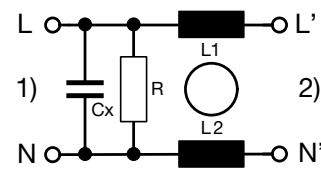
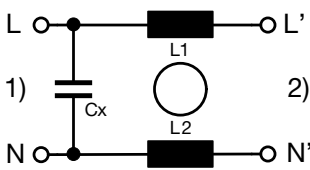

1) Line
2) Load

1) Line
2) Load

Derating Curves

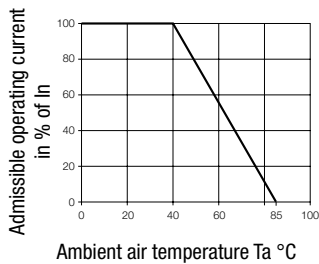

Attenuation Loss

--- differential mode ____ common mode

Standard version
0.5 A

1 A

2.5 A

4 A

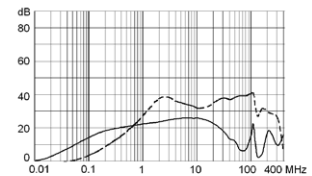
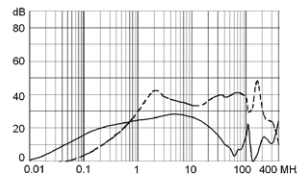
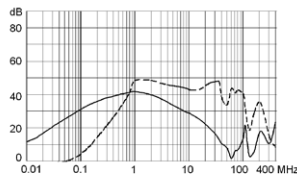
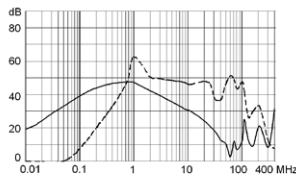

6 A

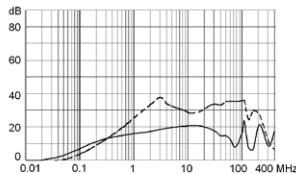

Medical version (M5)
0.5 A

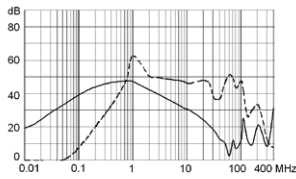

1 A

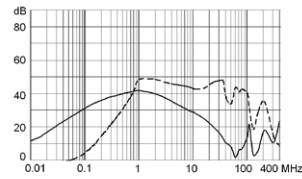

2.5 A

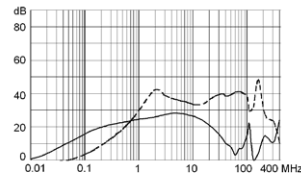

4 A

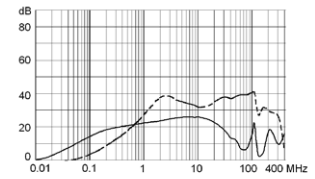

6 A

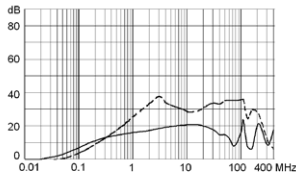

Variants

Rated Current [A]	Filter-Type	Mounting	Terminal	Order Number
0.5	Standard Version	Snap-in 1.0	Quick connect terminal 4.8 x 0.8 mm	5008.1010
0.5	Standard Version	Snap-in 1.5	Quick connect terminal 4.8 x 0.8 mm	5008.2010
1	Standard Version	Snap-in 1.5	Solder terminal	5008.2021
1	Standard Version	Snap-in 1.5	Quick connect terminal 6.3 x 0.8 mm	5008.2001
1	Standard Version	Snap-in 2.0	Quick connect terminal 4.8 x 0.8 mm	5008.3011
2.5	Standard Version	Snap-in 1.0	Quick connect terminal 4.8 x 0.8 mm	5008.1012
2.5	Standard Version	Snap-in 1.5	Solder terminal	5008.2022
2.5	Standard Version	Snap-in 1.5	Quick connect terminal 4.8 x 0.8 mm	5008.2012
2.5	Standard Version	Snap-in 2.0	Solder terminal	5008.3022
2.5	Standard Version	Snap-in 2.0	Quick connect terminal 6.3 x 0.8 mm	5008.3002
2.5	Standard Version	Screw	Solder terminal	5008.0022
2.5	Standard Version	Screw	Quick connect terminal 6.3 x 0.8 mm	5008.0002
2.5	Standard Version	Screw	Quick connect terminal 4.8 x 0.8 mm	5008.0012
4	Standard Version	Snap-in 1.5	Quick connect terminal 4.8 x 0.8 mm	5008.2014
6	Standard Version	Snap-in 1.0	Quick connect terminal 4.8 x 0.8 mm	5008.1016
6	Standard Version	Screw	Quick connect terminal 6.3 x 0.8 mm	5008.0006
0.5	Medical Version (M5)	Snap-in 1.0	Quick connect terminal 4.8 x 0.8 mm	5008.1110
1	Medical Version (M5)	Snap-in 1.0	Quick connect terminal 4.8 x 0.8 mm	5008.1111
1	Medical Version (M5)	Snap-in 2.0	Quick connect terminal 4.8 x 0.8 mm	5008.3111
1	Medical Version (M5)	Screw	Quick connect terminal 4.8 x 0.8 mm	5008.0111
2.5	Medical Version (M5)	Snap-in 1.0	Quick connect terminal 4.8 x 0.8 mm	5008.1112
2.5	Medical Version (M5)	Snap-in 2.0	Quick connect terminal 6.3 x 0.8 mm	5008.3102
4	Medical Version (M5)	Snap-in 1.0	Quick connect terminal 4.8 x 0.8 mm	5008.1114
6	Medical Version (M5)	Snap-in 1.0	Quick connect terminal 4.8 x 0.8 mm	5008.1116

Packaging unit

20 Pcs

Mating Outlets/Connectors

Category / Description



[Appliance Outlet Overview complete](#)

IEC Appliance Outlet D, Screw-on Mounting, Front or Rear Side, Solder Terminal	5082
--	------

[Appliance Outlet further types to 5008](#)



[Connector Overview complete](#)

IEC Appliance Outlet D, Inlay Mounting, Solder Terminal	5081
IEC Appliance Outlet D, Screw-on Mounting, Front Side, Solder Terminal	5084
IEC Appliance Outlet D, insert Mounting, Solder Terminal	5086

[Connector further types to 5008](#)



[Power Cord Overview complete](#)

Power Cord with IEC Connector C7, Straight 70°C	2510
Power Cord with IEC Connector C7, Angled	2511
Power Cord with IEC Plug C7, Angled	2514
Power Cord with IEC Connector C7, Straight 70°C	4810

[Power Cord further types to 5008](#)