

Features

- High 6.4kVDC/1s isolation
- Wide operating temperature range from -40°C to +90°C without derating
- High capacitive load capability
- Continuous short circuit protection
- Efficiency up to 80%

Unregulated Converters

Description

The RK/H6 and RH/H6 series 1W DC/DC converters feature high 6.4kVDC isolation and an extended operating temperature range up to +90°C without derating, yet are lower cost than standard high isolation converters. They are suitable for demanding industrial and high isolation test and measurement applications.

Selection Guide

Part Number	nom. Input Voltage Range [VDC]	Output Voltage [VDC]	Output Current [mA]	Efficiency typ. [%]	Max. Capacitive Load ⁽¹⁾ [μF]
RK-xx3.3S/H6	5, 12, 15, 24	3.3	303	71-74	1000
RK-xx05S/H6	5, 12, 15, 24	5	200	74-77	1000
RK-xx12S/H6	5, 12, 15, 24	12	84	77-79	220
RK-xx15S/H6	5, 12, 15, 24	15	66	77-80	220
RH-xx3.3D/H6	5, 12, 15, 24	±3.3	±152	73-74	±330
RH-xx05D/H6	5, 12, 15, 24	±5	±100	74-77	±330
RH-xx12D/H6	5, 12, 15, 24	±12	±42	77-80	±100
RH-xx15D/H6	5, 12, 15, 24	±15	±33	78-80	±100

Notes:

Note1: Max. capacitive load is tested at nominal input voltage and full load

Model Numbering

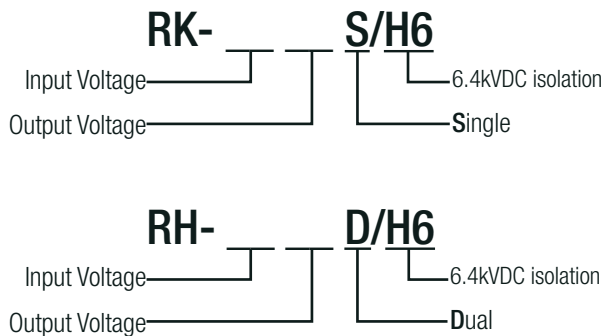

Notes:

Note2: add suffix „K“ for Single output or suffix „H“ for Dual output

Ordering Examples:

RK-123.3S/H6 = 12VDC Input Voltage, 3.3VDC Output Voltage, Single Output, 6.4kVDC/1s isolation
 RH-0505D/H6 = 5VDC Input Voltage, 5VDC Output Voltage, Dual Output, 6.4kVDC/1s isolation



RK/H6 & RH/H6

1 Watt
 SIP7
 Single and Dual Output



UL60950-1 certified
 CAN/CSA C22.2 No. 60950-1-07 certified
 UL62368-1 certified
 CAN/CSA C22.2 No. 62368-1-14 certified
 IEC/EN60950-1 certified
 IEC/EN62368-1 certified
 CB report

Specifications (measured @ Ta= 25°C, nom. Vin, full load and after warm-up unless otherwise stated)

BASIC CHARACTERISTICS

Parameter	Condition	Min.	Typ.	Max.
Internal Input Filter				capacitor
Input Voltage Range			±10%	
Start-up Time			20ms	
Internal Operating Frequency			80kHz	
Minimum Load			0%	
Output Ripple and Noise	20MHz BW		60mVp-p	120mVp-p

Efficiency vs. Load

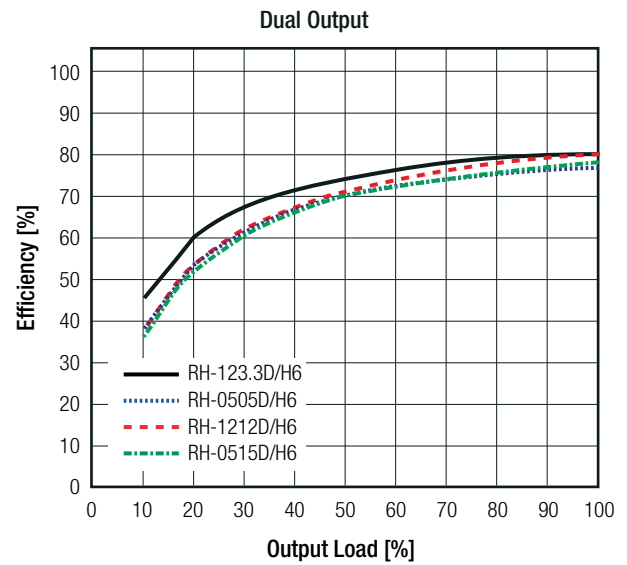
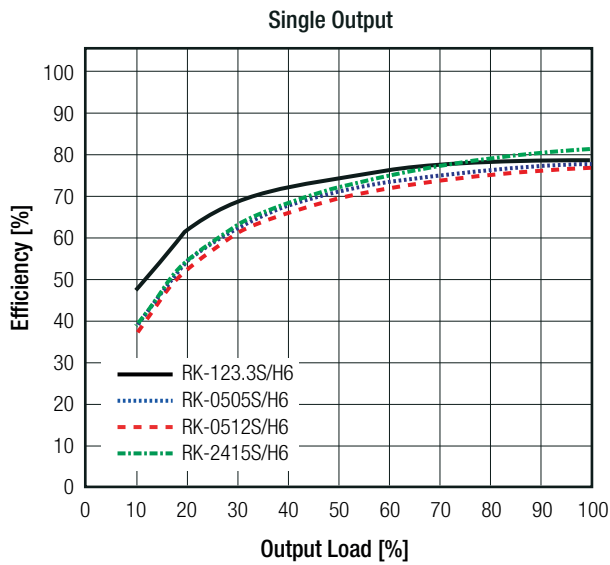

REGULATIONS

Parameter	Condition	Values
Output Accuracy		±5.0% max.
Line Regulation	low line to high line, max. load	±1.2% of 1.0% Vin typ.
Load Regulation ⁽³⁾	10% to 100% load	10% max.

Notes:

Note3: Operation below 10% load will not harm the converter, but specifications may not be met

Deviation vs. Load

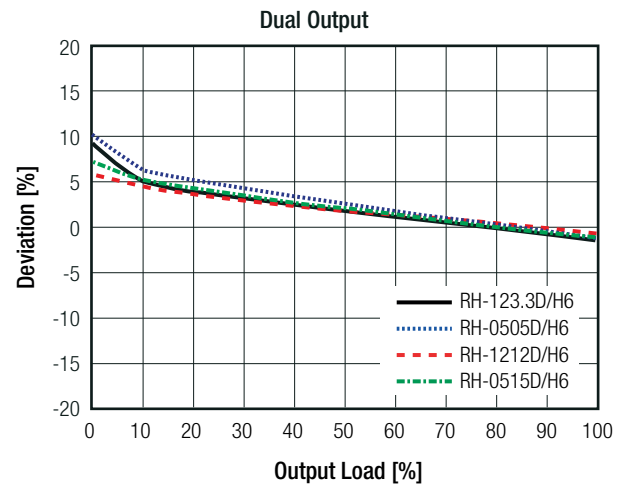
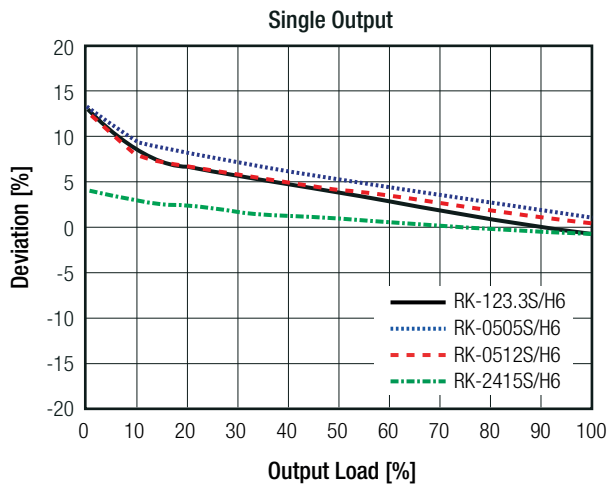

Specifications (measured @ Ta= 25°C, nom. Vin, full load and after warm-up unless otherwise stated)

PROTECTIONS			
Parameter	Condition		Value
Short Circuit Protection (SCP)			continuous
Isolation Voltage ⁽⁴⁾	I/P to O/P	tested for 1 second rated for 1 minute	6.4kVDC 5.2kVDC
Isolation Resistance			10GΩ min.
Isolation Capacitance			75pF max.
Insulation Grade			functional
Notes:			
Note4: For repeat Hi-Pot testing, reduce the time and/or the test voltage			
Note5: Refer to local safety regulations if input over-current protection is also required. Recommended fuse: slow blow type			

ENVIRONMENTAL			
Parameter	Condition		Value
Operating Temperature Range	without derating @ free air convection (see graph)		-40°C to +90°C
Operating Altitude			5000m
Operating Humidity	non-condensing		5% - 95% RH max.
MTBF	according to MIL-HDBK-217F; G.B.	+25°C +85°C	14919 x 10 ³ hours 9468 x 10 ³ hours

Derating Graph

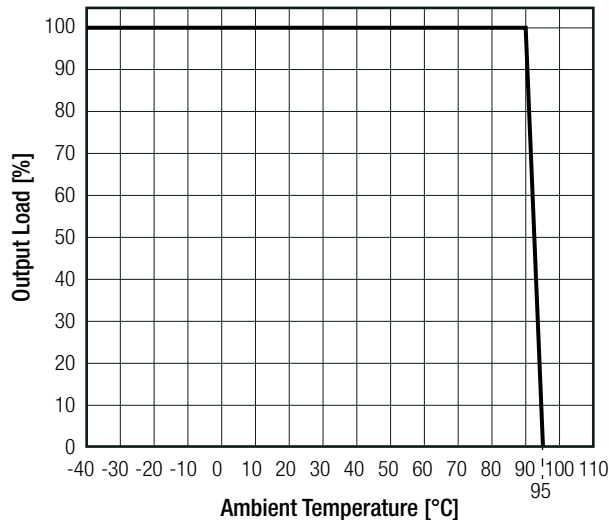

SAFETY AND CERTIFICATIONS		
Certificate Type	Report / File Number	Standard
Information Technology Equipment - General Requirements for Safety	E224736-A25-UL	UL60950-1, 2nd Edition, 2014 CAN/CSA-C22.2 No. 60950-1-07, 2nd Edition, 2014
Audio/Video, information and communication technology equipment - Part1: Safety requirements		UL62368-1, 2nd Edition, 2014 CAN/CSA-C22.2 No. 62368-1-14, 2nd Edition, 2014
Information Technology Equipment, General Requirements for Safety (CB)	E224736-A26-CB-1	IEC60950-1:2005, 2nd Edition + A2:2013
Information Technology Equipment, General Requirements for Safety		EN60950-1:2006 + A2:2013
Audio/video, information and communication technology equipment Part 1: safety requirements (CB)	OFF-4787079973-A-2	IEC62368-1:2014, 2nd Edition
Audio/video, information and communication technology equipment Part 1: safety requirements		EN62368-1:2014
continued on next page		

Specifications (measured @ Ta= 25°C, nom. Vin, full load and after warm-up unless otherwise stated)

Certificate Type	Report / File Number	Standard
EAC	RU-AT.49.09571	TP TC 004/2011
RoHS 2		RoHS-2011/65/EU + AM-2015/863

EMI Compliance	Condition	Standard / Criterion
Electromagnetic compatibility of multimedia equipment - Emission requirements	with external filter (see filter suggestion below)	EN55032, Class B EN55032, Class A

EMC Filter Suggestion according to EN55032

Single Output

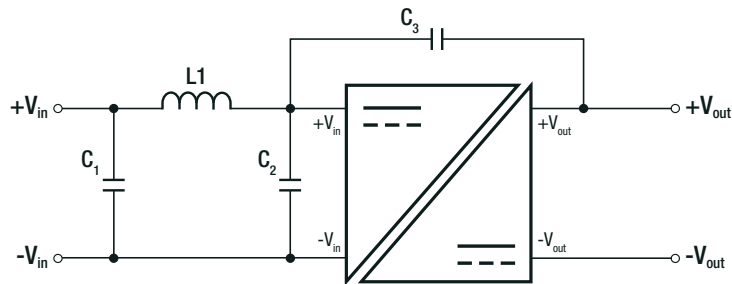

Component List Class A

MODEL	C1	L1	C2	C3
RK-0505S/H6	10µF 100V MLCC	12µH choke RLS-126	N/A	N/A
RK-0515S/H6				
RK-2405S/H6				

Component List Class B

MODEL	C1	L1	C2	C3
RK-0505S/H6	10µF 100V MLCC	12µH choke RLS-126	4.7µF 50V MLCC	N/A
RK-0515S/H6				2.2nF
RK-2405S/H6				

Dual Output

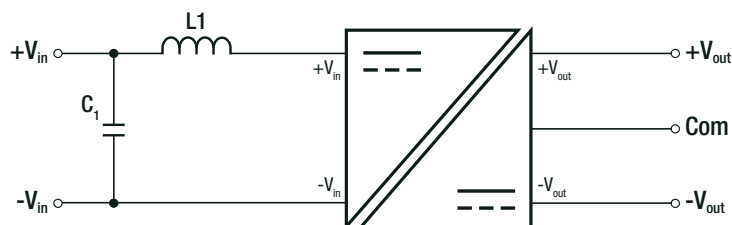

Component List Class A

MODEL	C1	L1
RH-0505D/H6	1µF 100V MLCC	68µH choke RLS-686
RH-1205D/H6		
RH-1212D/H6		
RH-2405D/H6		

Component List Class B

MODEL	C1	L1
RH-0505D/H6	4.7µF 50V MLCC	68µH choke RLS-686
RH-1205D/H6		
RH-1212D/H6		
RH-2405D/H6		

Notes:

Note6: Filter suggestions are valid for indicated part numbers only. For other part numbers, please contact RECOM tech support for advice

DIMENSION and PHYSICAL CHARACTERISTICS

Parameter	Type	Value
Material	case potting	non-conductive black plastic, (UL94 V-0) epoxy, (UL94 V-0)
Dimension (LxWxH)		19.65 x 7.05 x 10.2mm
Weight		2.7g typ.

continued on next page

Specifications (measured @ Ta= 25°C, nom. Vin, full load and after warm-up unless otherwise stated)

Dimension Drawing (mm)

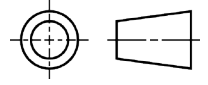
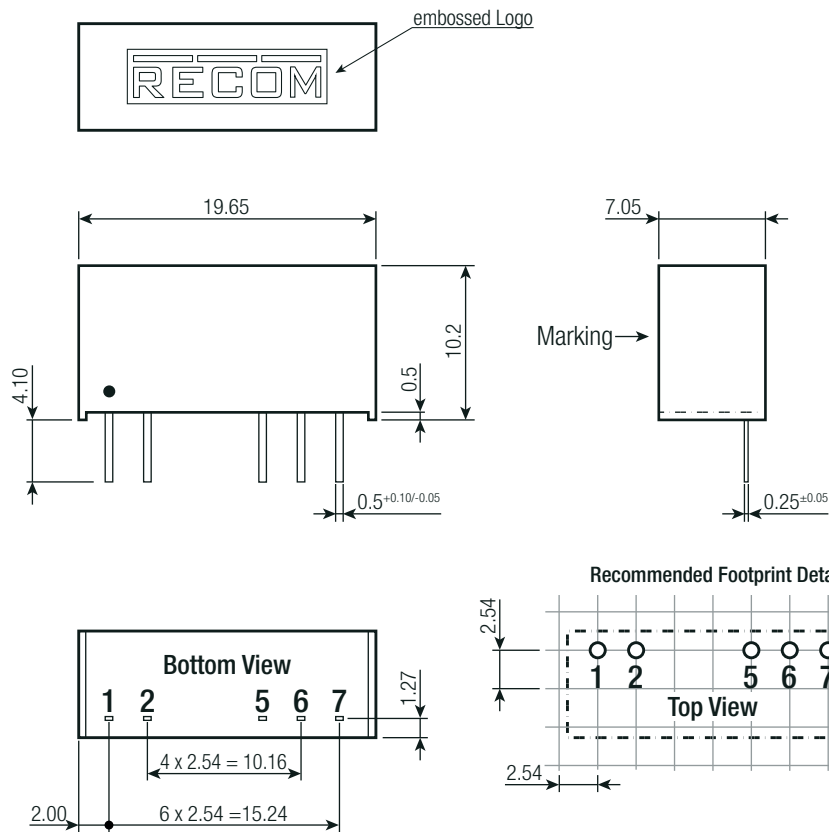

Pinning information

Pin #	Single	Dual
1	+Vin	+Vin
2	-Vin	-Vin
5	-Vout	-Vout
6	no pin	Com
7	+Vout	+Vout

Tolerance:
xx.x= ±0.5mm
xx.xx= ±0.25mm

PACKAGING INFORMATION

Parameter	Type	Value
Packaging Dimension (LxWxH)	tube	520.0 x 16.5 x 9.0mm
Packaging Quantity	tube	25pcs
Storage Temperature Range		-55°C to +125°C
Storage Humidity	non-condensing	95% RH max.

The product information and specifications may be subject to changes even without prior written notice. The product has been designed for various applications; its suitability lies in the responsibility of each customer. The products are not authorized for use in safety-critical applications without RECOM's explicit written consent. A safety-critical application is an application where a failure may reasonably be expected to endanger or cause loss of life, inflict bodily harm or damage property. The applicant shall indemnify and hold harmless RECOM, its affiliated companies and its representatives against any damage claims in connection with the unauthorized use of RECOM products in such safety-critical applications.

Mouser Electronics

Authorized Distributor

Click to View Pricing, Inventory, Delivery & Lifecycle Information:

RECOM:

[RK-053.3S/H6](#) [RK-123.3S/H6](#) [RK-153.3S/H6](#) [RK-243.3S/H6](#) [RK-0505S/H6](#) [RK-1205S/H6](#) [RK-1505S/H6](#) [RK-2405S/H6](#) [RK-0512S/H6](#) [RK-1212S/H6](#) [RK-1512S/H6](#) [RK-2412S/H6](#) [RK-0515S/H6](#) [RK-1215S/H6](#) [RK-1515S/H6](#) [RK-2415S/H6](#) [RH-053.3D/H6](#) [RH-123.3D/H6](#) [RH-153.3D/H6](#) [RH-243.3D/H6](#) [RH-0505D/H6](#) [RH-1205D/H6](#) [RH-1505D/H6](#) [RH-2405D/H6](#) [RH-0512D/H6](#) [RH-1212D/H6](#) [RH-1512D/H6](#) [RH-2412D/H6](#) [RH-0515D/H6](#) [RH-1215D/H6](#) [RH-1515D/H6](#) [RH-2415D/H6](#)