

L452











Data Logger

Thank you for purchasing an **L452 Data Logger**.

For best results from your instrument:

- **read** these operating instructions carefully,
- **comply** with the precautions for use.

	WARNING, risk of DANGER! The operator must refer to these instructions whenever this danger symbol appears.
	Information or useful tip.
	Magnet.
	Earth.
	The product is declared recyclable following an analysis of the life cycle in accordance with standard ISO 14040.
	Chauvin Arnoux has adopted an Eco-Design approach in order to design this appliance. Analysis of the complete life-cycle has enabled us to control and optimize the effects of the product on the environment. In particular this appliance exceeds regulation requirements with respect to recycling and reuse.
	
	The CE marking indicates conformity with European directives, in particular LVD and EMC.
	The rubbish bin with a line through it indicates that, in the European Union, the product must undergo selective disposal in compliance with Directive WEEE 2012/19/EU. This equipment must not be treated as household waste.

PRECAUTIONS FOR USE

This instrument is compliant with safety standard IEC 61010-2-30, and the leads are compliant with IEC 61010-031, for voltages of 30V with respect to earth. Failure to observe the safety instructions may result in electric shock, fire, explosion, and destruction of the instrument and of the installations.

- The operator and/or the responsible authority must carefully read and clearly understand the various precautions to be taken in use. Sound knowledge and a keen awareness of electrical hazards are essential when using this instrument.
- Do not use the instrument on networks of which the voltage exceeds those mentioned.
- Never exceed the protection limits stated in the specifications.
- Observe the conditions of use, namely the temperature, the relative humidity, the altitude, the degree of pollution, and the place of use.
- Do not use the instrument if it seems to be damaged, incomplete, or poorly closed.
- Before each use, check the condition of the insulation on the leads, housing, and accessories. Any item of which the insulation is deteriorated (even partially) must be set aside for repair or scrapping.
- Do not use this instrument in an explosive atmosphere or in the presence of flammable gases or vapours.
- Before using your instrument, check that it is perfectly dry. If it is wet, it must be thoroughly dried before it can be connected or used.
- Use only cables and accessories consistent with the specifications of the instrument.
- Use personal protection equipment systematically.
- All troubleshooting and metrological checks must be done by competent, accredited personnel.

CONTENTS

1. FIRST USE	4
1.1. Delivery condition	4
1.2. Accessories	4
1.3. Spare parts	5
1.4. Battery charging	5
2. PRESENTATION OF THE INSTRUMENT	6
2.1. Functions of the instrument	6
2.2. Side view	6
2.3. On the back	7
2.4. Display unit	7
3. SETTINGS OF THE INSTRUMENT	8
3.1. Organization of the screens.....	8
3.2. Choosing a language.....	8
3.3. Setting the time and date.....	9
3.4. Configuring the Bluetooth link.....	10
3.5. Restoring the original configuration.....	11
3.6. Display of product information.....	11
3.7. Switching the instrument off	12
4. USE	13
4.1. Changing a parameter.....	13
4.2. Configuring the measurement channels.....	13
4.3. Connecting probes, sensors, transmitters, or signal conditioners	15
4.4. Display of the measurements	15
4.5. Recording data	17
4.6. Clearing memory	19
5. DATA LOGGER TRANSFER SOFTWARE	20
5.1. Functions	20
5.2. Installation	20
5.3. USB connection	20
5.4. Bluetooth communication	21
5.5. Remote mode	22
6. TECHNICAL CHARACTERISTICS	23
6.1. Reference conditions.....	23
6.2. Electrical characteristics	23
6.3. Power supply	23
6.4. Memory.....	24
6.5. Bluetooth	24
6.6. USB	24
6.7. Environmental conditions	24
6.8. Mechanical characteristics	25
6.9. Compliance with international standards.....	25
6.10. Electromagnetic compatibility (CEM).....	25
7. MAINTENANCE	26
7.1. Cleaning	26
7.2. Replacing the batteries.....	26
7.3. Updating the embedded software.....	26
8. WARRANTY	27

1. FIRST USE

1.1. DELIVERY CONDITION

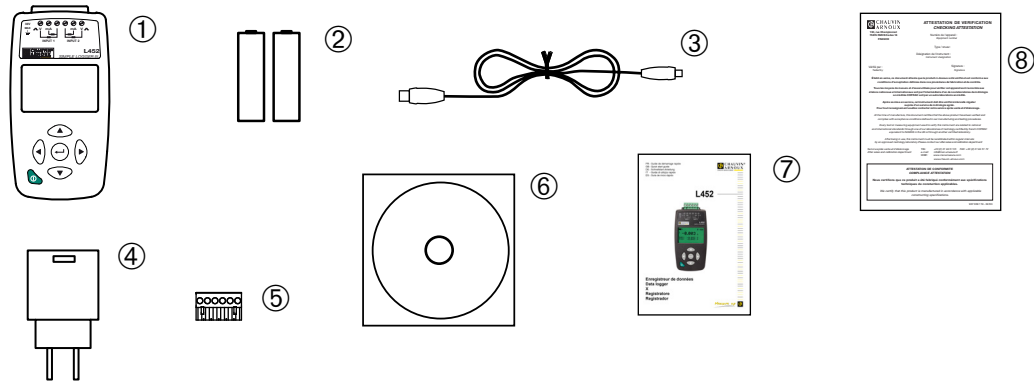

Figure 1

- ① One L452 Data Logger.
- ② Two 1.2V, 2400mA NiMH batteries.
- ③ One USB A / micro USB cord 1.80m long.
- ④ One USB mains adapter.
- ⑤ One connecting strip with 6 screw terminals.
- ⑥ One CD containing the user manual (1 file per language) and Data Logger Transfer software.
- ⑦ One multilingual getting started guide.
- ⑧ One certificate of verification.

1.2. ACCESSORIES

One wall mount

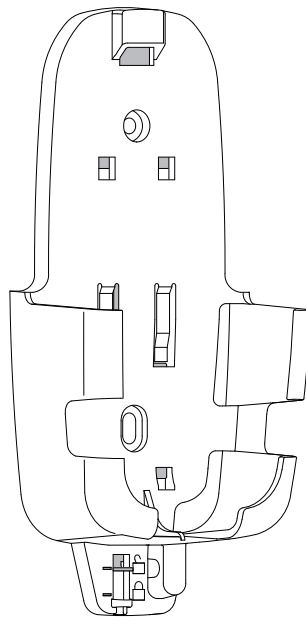

Figure 2

This is attached to the wall, and makes it possible to protect the instrument against theft by padlocking it.

1.3. SPARE PARTS

One USB mains adapter and one USB A / micro USB cord 1.80m long.
One set of 5 connecting strips with 6 screw terminals.
One set of two 1.2V, 2400mA NiMH batteries.

For accessories and spares, visit our web site:
www.chauvin-arnoux.com

1.4. BATTERY CHARGING

- Turn the instrument over.
- Remove the battery compartment cover by pushing it as far as the marks in the direction indicated by the arrows, then lifting it off.
- Insert the 2 batteries provided, paying attention to the polarity.

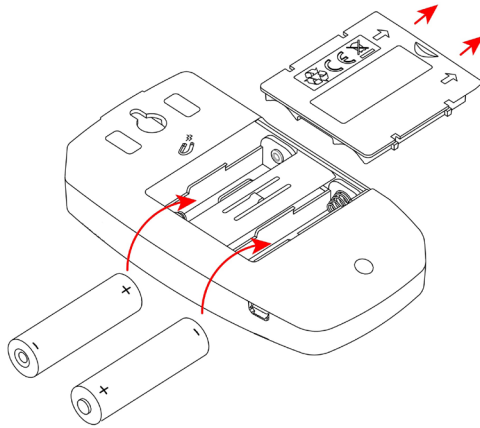

Figure 3

- Put the battery compartment cover back on and push it closed.
- Connect the micro USB cord to the instrument, then the USB part to the mains adapter.

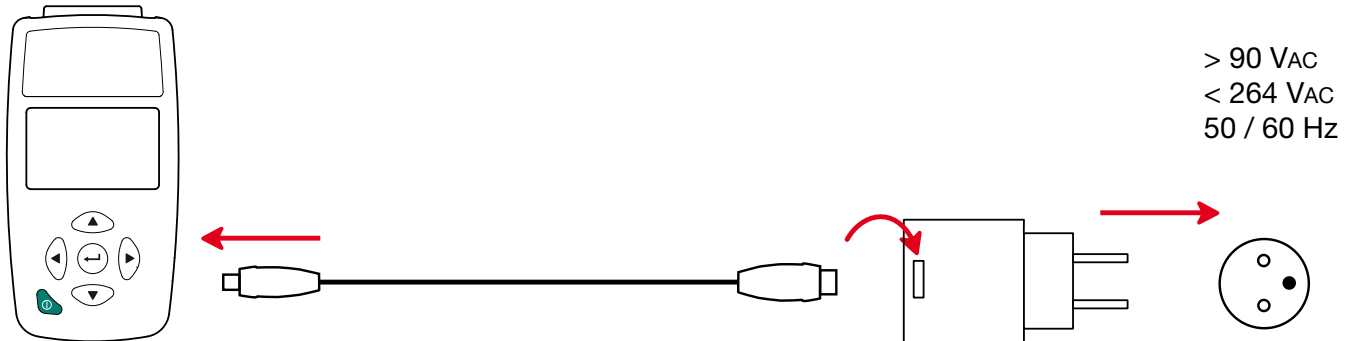

Figure 4

- If the batteries are fully discharged, charging takes approximately 5 hours.

2. PRESENTATION OF THE INSTRUMENT

2.1. FUNCTIONS OF THE INSTRUMENT

The L452 Data Logger is a two-channel recorder. It can be powered either by the rechargeable batteries or by mains, via a USB cable. It can record up to 16 million measurements in up to 1024 sessions.

It is used:

- to record DC voltages up to 10V,
- to record direct currents from 4 to 20mA,
- to count pulses,
- to detect events on its discrete inputs.

The voltage and current measurements can be sampled at intervals from 200ms to 1 minute. The sampled quantities can be averaged (means) over periods from 200ms to 1 hour and recorded in the internal memory.

The L452 Data Logger is used to check and measure process applications, water, gas, and power meters, or to monitor the environment. It can operate in the local mode or in the remote mode. It can communicate by USB or by Bluetooth.

2.2. SIDE VIEW

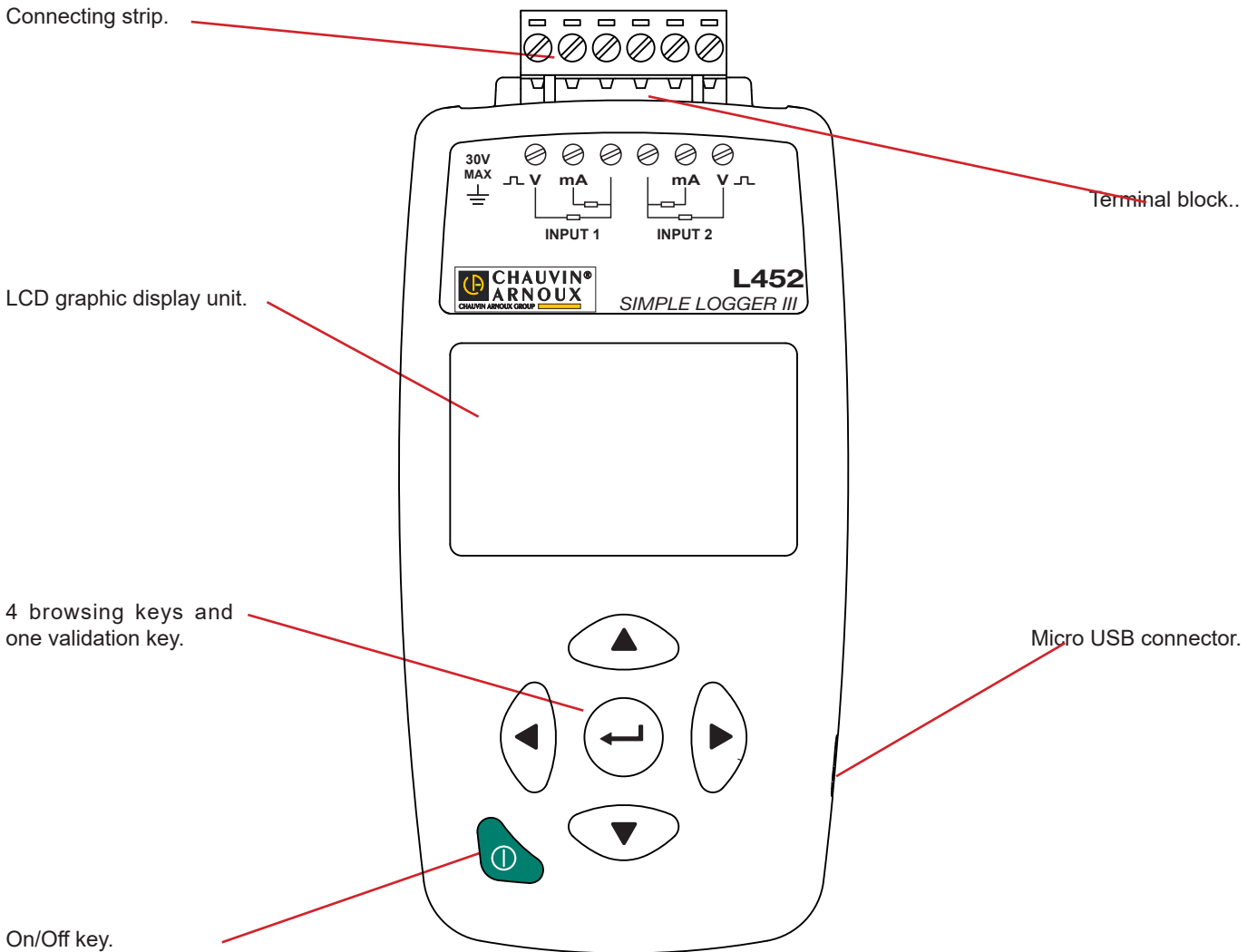

Figure 5

2.3. ON THE BACK

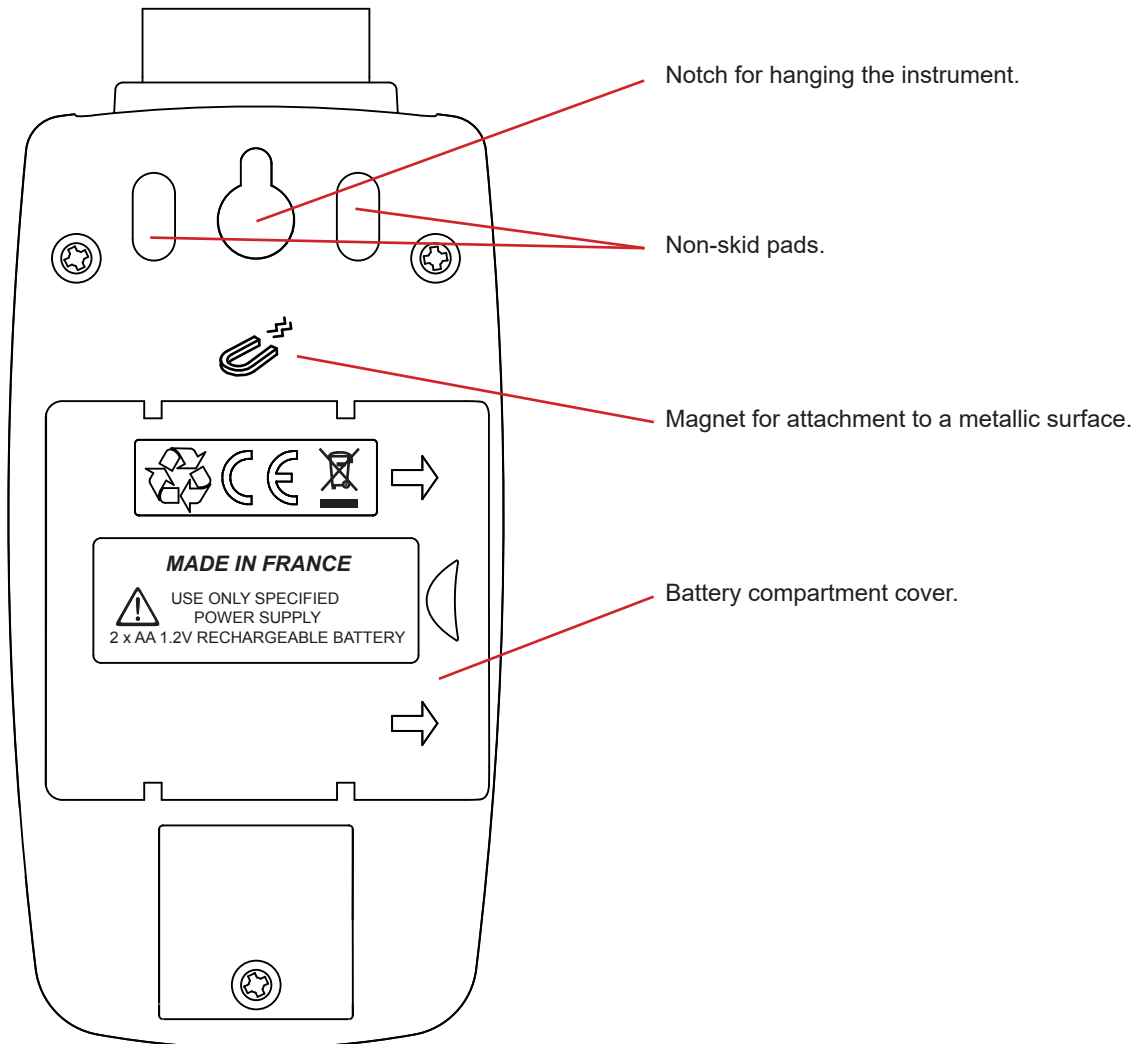

Figure 6

2.4. DISPLAY UNIT

A typical measurement screen looks like this:

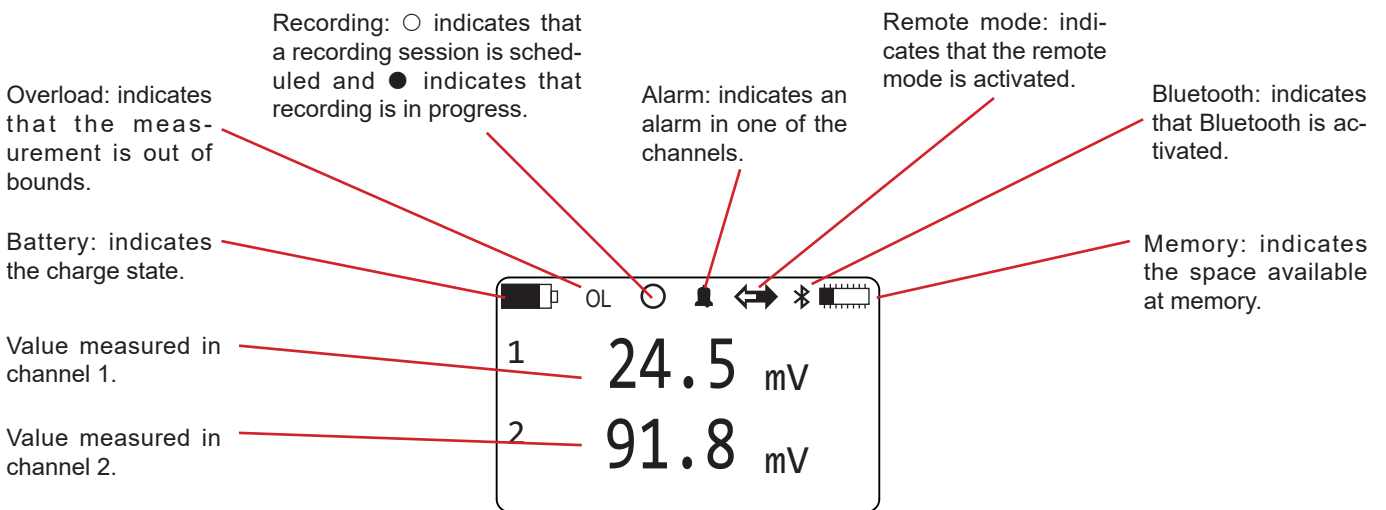

Figure 7

This screen is called **Measurement data**. To open it, press the On/Off $\text{\textcircled{1}}$ key briefly.

3. SETTINGS OF THE INSTRUMENT

Before you use the L452 for the first time, you must configure it. It can be configured either in the local mode (on the keys of the instrument itself) or in the remote mode (using the Data Logger Transfer software).

The parameters to be configured are:

- The language,
- The date and time,
- Activation or non-activation of the Bluetooth link,
- Activation or non-activation of the visibility of the instrument on the Bluetooth network,
- The name of the instrument for the Bluetooth link.

3.1. ORGANIZATION OF THE SCREENS

The screens are organized into 6 categories.

- The measurement screens display the measured data (including the minimum and maximum values) of the two input channels. They can be accessed directly by switching the instrument on.
- The recording screens, used to start, stop, schedule, and configure recording sessions. They can be accessed by pressing the ► key once.
- The channel 1 configuration screens, used to activate the channel and define the type of input, the measurement unit, the transformation coefficient, and the alarm. They can be accessed by pressing the ► key twice.
- The channel 2 configuration screens, used to activate the channel and define the type of input, the measurement unit, the transformation coefficient, and the alarm. They can be accessed by pressing the ► key three times.
- The configuration screens of the instrument, used to define the language, the date and time, and the Bluetooth link. They are also used to clear the memory, to reset the configuration, and to reset the minimum and the maximum. They can be accessed by pressing the ► key four times.
- The instrument information screens, which are read-only and display the serial number, the internal software version, the name of the instrument on the Bluetooth network, and the state of the memory. They can be accessed by pressing the ► key five times.

3.2. CHOOSING A LANGUAGE

- Switch the instrument on by pressing the On/Off Ⓞ key and keeping it pressed until the display unit indicates **POWER ON**. The **Measurement data** screen (see Figure 7) is displayed.

- Press ► 4 times

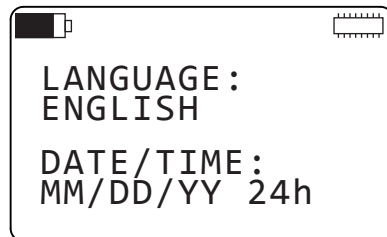

- Press ↵ to select the field.

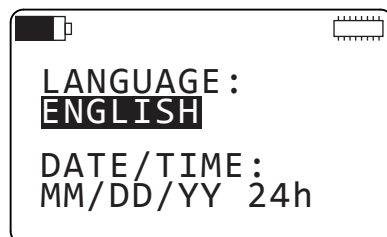

- Press **↵** again to edit the field, then **▲** or **▼** to scroll through the 5 possible languages (English, French, Spanish, Italian, and German), and finally **↵** to validate.

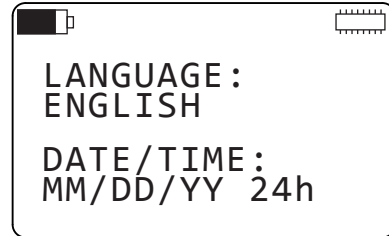

3.3. SETTING THE TIME AND DATE

- From the previous screen, press **↵** to select the field, then **▼** to go to the next field. Press **↵** again to edit the field, then **▲** or **▼** to scroll through the 4 possible choices:
 - MM/DD/YY AM/PM
 - MM/DD/YY 24h
 - DD/MM/YY AM/PM
 - DD/MM/YY 24h

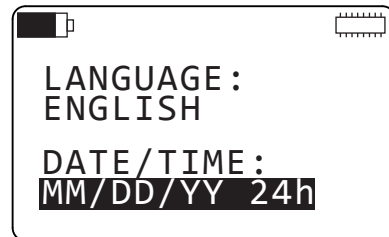

- Press **↵** to validate your choice, then **▼** 3 times.

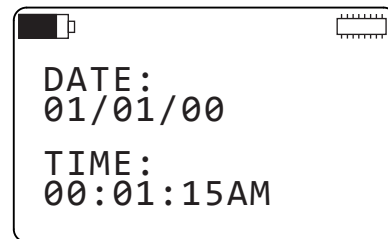

- Press **↵** to select the first field, then **↵** again to edit the field. Then **▲** or **▼** to define the first field.

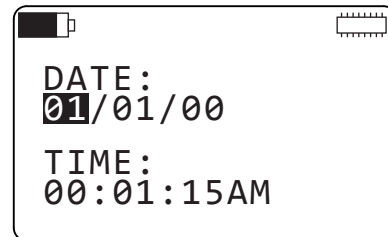

- Press **▶** to go to the next field, then **▲** or **▼** to define the field. Press **▶** again to go to the third field, then **▲** or **▼** to define it. Press **↵** to validate.

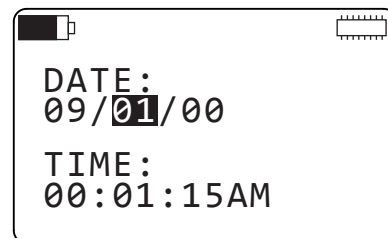

Proceed in the same way for the time.

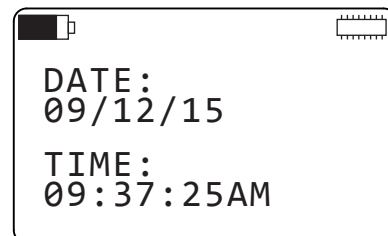

3.4. CONFIGURING THE BLUETOOTH LINK

- From the previous screen, press ▼.

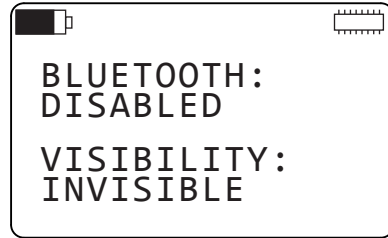

- Proceed as for the previous adjustments to activate the Bluetooth link and make it visible, at least until the instrument is connected to the PC. After that, you may make it invisible once again.

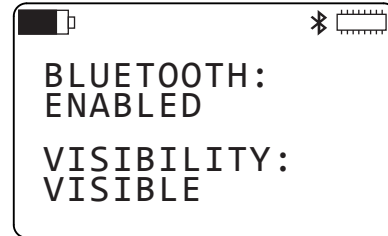

- Press ▼ and the display unit indicates the name under which the instrument will appear on the PC. You can change this name, character by character, using the ◀ and ▶ keys to go from one character to another. The header (L452-) cannot be changed.

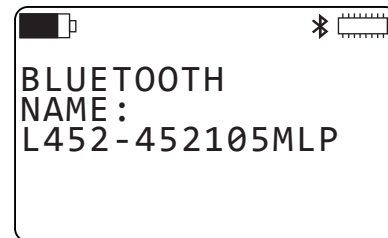

The characters available for the name are all the characters of the ASCII and extended ASCII tables:

- numerals
 - upper-case letters
 - lower-case letters
 - special characters such as: ! " # \$ % & ' () * + , - . / : ; < = > ? @ [\] ^ _ { | } ~
 - special letters such as: Ç ü é â ã ä å ç ê ë è ì î ï Æ etc.
 - other characters such as: ≤ ≥ † ‡ ¶ † ‡ ▣ ▢ • etc.
- The space is the last character. To reach it from !, press ▼.

Holding the ▲ or ▼ key down accelerates the scrolling of the characters.



To return to the **Measurement data** screen, press the On/Off Ⓞ key.

3.5. RESTORING THE ORIGINAL CONFIGURATION

You can cancel all of the changes you have made to the configuration by resetting the instrument. Only the date, the time, and the content of the memory will remain.

- Switch the instrument on, press ► four times and ▼ twice.

- Press ↵ twice, then the ▲ or ▼ key to display **RESET**, and finally ↵ to validate. The instrument asks for confirmation.

- To cancel, press ◀ and ▶ simultaneously. To confirm, press ↵.

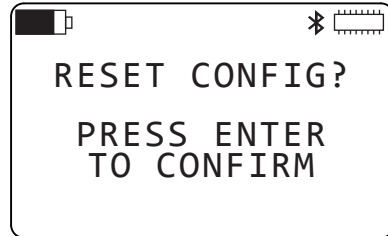
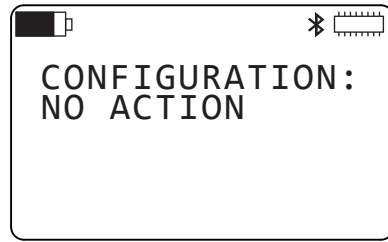

3.6. DISPLAY OF PRODUCT INFORMATION

The information in this menu can be looked up but not modified.

- From the **Measurement data** screen, press ► five times. You can see:
 - The reference of the instrument (L452),
 - The serial number,
 - The internal software version,

- Press ▼. You can see:
 - The name of the instrument for the Bluetooth network,
 - The location of the instrument. The only way to specify this is via the Data Logger Transfer software.

- Press ▼. You can see:
 - The number of recording sessions stored in memory,
 - The available memory.

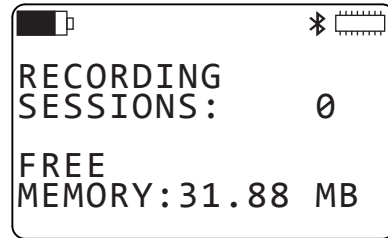
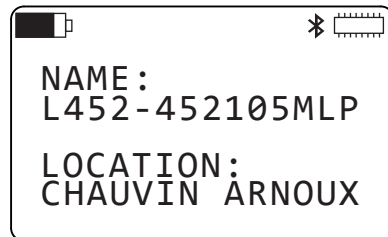
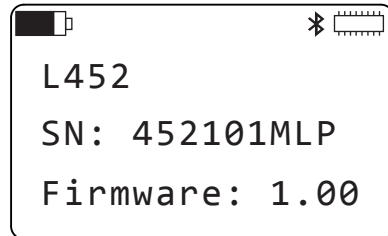

- Press ▼. You can see the default name of the next recording session.
This name is the name of the instrument plus a session number that is incremented each time. It can be modified via the Data Logger Transfer software.

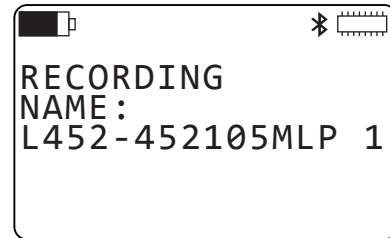

To return to the **Measurement data** screen, press the On/Off ① key.

3.7. SWITCHING THE INSTRUMENT OFF

To switch the instrument off, press the On/Off ① key and hold it down until the instrument displays **POWER OFF**.

4. USE

Once your instrument has been configured, you can use it. You must still:

- Configure the measurement channels,
- Connect the probes, sensors, transmitters, or signal conditioners
- Start a recording session

4.1. CHANGING A PARAMETER

To change a parameter, press \leftarrow ; this changes the first field on the screen that can be modified to reverse video. Use the \blacktriangle \blacktriangledown \blacktriangleleft \blacktriangleright keys to select the field you want to modify, then press \leftarrow again to edit the field. Then use the \blacktriangle or \blacktriangledown key to define the field. If the field comprises several characters, use the \blacktriangleleft or \blacktriangleright key to go from one character to another. When you have finished, press \leftarrow to validate.

The numbers are not changed digit by digit, but more globally.

For example, to go from 0.00 to 85.00, start on the left-hand digit, before the zero, and press \blacktriangle . The digit will be incremented repeatedly. When it reaches 8, shift the cursor to the second digit and change it in the same way. And so on.

For a negative number, start on the left-hand digit, before the zero, and press \blacktriangledown . The digit changes to 00.00, then to -10.00, then -20.00, etc.

4.2. CONFIGURING THE MEASUREMENT CHANNELS

From the **Measurement data** screen (see Figure 7), press \blacktriangleright twice.

- From this screen, you can activate or deactivate measurement channel 1 and choose the type of input:
 - pulse
 - event (discrete)
 - 4-20mA current
 - $\pm 10V$, $\pm 1V$, or $\pm 100mV$ voltage

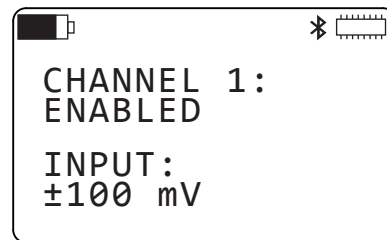

It is not possible to deactivate both channels. If you deactivate channel 2 when channel 1 is already deactivated, channel 1 is automatically reactivated. This makes it impossible to start a recording session with both channels deactivated by mistake.

- Press \blacktriangledown to go to the next screen and enter the unit of channel 1 in 4 characters.

If you do not specify a unit, the default values will be:

- mV for ± 100 mV
- V for $\pm 10V$ and ± 1 V
- mA for 4-20 mA
- Wh for pulse

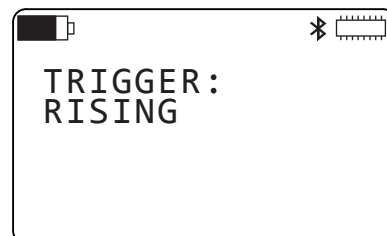
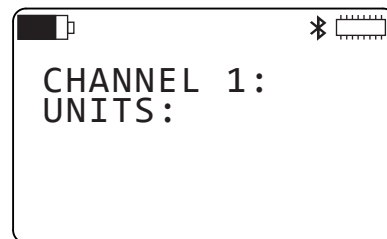

For an event input, you can choose whether triggering is on the positive-going or negative-going front.

- Press ▼. The next 2 screens are used to define transformation coefficients for the current and voltage inputs.

For example, if you use a temperature sensor that delivers 4mA at -10°C and 20mA at 100° C, you enter:

- Input: 4-20 mA
- Unit: degC
- Scale Low: 4.0 mA = -10 degC
- Scale High: 20.0 mA = 100 degC

The instrument then displays the measurement directly in °C.

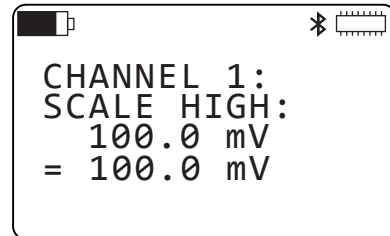
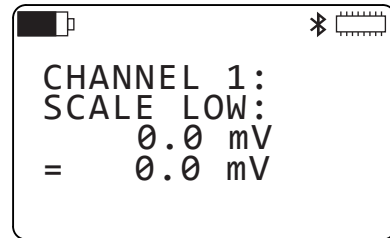

For a pulse input, you can define the number of pulses that corresponds to a certain power, or to something else, since you can change the unit.

For example, if you count the number of teeth on a toothed ring and know that one revolution corresponds to 14 teeth (hence 14 pulses), you can enter "14 pulses = 1 revolution".

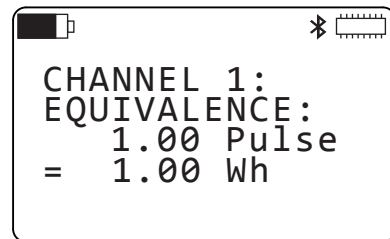

- Press ▼. The next screen is used to define alarms for the current and voltage inputs.

The alarm can be triggered when:

- the measurement is above the high limit,
- the measurement is below the low limit,
- the measurement is either above the high limit or below the low limit,
- the measurement is within the limits.

The alarm can also be deactivated.

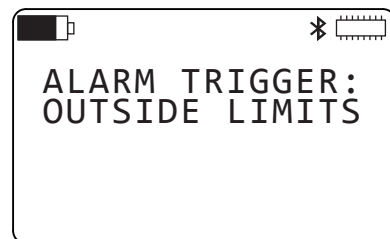

- Press ▼ to define the high and low limits. If you have defined transformation coefficients, they will be displayed directly in the unit defined.

To return to the example of the temperature sensor, the limits will be 100 degC and -10 degC.

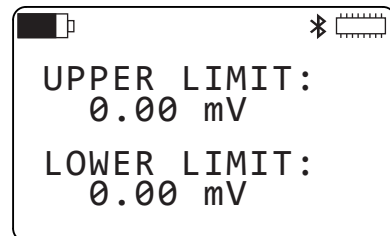

The upper limit must be greater than the lower limit. If you program a lower limit that is above the upper limit, the instrument sets both limits to the same value.

- Press ► to go to the configuration of channel 2 and proceed as for channel 1.

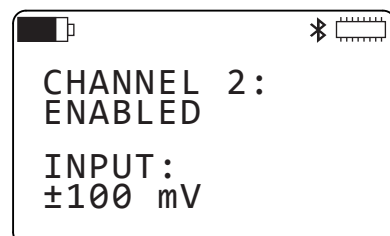

Both measurement channels must have the same type of input. If you set input 2 to pulse and input 1 was voltage, channel 1 automatically changes to pulse.

4.3. CONNECTING PROBES, SENSORS, TRANSMITTERS, OR SIGNAL CONDITIONERS

The L452 Data Logger operates with a great variety of probes having outputs of the following type:

- Voltage: $\pm 100\text{ mV}$, $\pm 1\text{ V}$ or $\pm 10\text{ V}$
- Current: $4 - 20\text{ mA}$
- Pulse: $\pm 10\text{ V}$
- On/Off (discrete): $\pm 10\text{ V}$

Place the connecting strip provided on the terminal block of the instrument and push it home.

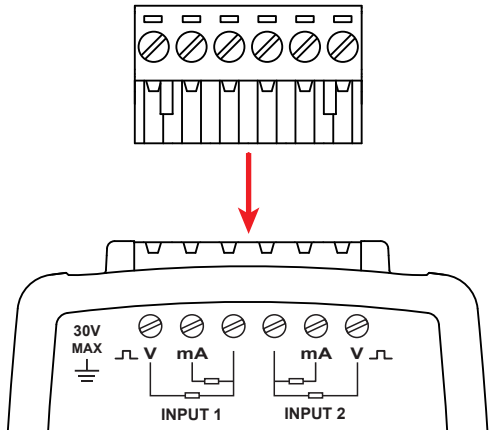

Figure 8

Then connect the probes.

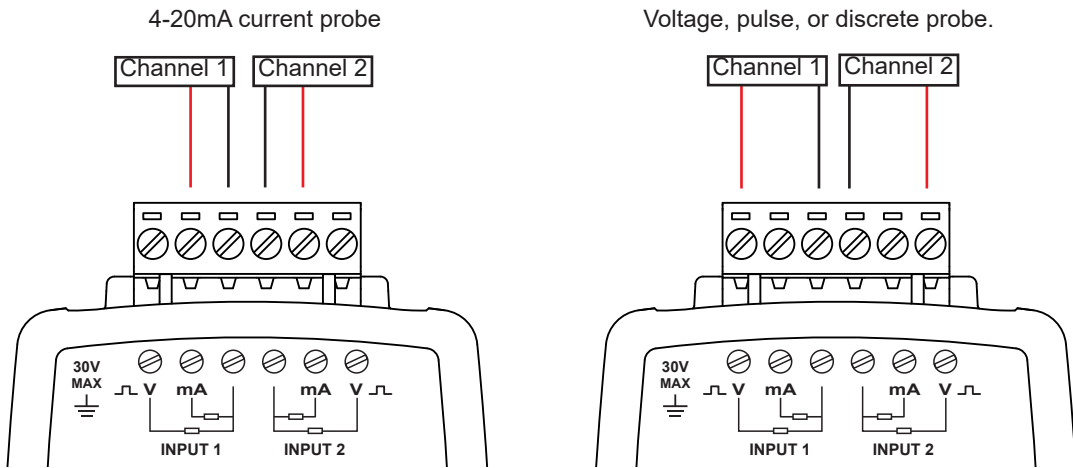

Figure 9

Use a small flat blade screwdriver to unscrew the screws of the terminal block. Insert the wires, then screw the screws back in so that the wires cannot be pulled out of the connector.

4.4. DISPLAY OF THE MEASUREMENTS

4.4.1. CURRENT OR VOLTAGE INPUTS

Once the probes have been connected, switch the instrument on. The display unit indicates the values on the measurement inputs.

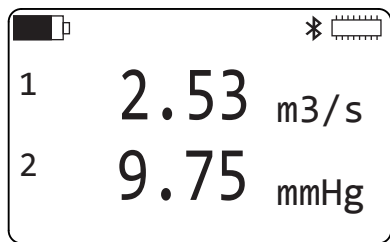

Figure 10

If the measurement from one of the channels is outside of the measurement range, the instrument displays OL. Check that the probe you have connected delivers the right signal and that the type of input is the right one.

- Press ▼ to display the minimum and maximum of channel 1.
- Press ▼ to display the minimum and maximum of channel 2. The values displayed on this screen are not the instantaneous values displayed on the Measurement data screen, but averages over the storage period.

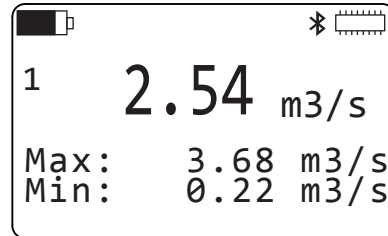
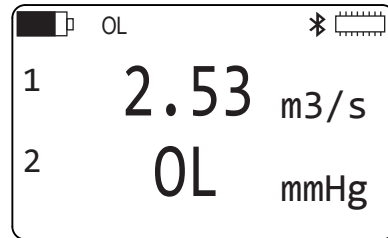

Figure 11

The minimum and maximum are reset:

- at the beginning of a recording session,
- when the type of input is changed,
- when the sampling period or the storage period is changed,
- when the instrument is off.

You can also reset them manually.

From the **Measurements data** screen (see Figure 10), press ► four times, then ▼ once.

Choose **Reset** for Min/Max. The instrument asks for confirmation. To cancel, press ◀ and ► simultaneously. To confirm, press ↵.

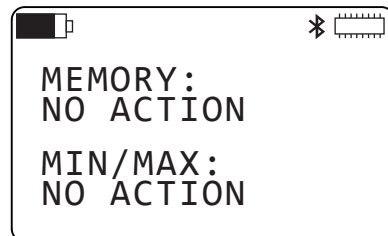

4.4.2. PULSE INPUTS

Instead of the minimum and maximum screens, the instrument indicates the period of storage corresponding to the maximum value.

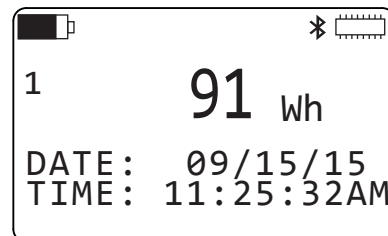

4.4.3. EVENT INPUTS

The **Measurement data** screen takes a different form.

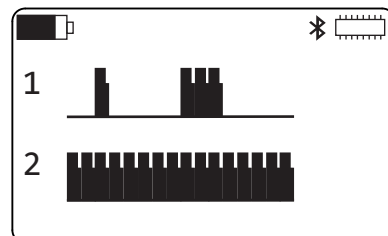

- Press ▼ to display the graphic representation of the last event of channel 1.

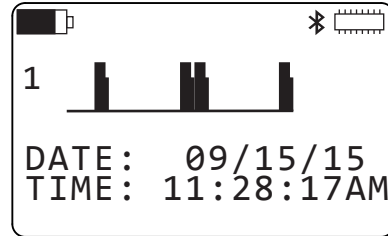

4.5. RECORDING DATA

The L452 can store up to 16 million measurements in up to 1024 recording sessions.

The size of a recording session depends on the storage period and on the duration of the record. This last is limited by the battery life of the instrument.

The recorded sessions can be uploaded to a PC (see §5) to be saved, displayed, and analysed.

Before starting a recording, make sure that there is enough space in memory. If the memory is full (■■■■■) or nearly full (■■■■), you must empty it (see §4.6) to be able to make new records.

You can also look at the number of recording sessions (see §3.6), the maximum being 1024, and the available memory size, the maximum being 31.88 MB.

- From the **Measurement data** screen (see Figure 10), press ►.

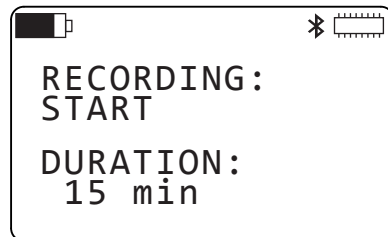

- Press ▼.

Define the sampling period, between 200ms and 1 minute. The possible values are: 200ms, 400ms, 600ms, 800ms, 1 to 60 seconds, and 1 minute.

Then define the storage period, between 200ms and 1 hour. The possible values are: 200ms, 400ms, 600ms, 800ms, 1 to 60 seconds, and 1 to 60 minutes.

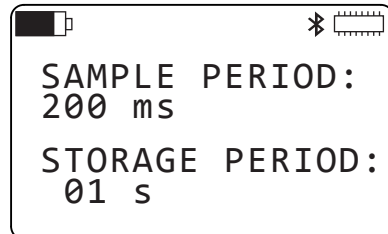

The storage period must be longer than the sampling period. If you set the storage period to a smaller value than the sampling period, the sampling period is automatically changed so as to be equal to the storage period.

For an event input, this screen is read-only. The sampling period is fixed: 62.5ms.

The samples are averaged over the storage period, then recorded and displayed on the Min/Max screen (see Figure 11).

The shorter the sampling period, the more measurements the instrument must make and the shorter its life between charges.

The shorter the storage period, the more data the instrument must record: the averaged measurements, the minimum and maximum values.

If the sampling and storage periods are different, the instrument must record five times as much data. In that case, it is best to choose a storage period at least five times as long as the sampling period.

- Press ▲. Choose a recording duration between 1 minute and 99 weeks. Bear in mind that the life between charges of the instrument is not that long (see § 6.3).



The recording time must be at least as long as the storage period.

You can start recording immediately by pressing ↵ 3 times. The ● symbol is displayed.

Proceed in the same way if you want to stop recording before the end of the programmed recording time.

If recording fails to start, it means that there is not enough available space in memory for the recording. You must clear the memory (see §4.6) to be able to record your session.

- You can also program the start- and end-of-recording times. Press ▼ twice and choose the starting and stopping times. The duration is adjusted automatically. Or program the duration and the ending time is adjusted.

- Press ▼. Change the text **Start** to **Schedule** and validate by pressing ↵. Recording is pending and will begin at the scheduled time. The ○ symbol is displayed.

To cancel a programmed recording session, press ↵ three times.

You cannot switch the instrument off while recording is in progress. If you press the On/Off Ⓚ key, the instrument displays the screen opposite and does not switch off.

But it is possible to switch it off if a recording session is programmed. The instrument will switch itself back on for the duration of the recording, then switch off automatically.

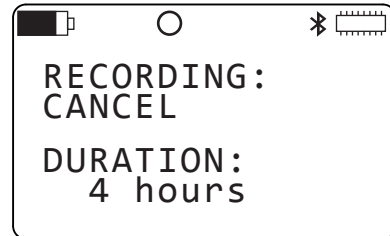
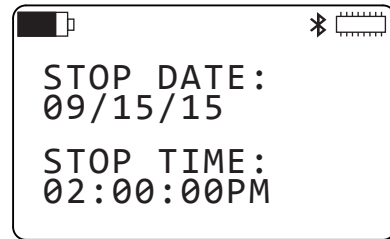
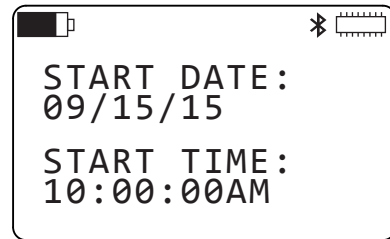
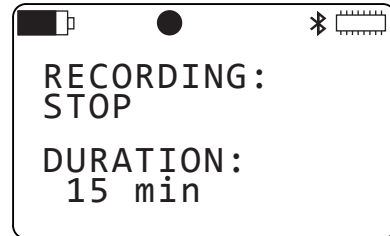
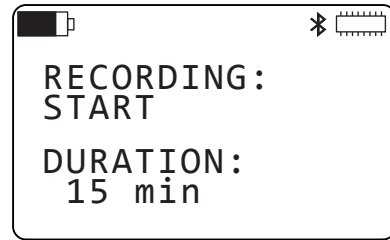

It is not possible to modify the configuration while recording is in progress. To change it, you must stop recording.

4.6. CLEARING MEMORY

If you want to preserve recorded sessions, transfer them to a PC (see §5) before clearing the memory of the instrument.

From the **Measurement data** screen (see Figure 10), press ► 4 times, then ▼ once.

Choose **Erase** for the memory.

The instrument asks for confirmation.

To cancel, press ◀ and ▶ simultaneously.

To confirm, press ↵.

The instrument displays the progress of the erasure of the memory, which can take several minutes.

During this time, the keys of the instrument are inoperative.

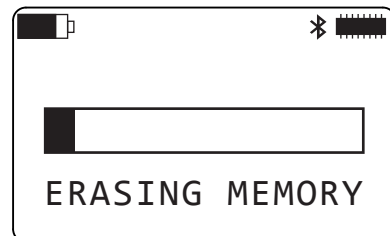
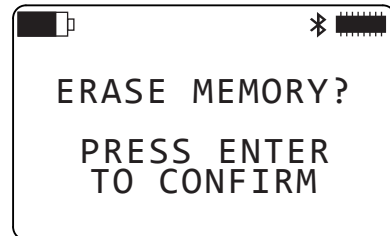
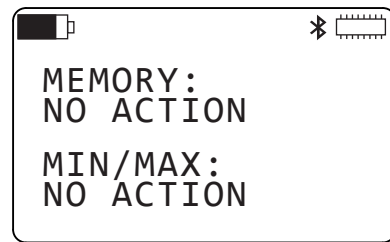

5. DATA LOGGER TRANSFER SOFTWARE

5.1. FUNCTIONS

The Data Logger Transfer software is used to:

- Connect the instrument to the PC, using either USB or Bluetooth.
- Configure the instrument: choose the language, set the date and time, activate or deactivate the Bluetooth link (the latter only if connected by USB), activate or deactivate visibility of the instrument on the Bluetooth network and give it a name, etc.
- Configure the measurement channels.
- Configure the records: choose their names, their duration, their start and end dates.
- Start and stop recording.

Data Logger Transfer is also used to upload recorded sessions to a PC to save them, display them, or analyse them. And finally to export them to a spreadsheet and view the corresponding curves.

5.2. INSTALLATION



Do not connect the instrument to the PC until the software and driver have been installed.

- Insert the CD in the CD-ROM drive.

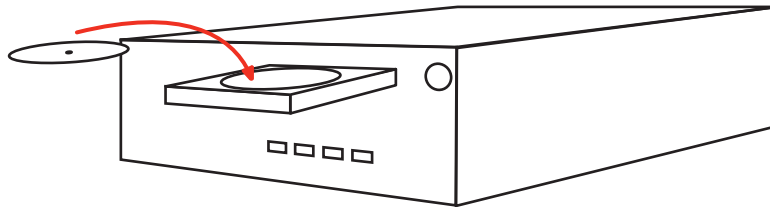

Figure 12

If automatic execution is activated, the program starts automatically.

If not, select **Setup.exe**

- Then follow the instructions to install the program.



To use the Data Logger Transfer software, refer to its help function.

5.3. USB CONNECTION

- Once the software and the driver have been installed, you can connect the instrument to the PC.

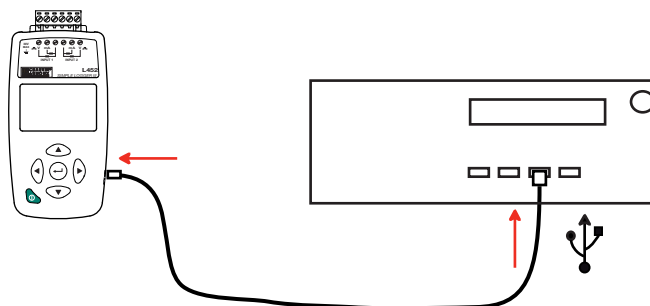



Figure 13

5.4. BLUETOOTH COMMUNICATION

- Make sure that the Bluetooth symbol  is in fact displayed on the screen of the instrument. Otherwise, refer to §3.4 to activate the Bluetooth link and make the instrument visible on the Bluetooth network.



If Bluetooth fails to activate, the voltage of the batteries is too low. Recharge them (see §1.4)

- If your PC does not have a Bluetooth  connection, install a USB-Bluetooth adapter. Then, in the Windows bar, look for the Bluetooth logotype, right-click on it, and choose **Add a peripheral**.

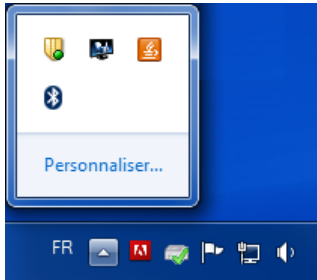

Figure 14

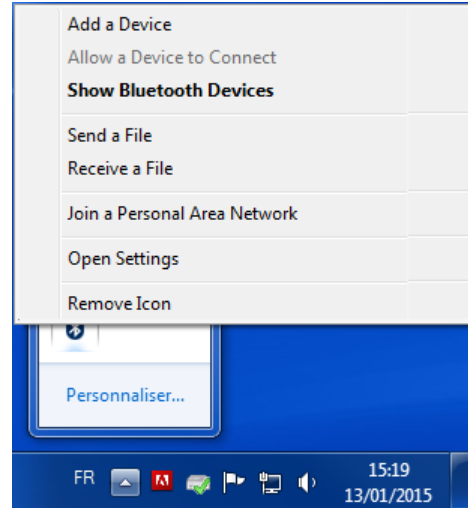

Figure 15

- The PC searches its environment for Bluetooth-compatible instruments. When the L452 is detected, select it and click on **Next**.

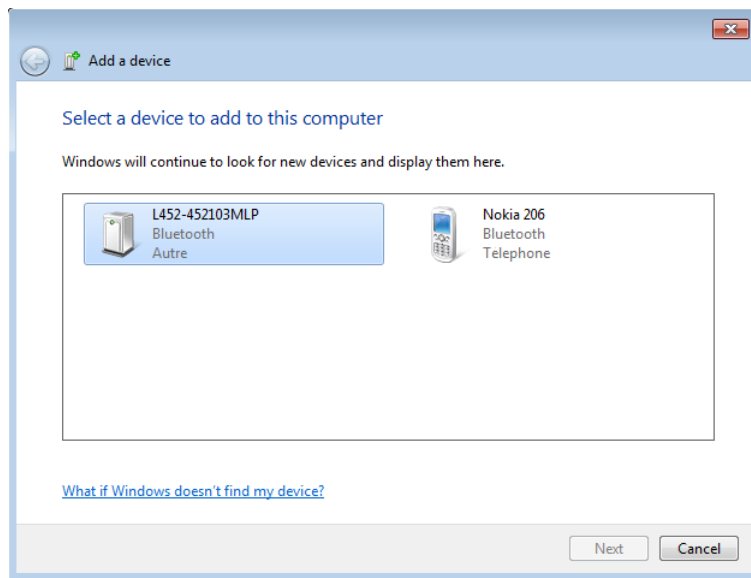

Figure 16

- If a pairing code is requested, enter 1111.

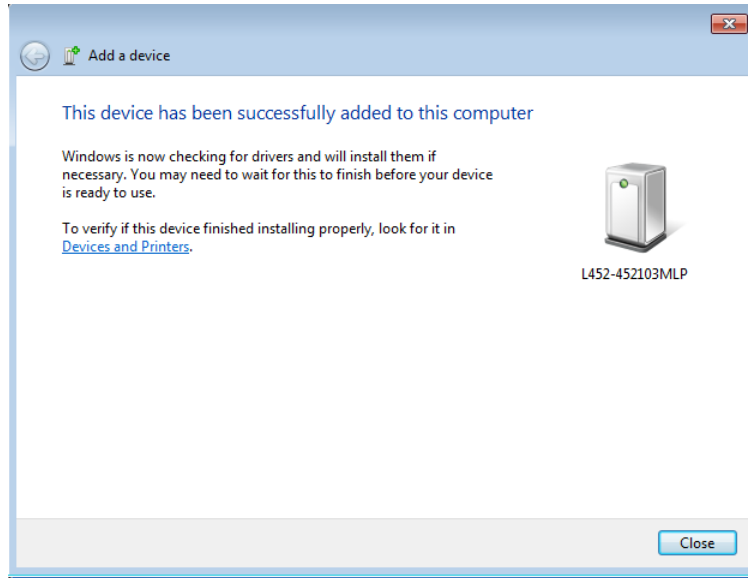

Figure 17

- For more security, then make the instrument invisible on the Bluetooth network (see §3.4). It will then not appear in the lists of available peripherals on other computers within its range.

5.5. REMOTE MODE

The L452 can operate in 2 modes:

- The local mode (see §§3 and 4), which can be used to configure the instrument, configure the measurements, display the measurements, start and stop recording, and clear the memory.
- The remote mode is used to control the instrument from a PC. In addition to everything you can do in the local mode, the remote mode lets you assign a name to the location of the instrument and name the recordings, and to upload the records for subsequent processing. The measurements are then displayed directly on the PC.

The remote mode can be automatic (the instrument connects to the PC as soon as it is switched on) or manual.

When the instrument is in the remote mode, the  symbol is displayed on the screen.

The configuration of the instrument can be locked from the PC. This makes it impossible to change it in the local mode, even if the instrument is disconnected from the PC.

If you have no way of unlocking the configuration from a PC, you can switch the instrument off. Effect a long press on the On/Off  key. The instrument displays **Remote Mode**. Keep pressing and the instrument will end by switching off. When you switch it back on, it will be in the local mode.

6. TECHNICAL CHARACTERISTICS

6.1. REFERENCE CONDITIONS

Quantity of influence	Reference values
Temperature	20 ± 3 °C
Relative humidity	45 to 55%RH
Internal supply voltage	2.4 ± 0.2V
External supply voltage	110 to 240V 50/60Hz
Electric field	< 1V/m
Magnetic field	< 40A/m

The **intrinsic uncertainty** is the error specified for the reference conditions. It is expressed as a percentage of the reading ± display points.

6.2. ELECTRICAL CHARACTERISTICS

6.2.1. TYPES OF INPUT

Type of input	Measurement range	Resolution	Intrinsic uncertainty	Input impedance	Max. sampling rate
DC voltage	± 100mV	0.1mV	±(0,5% + 1 ct)	1 MΩ	5 samples / s
	± 1V	1mV	±(0,5% + 1 ct)	1 MΩ	5 samples / s
	± 10V	10mV	±(0,5% + 1 ct)	1 MΩ	5 samples / s
DC current	4 to 20mA	0.01mA	±(0,25% + 5 ct)	100 Ω	5 samples / s
Pulse	± 10V	-	-	-	100 samples / s
Event	± 10V	-	-	1 MΩ	16 samples / s

Output voltage for the pulse input: 3.3V (with 1 MΩ pull up resistor);

6.3. POWER SUPPLY

The instrument can be powered:

- by rechargeable batteries (2 x 1,2 V 2,400mAh NiMH)
- by mains (110 to 240 V, 50/60Hz), via a USB cable.

When the instrument is off (and not on standby), pressing the On/Off  key displays the remaining capacity of the batteries.



To save the batteries, the instrument switches to standby at the end of 20 minutes with no key press. This does not prevent the instrument from continuing to make measurements. Simply press the  key to switch it back to full on.

The maximum consumption of the L452 is 2.5W.

When the instrument is off, its consumption is 0.4mA and its battery life is 270 days.

Consumption / life			
Sampling rate	200 ms	400 ms	60 s
Screen lit	6 mA / 18 days	5 mA / 21 days	4 mA / 27 days
Screen off	3 mA / 36 days	2 mA / 54 days	0,4 mA / 270 days

All consumption values are with Bluetooth deactivated.

Maximum: 2.5 W

6.4. MEMORY

The size of the memory is 32MB.

The L452 can record up to 16 million measurements in up to 1024 sessions.

6.5. BLUETOOTH

Bluetooth 2.1

Class 1

Range: 100m in line of sight.

Default pairing code: 000

Nominal output power: +15 dBm

Nominal sensitivity: -82 dBm

Rate: 115.2 kbits/s

6.6. USB

USB 2.0

6.7. ENVIRONMENTAL CONDITIONS

%RH

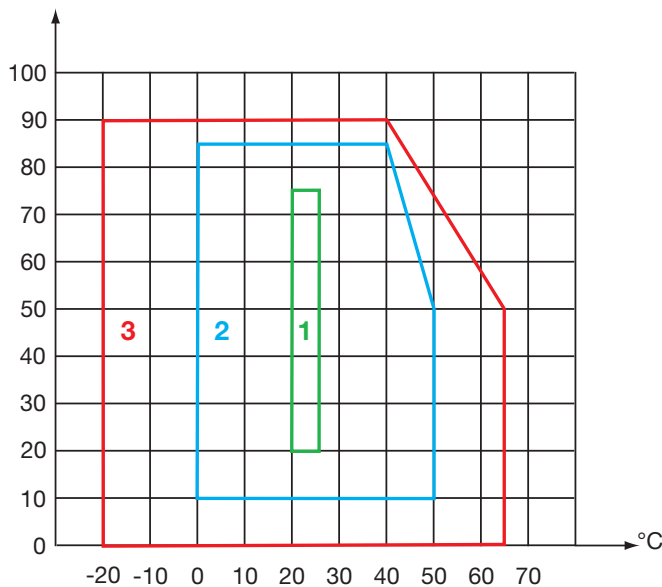

- 1: Range of reference
- 2: Range of operation
- 3: Range of storage (without the batteries)

Indoor use.

Altitude < 2,000m

Degree of pollution 2

6.8. MECHANICAL CHARACTERISTICS

Dimensions (L x P x H) 125 (138 with the connecting strip) x 66 x 33 mm
Weight approximately 210g with the connecting strip.

Ingress protection IP40 per IEC 60 529.
IK 04 per IEC 50102

Drop test per IEC 61010-1

6.9. COMPLIANCE WITH INTERNATIONAL STANDARDS

The device is compliant per IEC 61010-1 and IEC 61010-2-030.

6.10. ELECTROMAGNETIC COMPATIBILITY (CEM)

The instrument is compliant with standard IEC 61326-1.

7. MAINTENANCE



Except for the batteries, the instrument contains no parts that can be replaced by personnel who have not been specially trained and accredited. Any unauthorized repair or replacement of a part by an “equivalent” may gravely impair safety.

7.1. CLEANING

Disconnect the unit completely.

Use a soft cloth, dampened with soapy water. Rinse with a damp cloth and dry rapidly with a dry cloth or forced air. Do not use alcohol, solvents, or hydrocarbons.

7.2. REPLACING THE BATTERIES

If the batteries no longer take a charge, in other words, if they discharge too rapidly for you to be able to make recordings, they must be replaced.

Withdraw the old batteries (see §1.4) and replace them with new ones.



Spent batteries must not be treated like ordinary household wastes. Take them to the appropriate collection point for recycling.

7.3. UPDATING THE EMBEDDED SOFTWARE

With a view to providing, at all times, the best possible service in terms of performance and technical improvements, Chauvin Arnoux offers you the possibility of updating the internal software of this instrument by downloading, free of charge, the new version available on our web site.

See you on our site:

<http://www.chauvin-arnoux.com>

In **Support**, click on **Download our software** and enter the name of the instrument.

Connect the instrument to your PC using the USB cord provided.



Updating the embedded software may cause the loss of the recorded data. As a precaution, save the recorded data to a PC before updating the embedded software.

Once the update is over, check that you in fact have the new software version (see §3.6) and check the time (see §3.3).

8. WARRANTY

Except as otherwise stated, our warranty is valid for **twelve months** starting from the date on which the equipment was sold. Extract from our General Conditions of Sale provided on request.

The warranty does not apply in the following cases:

- Inappropriate use of the equipment or use with incompatible equipment;
- Modifications made to the equipment without the explicit permission of the manufacturer's technical staff;
- Work done on the device by a person not approved by the manufacturer;
- Adaptation to a particular application not anticipated in the definition of the equipment or not indicated in the user's manual;
- Damage caused by shocks, falls, or floods.

FRANCE

Chauvin Arnoux Group
190, rue Championnet
75876 PARIS Cedex 18
Tél : +33 1 44 85 44 85
Fax : +33 1 46 27 73 89
info@chauvin-arnoux.com
www.chauvin-arnoux.com

INTERNATIONAL

Chauvin Arnoux Group
Tél : +33 1 44 85 44 38
Fax : +33 1 46 27 95 69

Our international contacts
www.chauvin-arnoux.com/contacts

