

PREFACE

This User's Manual provides you with information necessary for use of the K3GN series of digital panel meters.

Please read this manual carefully to ensure correct and efficient use of the product.

Keep this manual handy for future reference.

General Precautions

If contemplating using the product in the following environments or for the following equipment, first contact a sales representative of the company and then accept responsibility for incorporating into the design fail-safe operation, redundancy, and other appropriate measures for ensuring reliability and safety of the equipment and the overall system.

- (1) Environments deviating from those specified in this manual
- (2) Nuclear power control systems, traffic (rail car/automobile/aircraft) control systems, medical equipment, amusement equipment, and rescue and security equipment
- (3) Other equipment that demands high reliability, including those related to the safety of life and property

About the Contents of the Manual

- (1) Any reproduction, full or in part, of the manual is prohibited without prior written permission from the company.
- (2) Specifications in the manual may be subject to change without notice.
- (3) Information in the manual has been carefully checked for accuracy. If finding any suspicious or erroneous descriptions in the manual, however, you are kindly requested to contact a branch office of the company. In such a case, please let us know the Cat. No. shown on the front cover of the manual.

Signal Words and Safety Notices

● Signal Words

In this manual, safety notices are divided into WARNING and CAUTION according to the hazard level.

As both of WARNING and CAUTION notices contain important information for ensuring safety, be sure to observe them.

WARNING

A signal word indicating a potentially hazardous situation which, if not avoided, could result in death or serious injury.

CAUTION

A signal word indicating a potentially hazardous situation which, if not avoided, may result in minor or moderate injury or property damage.

● Safety Notices

WARNING

Do not touch live terminals of the product.
Doing so may result in electrical shock.
Do not touch live terminals of the product with a screwdriver.
Doing so may result in electrical shock.
Do not disassemble, repair, or modify the product.
Doing so may result in electrical shock, fire, or malfunction.

CAUTION

Do not allow pieces of metal or wire clippings to enter the product.
Doing so may result in electrical shock, fire, or malfunction.
Do not use the product in flammable or explosive atmospheres.
The service life of the output relays varies depending on the switching capacity and switching conditions.
Consider the actual operating conditions and use the product within the rated load and electrical service life.
Otherwise, contact welding or burnout may result.
Do not overload the product.
Doing so may damage or burn out the product.
Always maintain the power supply voltage within specifications.
Otherwise, the product may be damaged or burnt out.
Perform correct setting of the product according to the application.
Failure to do so may cause unexpected operation of the overall system, resulting in damage to the system or personal injury.
Take appropriate safety measures in case the product malfunctions.
Otherwise, a serious accident could occur if a malfunction of the product prevents comparative output from being generated.
Tighten the terminal screws to a recommended tightening torque of 0.5 N·m.
Loose screws may result in product failure or malfunction.

Safety Precautions

● **Observe the following precautions to ensure safety.**

- (1) Do not connect anything to unused terminals.
- (2) Be sure to check each terminal for correct number and polarity before connection. Incorrect or reverse connection may damage or burn out internal components of the product.
- (3) Do not install the product in such an area that is subject to the following:
 - Dust or corrosive gases (e.g., sulfuric or ammonia gas)
 - Condensation or icing due to high humidity
 - Outdoor conditions or direct sunlight
 - Strong vibrations or mechanical shock
 - Water flooding or oil splashes
 - Direct heat radiation from any heat source
 - Rapid temperature changes
- (4) Do not block heat dissipation from the product, i.e., allow sufficient space for heat dissipation.
Do not block the ventilation holes on the back of the product.
- (5) Do not use paint thinner for cleaning. Use commercially available alcohol.
- (6) Use a 24VDC power supply. Be sure that the rated voltage is reached within 2 seconds after the power is turned ON.
- (7) Use the product within the specified ambient temperature and humidity ranges.
When installing the product inside a panel, be sure that the temperature around the product (not around the panel) does not exceed 55°C.
If the product is subject to radiant heat, use a fan or other heat removal measures so that the temperature of the surface of the product exposed to the radiant heat does not exceed 55°C.
- (8) Store the product within the specified ambient temperature and humidity ranges.
- (9) Do not lay heavy objects on the product during use or storage.
Doing so may deform or deteriorate the product.
- (10) Conduct aging for at least 15 minutes after turning ON the power for correct measurement.

Installation and Noise Prevention Tips

● Installation

- (1) Install the product in a horizontal position.
Inclined installation may hinder ventilation around the product, resulting in deterioration in measuring accuracy of the product.
- (2) Mount the product to a panel that is 1 to 5 mm thick.
Mounting the product to a thinner panel will reduce the resistance to shock and vibration and may result in a malfunction of the product.

● Noise prevention

- (1) Install the product as far as possible from devices that generate strong, high-frequency fields (such as high-frequency welders or sewing machines) or surges.
- (2) Attach surge absorbers or noise filters to nearby devices that generate noise (particularly motors, transformers, solenoids, magnet coils, and other devices that have a high inductance component).
- (3) To prevent inductive noise, separate the terminal block wiring for the product from high-voltage or high-current power lines. Do not route the wiring for the product in parallel with or tie it in a bundle with power lines.
Use of separate wiring ducts or shielded cables will also be effective for noise prevention.
- (4) When using a power supply noise filter, check that the filter is suitable for the supply voltage and current ratings and then install it as close as possible to the product.
- (5) Televisions, radios, or other wireless devices may suffer reception interference if placed near the product.

<Examples of noise prevention schemes>

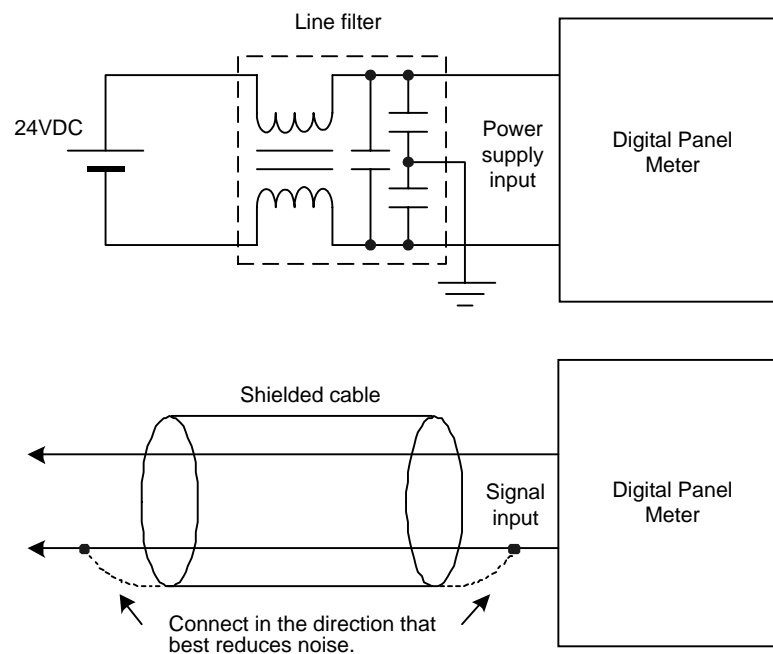

Alphabetic Characters for Setting Data

This manual uses the following alphabetic characters for setting data.

A	b	c	d	e	f	g	h	i	j	k	l	m
A	B	C	D	E	F	G	H	I	J	K	L	M

n	o	p	q	r	s	t	u	v	w	x	y	z
N	O	P	Q	R	S	T	U	V	W	X	Y	Z

Table of Contents

	PREFACE.....	I
	General Precautions	I
	Signal Words and Safety Notices.....	II
	Safety Precautions.....	IV
	Installation and Noise Prevention Tips	V
	Alphabetic Characters for Setting Data	VI
CHAPTER 1	INTRODUCTION.....	1
	1.1 Main Features	2
	1.2 Model Number Legend.....	4
	1.3 I/O Circuits	5
	1.4 Parts Name and Function	7
CHAPTER 2	INSTALLATION AND CONNECTION	9
	2.1 Installation	10
	2.2 I/O Terminal Connections.....	12
CHAPTER 3	APPLICATION EXAMPLES.....	15
	3.1 Monitoring the Remaining Quantity of Soup.....	16
	3.2 Monitoring the Load Current of a Motor	18
	3.3 Monitoring the Quantity of Dust.....	20
	3.4 Monitoring the Internal Pressure of a Tank	22
	3.5 Monitoring the Rotational Speed of a Motor	24
	3.6 Using the Product as a Digital Indicator for PLC	26
CHAPTER 4	INITIAL SETTING.....	29
	4.1 Using the Product as a process meter.....	30
	4.2 Using the Product as a Tachometer.....	32
	4.3 Using the Product as a Digital Indicator for PLC Data.....	34
CHAPTER 5	OPERATION	37
	5.1 Levels.....	38
	5.2 Moving among Levels	39
	5.3 Parameters.....	42
	5.4 Set Values	44
	5.5 Operation Level	45
	5.6 Communication Writing Control	47
	5.7 Key Protect Setting	48

5.8	Selecting an Input Type.....	50
5.9	Selecting an Analog Range	51
5.10	Selecting an Input-pulse Frequency Range	52
5.11	Specifying the Scaling Factor for Analog Input/Digital Data Display	53
5.12	Specifying the Scaling Factor for Input Pulse Frequency	55
5.13	Specifying the Decimal Point Position.....	58
5.14	Selecting the Output Operating Action	59
5.15	Specifying Communication Parameters	60
5.16	Clearing All Parameters	62
5.17	Specifying the Number of Measurements for Averaging.....	63
5.18	Specifying the Function of the Event Input.....	64
5.19	Specifying the Hysteresis	66
5.20	Specifying the Auto-zero Time	68
5.21	Specifying the Startup Compensation Time	70
5.22	Changing the Display Color.....	72
5.23	Changing the Display Auto-return Time.....	74
5.24	Changing the Move-to-Protect-Level Time	76
5.25	Changing the Send Waiting Time	78

CHAPTER 6 FUNCTION DESCRIPTION..... 81

6.1	Measurement	82
6.2	Scaling.....	84
6.3	Auto-zero/Startup Compensation	86
6.4	Average Processing	87
6.5	Event Input/Pulse Input.....	88
6.6	Process Value Hold	89
6.7	Forced-zero.....	90
6.8	Comparative Output	91
6.9	Hysteresis	92
6.10	Display Color Change	93

CHAPTER 7 COMMUNICATIONS 95

7.1	Communication Protocols	96
7.2	Data Format Structure	97
7.3	Structure of Command/Response Text.....	99
7.4	Variable Area	100
7.5	Read from Variable Area	101
7.6	Write to Variable Area	102
7.7	Operation Instructions	103
7.8	Setting Areas	104
7.9	Commands and Responses	105
7.10	Variable Area Map	113
7.11	Communications Control Flow	116
7.12	Programming Example.....	121

CHAPTER 8	USER CALIBRATION	125
8.1	User Calibration	126
8.2	User Calibration Processes.....	128
CHAPTER 9	TROUBLESHOOTING GUIDE	131
9.1	Error Indications	132
9.2	Troubleshooting Table.....	133
	APPENDIX	135
	Specifications	136
	Parameter List	139
	ASCII Code Table	140

CHAPTER

1

INTRODUCTION

This chapter provides an overview of the product.

1.1	Main Features	2
1.2	Model Number Legend	4
1.3	I/O Circuits	5
	Input Circuit Diagrams/Output Circuit Diagrams/ Internal Block Diagram	
1.4	Parts Name and Function	7

1.1 Main Features

The K3GN is a digital panel meter that is capable of converting an input signal into a digital value and displaying it on the main indicator.

The main features of the product include the following.

Measurement

This feature measures an input signal and displays it as a digital value.

An analog value (voltage/current), a rotational speed (pulses), or digital data received via communication function can be selected as an input signal.

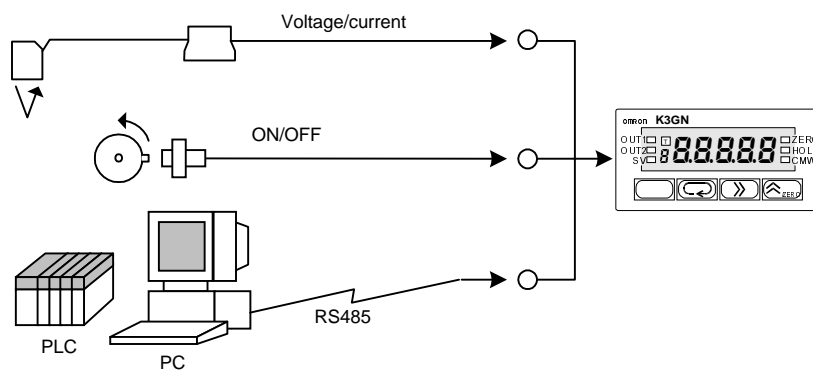

Scaling

This feature converts an input signal into a desired physical value.

The figure on the right shows a scaling example where input signals from a pressure sensor ranging from 4 to 20 mA are converted into values ranging from 0 to 100 (kPa). Scaling will enable you to handle physical quantities easily and intuitively.

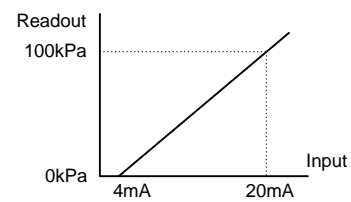

Comparative Output

This feature compares a scaled (process) value with a programmed OUT set value and produces output according to the comparison result.

This is useful in monitoring various systems for malfunction or determining whether products are within acceptance limits.



Three types of comparative outputs are available: those produced at the OUT upper-limit value, the OUT lower-limit value, and both the OUT values.

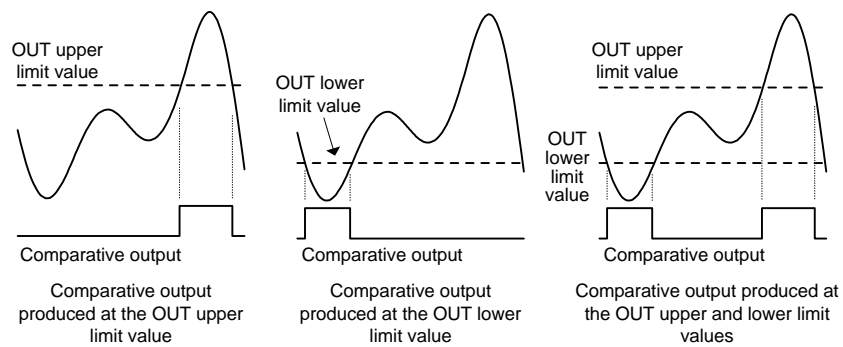

Process Value Hold

This feature enables a process value to be held while the external event input stays ON. The outputs are also retained.

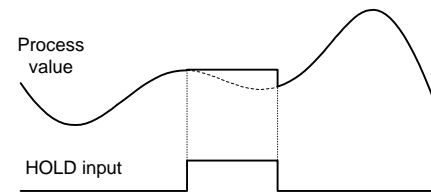

Forced-zero

This feature shifts a process value to zero, and can be used to evaluate and display the deviation of a process value from a reference value. The forced-zero function can be activated by using the  key on the front panel, via the event input terminal, or communications.

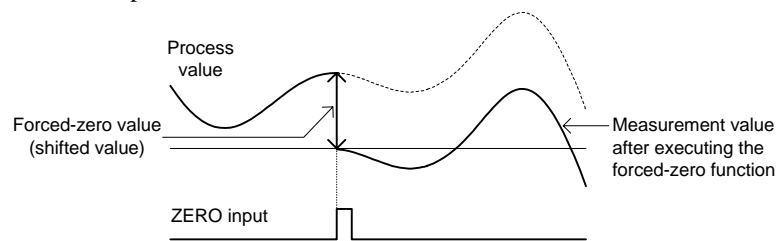

Display Color Change

This feature allows programming of the display color. In the example shown below, the display color is programmed so that it changes from green to red when a comparative output turns ON. The display color can also be programmed so that it changes red to green or is fixed to red or green.

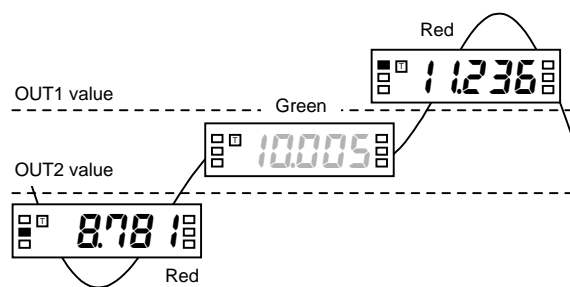

Communication

This feature allows the host PC to read process values from the product or read/write various parameter settings from/to the host PC. The host PC provides logging of measured data and remote control to the product.

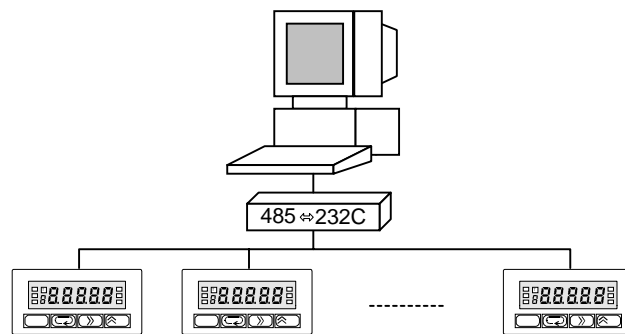

1.2 Model Number Legend

K3GN-□□□-□ 24VDC

① ② ③ ④ ⑤ ⑥

Model name

Symbol	Description
K3GN	1/32 DIN Digital Panel Meter

Pulse input type

Symbol	Description
N	NPN input
P	PNP input

Analog input type

Symbol	Description
D	DC voltage/current input

Output type

Symbol	Description
C	2 relays (2 SPST-NO)
T1	3 NPN open collectors
T2	3 PNP open collectors

Communication

Symbol	Description
(Non)	(Not available)
FLK	RS-485 interface

Power supply

Symbol	Description
24VDC	24VDC

Input type	Output	Communication	Power supply	Model
DC voltage/ current or NPN	2 relays (2 SPST-NO)	None	24VDC	K3GN-NDC 24VDC
		RS-485		K3GN-NDC-FLK 24VDC
	3 NPN open collectors	None		K3GN-NDT1 24VDC
		RS-485		K3GN-NDTI-FLK 24VDC
DC voltage/ current or PNP	2 relays (2 SPST-NO)	None		K3GN-PDC 24VDC
		RS-485		K3GN-PDC-FLK 24VDC
	3 PNP open collectors	None		K3GN-PDT2 24VDC
		RS-485		K3GN-PDT2-FLK 24VDC

1.3 I/O Circuits

Input Circuit Diagrams

Analog Input

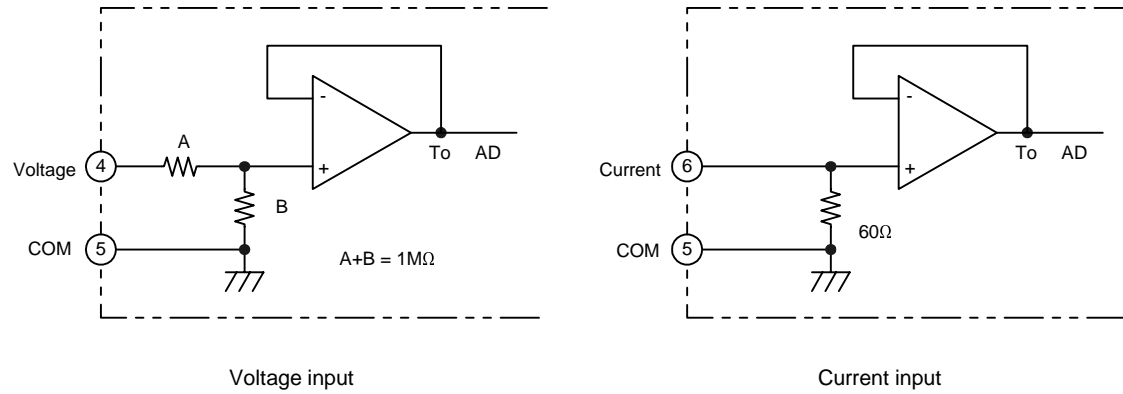

Event Input/Pulse Input

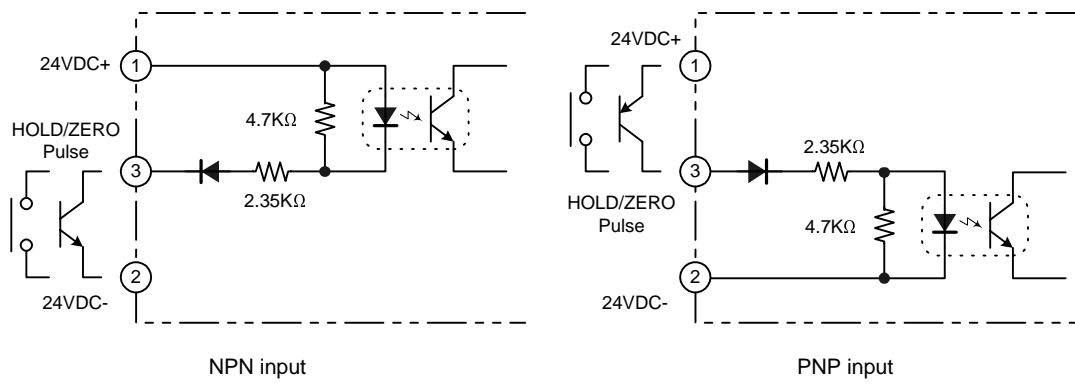

Output Circuit Diagrams

Contact Output

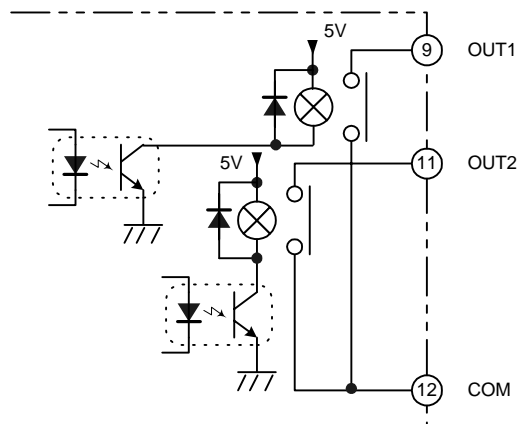

● Transistor Output

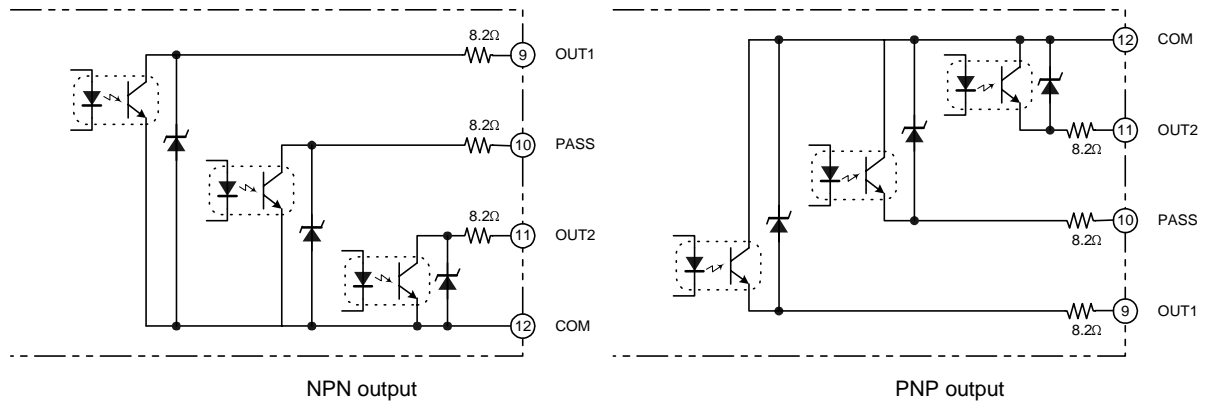

■ Internal Block Diagram

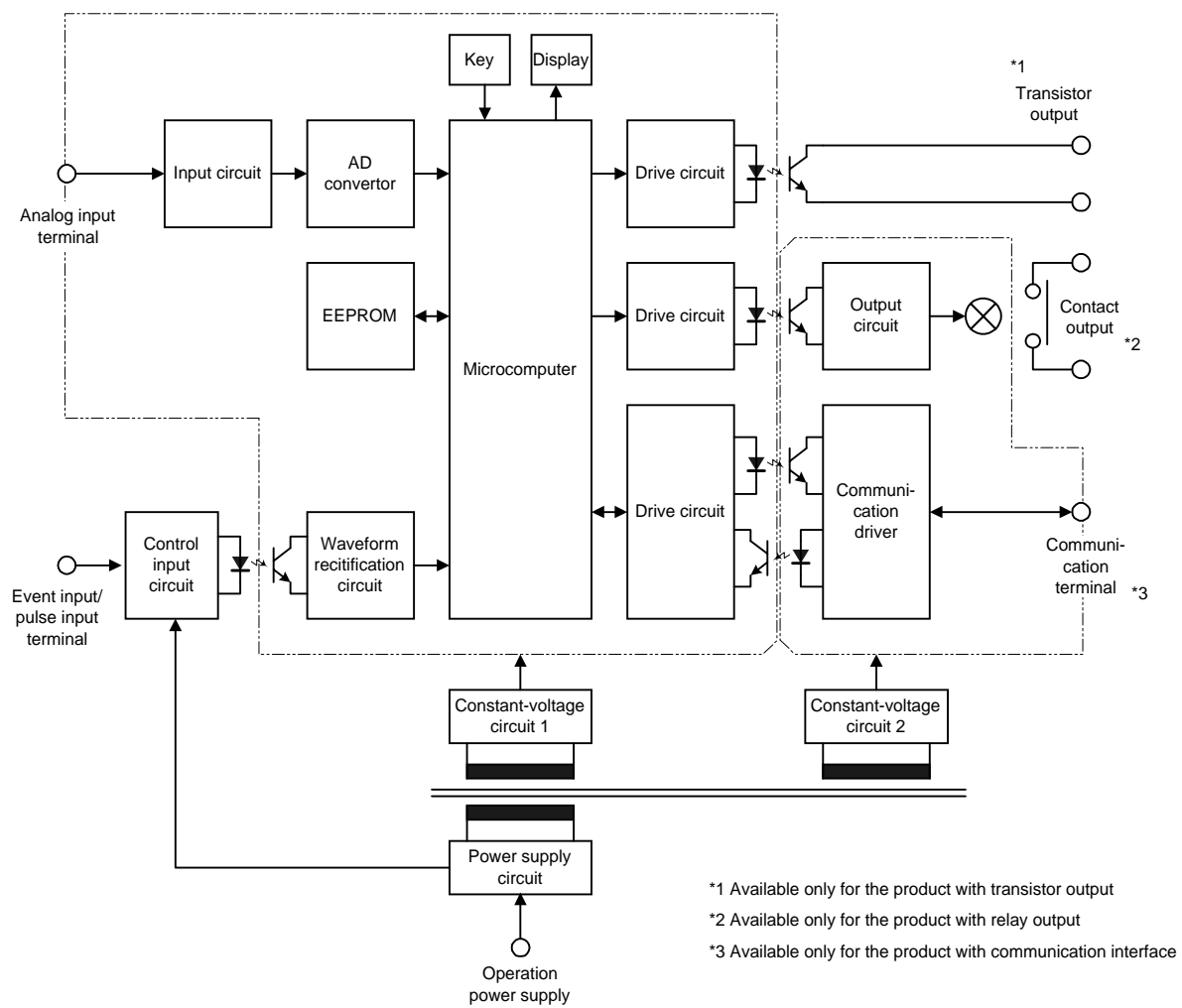

1.4 Parts Name and Function

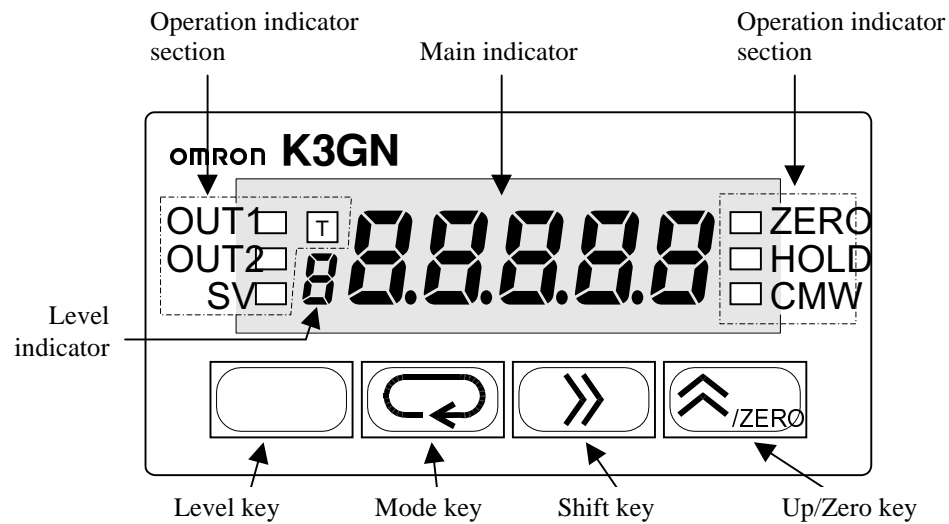

Name		Function
Main indicator		Displays a process value, parameter code, or set value.
Operation indicator sections	OUT1 (Comparative output 1)	Is on when comparative output 1 is ON, and off when comparative output 1 is OFF.
	OUT2 (Comparative output 2)	Is on when comparative output 2 is ON, and off when comparative output 2 is OFF.
	SV (Set value)	Stays on while a set value is displayed or being changed, and off at all other times.
	T (Teaching)	Stays on while a set value that can be taught is displayed, and blinks during teaching. At the calibration level, stays on while a calibration value is displayed, and blinks while the calibration value is read. Stays off at all other times.
	ZERO (Forced-zero)	Is on when zero-shifting by forced-zero operation is active. Turns off when forced-zero operation is canceled.
	HOLD (Process value hold)	Stays on while the process value is held, and off at all other times.
	CMW (Communication writing)	Is on while data reading and writing via communication interface are both enabled. Is off while data writing via communication interface is disabled. Data reading is enabled even if this indicator is off provided that the product has the communication function. If the product has no communication function, this indicator is always off.
Level indicator		Indicates the current level.
Level key		Use to change one level to another.
Mode key		Use to select a parameter.
Shift key		Use to check the set value of a parameter or enter the change state when the parameter is displayed. Use to select the digit that can be changed while shifting the set value.
Up/Zero key		Use to change the set value in the change state. Use to execute or cancel the forced-zero operation when a process value is displayed.

CHAPTER

2

**INSTALLATION
AND CONNECTION**

This chapter describes how to install and connect the product before turning the power on.

2.1	Installation	10
	Dimensions/Panel Cutout Dimensions/ Installation Procedure	
2.2	I/O Terminal Connections	12
	Terminal Arrangement/Terminal Connection	

2.1 Installation

■ Dimensions

Size of characters displayed
on the main indicator

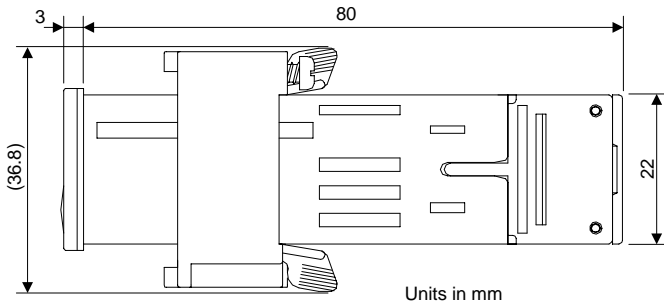
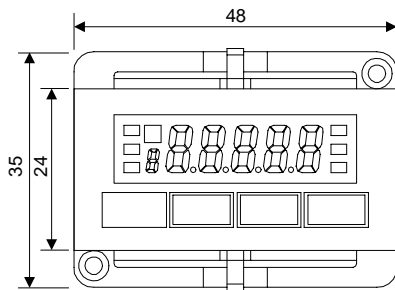
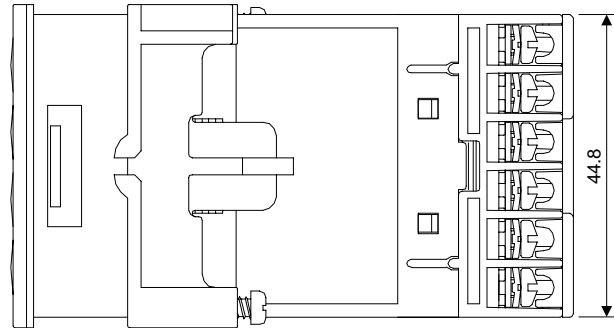
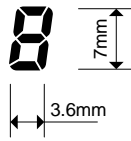

Units in mm

■ Panel Cutout Dimensions

Separate mounting (units in mm)

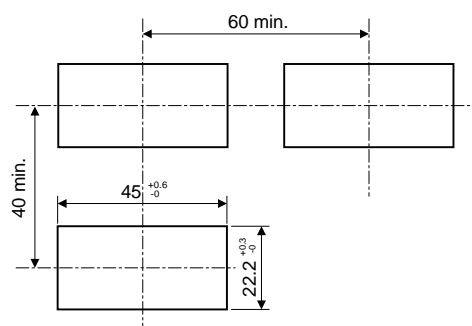

Gang mounting (units in mm)

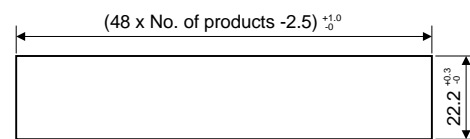

The products cannot be made waterproof when gang-mounted.

Fit the product into a rectangular panel cutout, put the adapter on the product from the rear end all the way to the panel, and tighten the screws of the adapter to secure the product.

When gang-mounting the products, make sure the ambient temperature of the product falls within the specified limits.

■ Installation Procedure

- (1) Fit the product into a rectangular panel cutout.
- (2) If you want to make the product waterproof, use the watertight packing as shown in the figure below.
Note that the watertight packing is direction-sensitive.

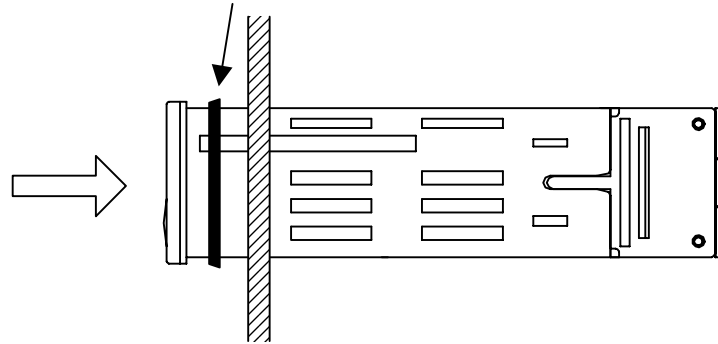

- (3) Put the adapter on the product from the rear end all the way to the panel.

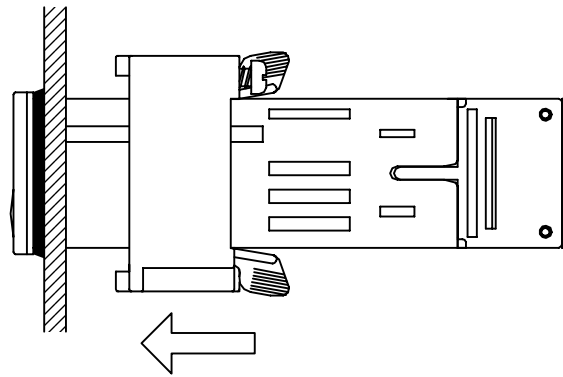

- (4) Tighten the two screws of the adapter in alternate order to a tightening torque of 0.29 to 0.39 N·m.

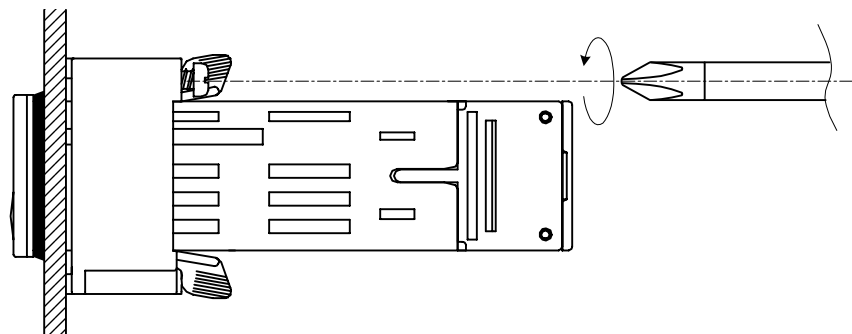

2.2 I/O Terminal Connections

Terminal Arrangement

INSTALLATION AND CONNECTION

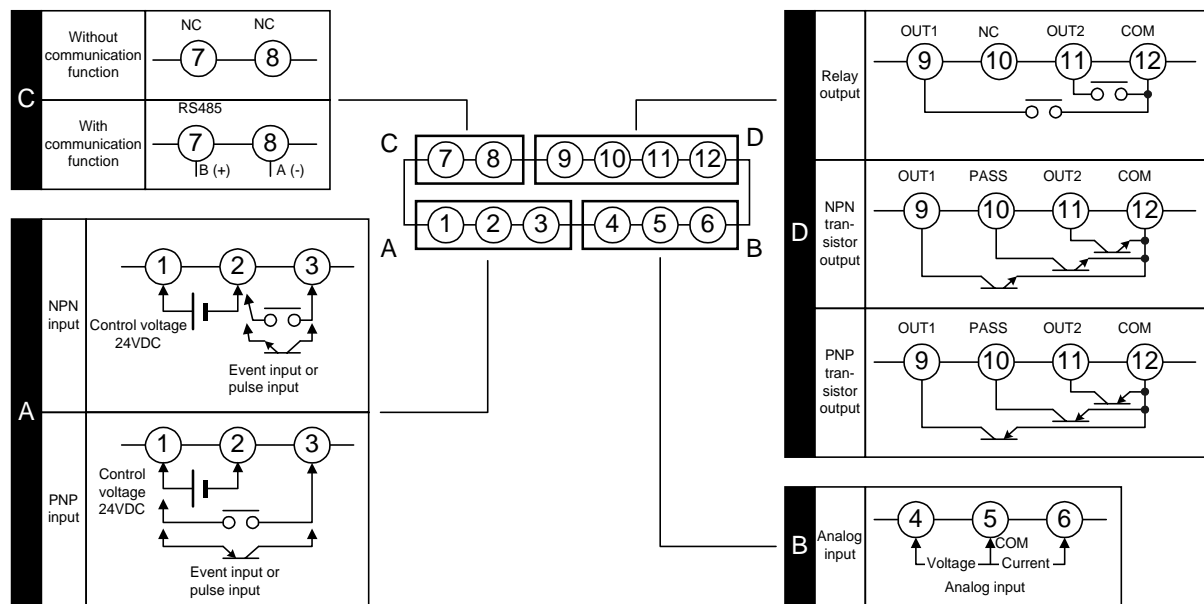

Terminal No.	Name	Description	Applicable model
①-②	Operation power supply	Operation power supply terminals	All models
③-②	Event input or pulse contact/ input	Depending on parameter setting: <ul style="list-style-type: none"> Hold the process value. Serve as input terminals for the forced-zero or forced-zero cancel operation. Serve as pulse input terminals when the input type is set to "pulse". 	K3GN-ND_-_24VDC
③-①			K3GN-PD_-_24VDC
④⑥-⑤	Analog input	Voltage/current analog terminals	All models
⑦-⑧	Communication	RS-485 communication terminals	K3GN-_D_-_FLK 24VDC
⑨⑪-⑫	Comparative output	Provide comparative output. Provide PASS output in addition to OUT1/OUT2 (comparative output 1/2) when the product is of transistor output type.	K3GN-_DC-_24VDC
⑨⑩⑪-⑫			K3GN-NDT1_-_24VDC K3GN-PDT2_-_24VDC

Terminal Connection

Wire the terminals using M3 crimp contacts of the type shown below.

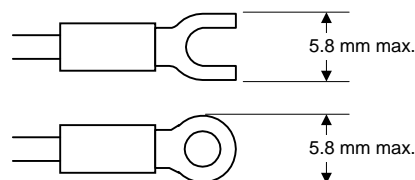

● **Power Supply**

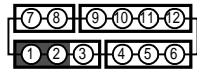

Connect the following power supply to terminals ① and ②.
 Supply voltage: 24VDC
 Operating voltage range: 85 to 110% of the rated voltage
 Power consumption: 2.5W (at max. load)

Note that, when turned on, the product will require the operation power supply to have more power supply capacity than rated.
 If multiple products are used, the power supply must be able to afford to supply power to the products.

● **Event Input or Pulse Input**

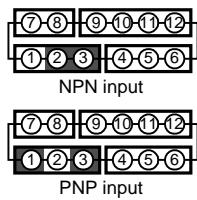

Apply the event or pulse signal to terminals ③ and ② if the product is of NPN input type, or terminals ③ and ① if the product is of PNP input type.

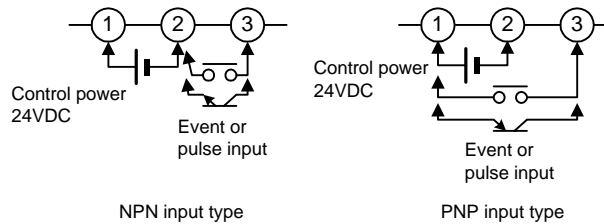

The input equipment connected to these terminals must meet the following conditions.

Transistor output	ON residual current:	2.5V max.
	OFF leakage current:	0.1 mA max.
	Current leakage with transistor turned ON:	15 mA min.
Relay output	Load current:	5 mA max.

● **Analog Input**

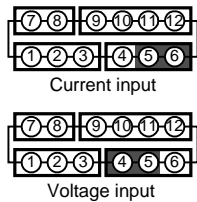

The following table shows the analog ranges and applicable analog input terminals.

Analog range	Positive side	Negative side
4 to 20 mA/0 to 20 mA	⑥	⑤
1 to 5V/0 to 5V	④	⑤
±5V	④	⑤
±10V	④	⑤

The maximum absolute ratings for analog input are as follows.
 Be careful that these ratings must not be exceeded even for a moment.
 4 to 20 mA/0 to 20 mA: ±30 mA
 1 to 5V/0 to 5V: ±13.5V
 ±5V: ±13.5V
 ±10V: ±26V

● **Communication**

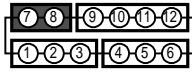

Connect the communication cable to terminals ⑦ and ⑧ if using the communication function.

RS-485 connections can be one-to-one or one-to N. A maximum of 32 units (including the host computer) can be connected in one-to-N systems.

The total length of the communication cables should be up to 500 m.

Use shielded twisted-pair cables (AWG 28 or thicker) as the communication cables.

Be sure to turn ON the terminator switches only in the devices at each end of the transmission line.

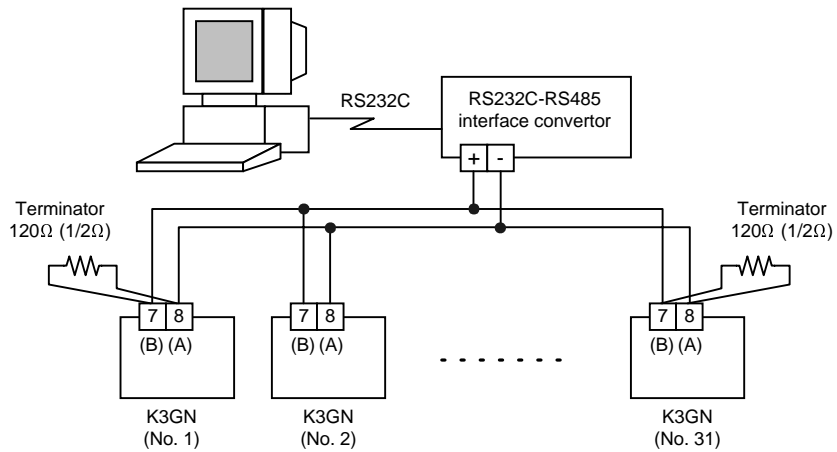

Match the communications format of the K3GN and the host computer. If a one-to-N system is being used, be sure that the communications formats of all devices in the system (except individual unit numbers) are the same.

Chapter 7 explains how to set the K3GN communication format. Refer to your computer's manual for details on changing its communications settings.

● **Comparative Output**

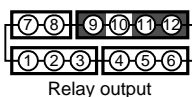
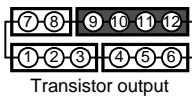

Comparative output is produced at terminals ⑨ to ⑫.

If the product is of relay output type, terminal ⑩ is not used.

Loads connected to the product and the power supply for the loads must be rated as follows.

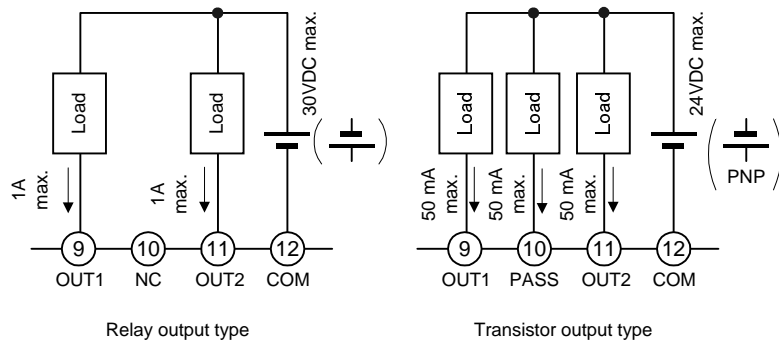

The $\left(\begin{array}{c} \text{---} \\ | \\ \text{---} \end{array}\right)$ connection causes the current to flow in the direction opposite to indicated by the arrows.







CHAPTER

**3 APPLICATION
EXAMPLES**

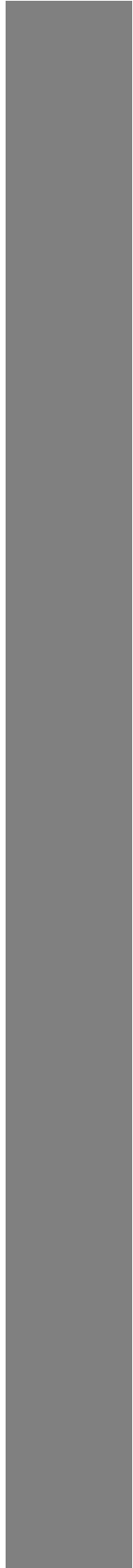
This chapter shows some examples of product applications.

- 
- 
- 3.1 Monitoring the Remaining Quantity of Soup.....16
 - 3.2 Monitoring the Load Current of a Motor18
 - 3.3 Monitoring the Quantity of Dust20
 - 3.4 Monitoring the Internal Pressure of a Tank22
 - 3.5 Monitoring the Rotational Speed of a Motor24
 - 3.6 Using the Product as a Digital Indicator for PLC26

3.1 Monitoring the Remaining Quantity of Soup

Application

APPLICATION EXAMPLES

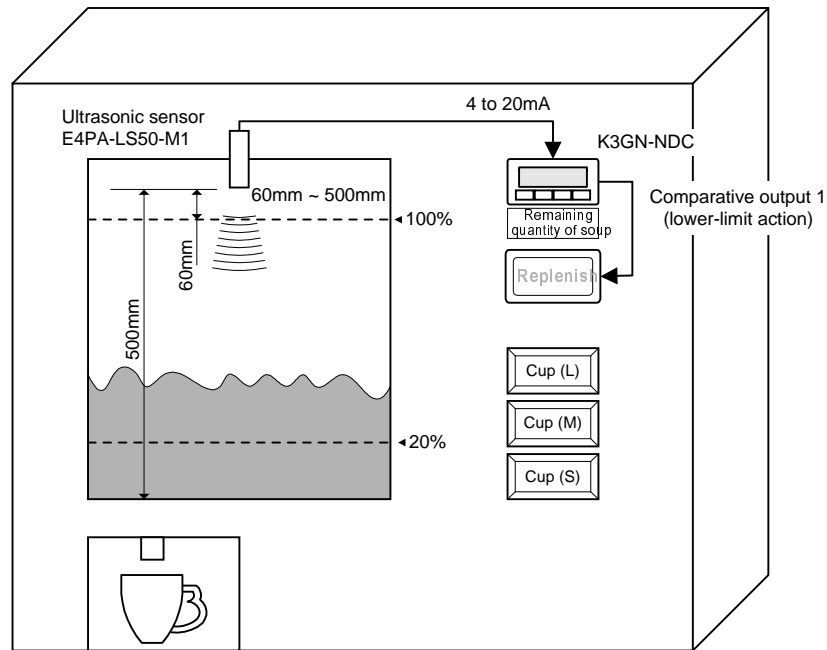

- The remaining quantity of soup is monitored.
- The soup level is measured with an ultrasonic displacement sensor.
- The K3GN indicates the remaining quantity of soup on a percentage basis.
- Four measurements are averaged for stable indication.
- Comparative output 1 is produced as a lower-limit action signal. When the remaining quantity of soup reaches 20% (lower limit), the “Replenish” indicator turns on.

Wiring

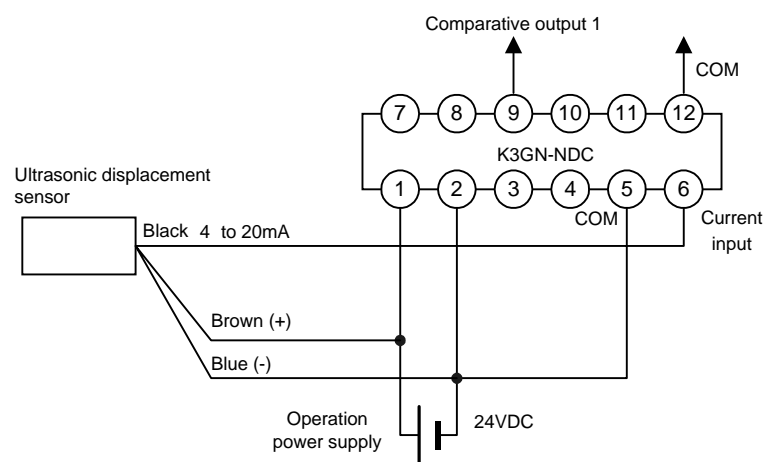

Parameter Setting

Set the parameters of the K3GN as follows.

Level	Parameter	Set value
Initial setting	Unit	ANALG
	range	4-20
	inp.1	400
	dSP.1	100
	inp.2	2000
	dSP.2	0
	dP	00000
Advanced-function setting	ALG	4
Operation setting	OUT 1	20

Set the analog output characteristic mode of the sensor to “decrease”. For details on sensor setting, refer to the Operation Manual for the sensor.

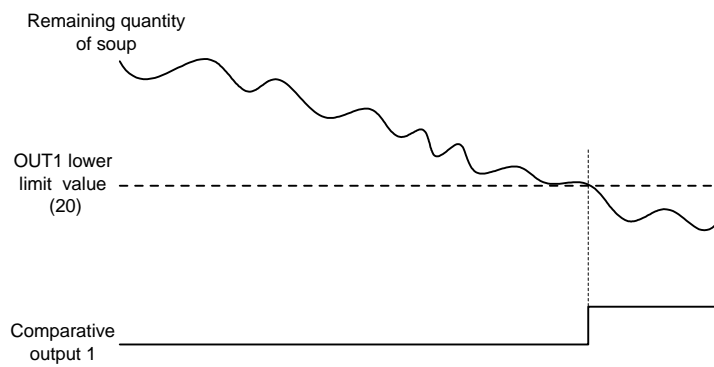
Operation

- Comparative output 1 turns on when the remaining quantity of soup decreases to 20%.

3.2 Monitoring the Load Current of a Motor

Application

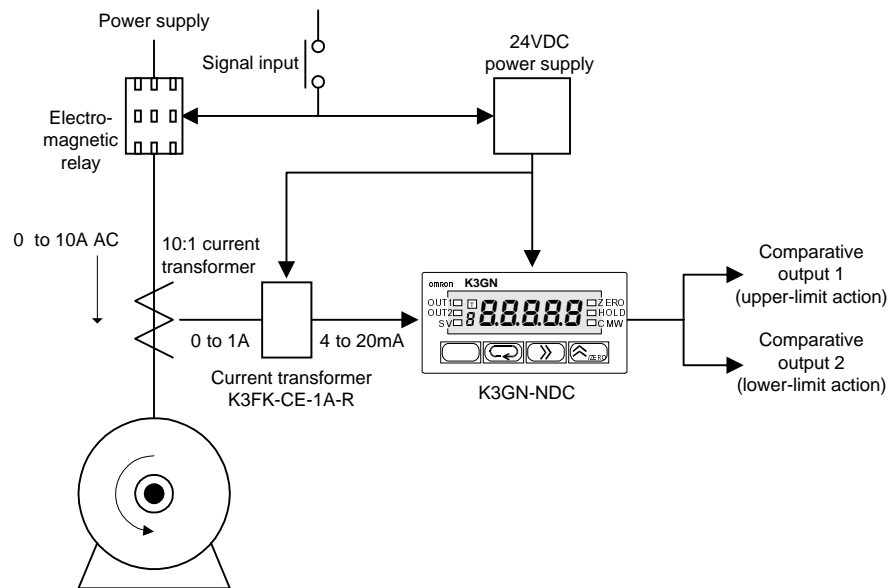

- The load current of a motor is monitored.
- A 10:1 current transformer is used to detect the motor current.
- The current transformer K3FK-CE-1A-R is used to adapt the input current to a K3GN analog range.
- The K3GN indicates the load current in units of amperage to two decimal places.
- Comparative output 1 is used to generate an upper-limit action signal and comparative output 2 is used to generate a lower-limit action signal.
- The OUT upper-limit value is set to 6.00A and the OUT lower-limit value is set to 3.00A.

Wiring

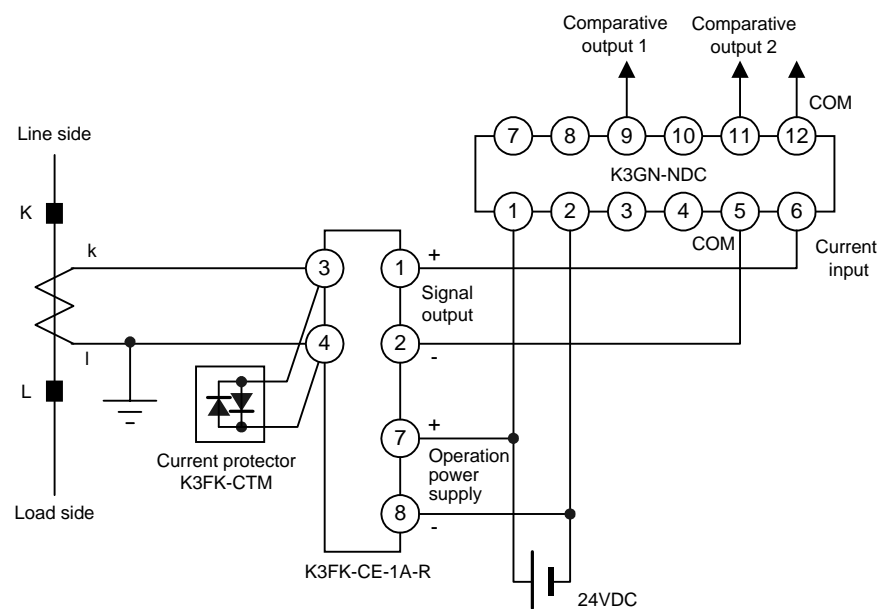

Parameter Setting

Set the parameters of the K3GN as follows.

Level	Parameter	Set value
Initial setting	Unit	ARRLG
	rANGE	4-20
	Unit 1	4.00
	dSP.1	0
	Unit 2	20.00
	dSP.2	10.00
	dP	0000.00
	Unit 1k	HZ
Operation setting	Unit 1	6.00
	Unit 2	3.00

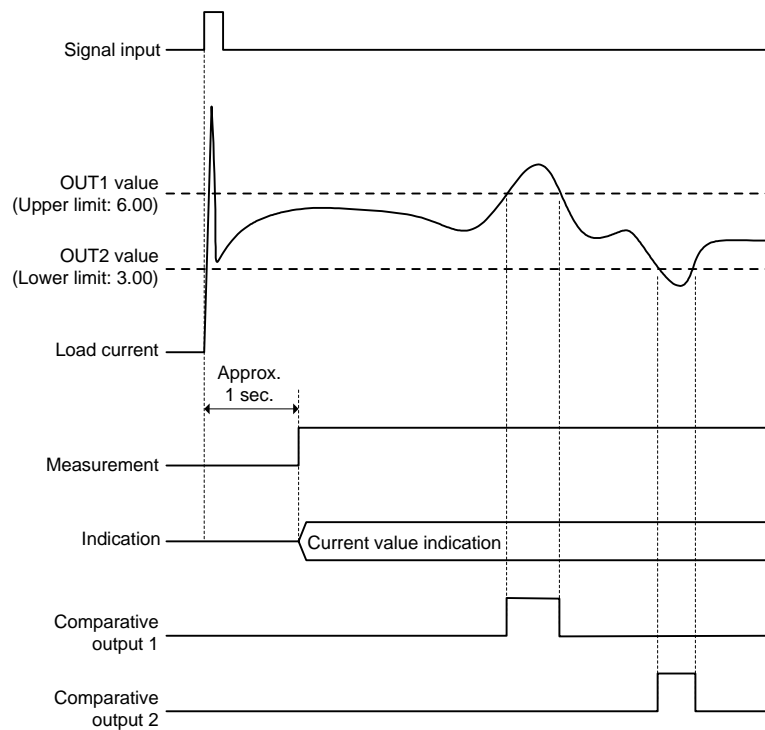
For details on the parameters, refer to **CHAPTER 5 OPERATION**.**Operation**

- Turning the power on causes inrush current to flow through the motor. But the K3GN does not produce superfluous output in response to the inrush current because it does not perform measuring operation for approx. one second after turn-on.
- Comparative output 1 turns on when the current flowing through the motor reaches 6.00A.
Comparative output 2 turns on when the current flowing through the motor decreases to 3.00A.

3.3 Monitoring the Quantity of Dust

Application

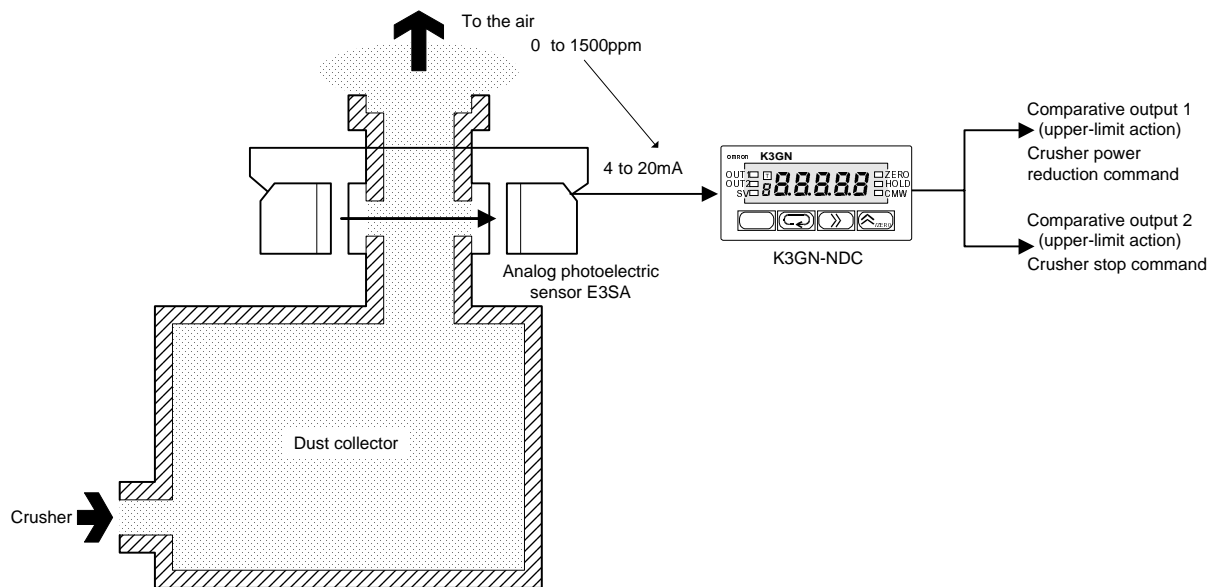

APPLICATION
EXAMPLES

- The quantity of dust exhausted from a dust collector into the air is monitored.
- The analog photoelectric sensor E3SA is used to detect the quantity of dust.
- A dust quantity of 0 to 1500 ppm corresponds to an E3SA output of 4 to 20 mA.
- The K3GN indicates the quantity of dust in units of ppm.
- Comparative output 1 is used to generate an upper-limit action signal that reduces the crusher power.
- Comparative output 2 is used to generate another upper-limit action signal that stops the crusher.
- The OUT 1 upper-limit value is 800 ppm and the OUT2 upper-limit value is 1000 ppm.
- Eight measurements are averaged for stable indication.
- The hysteresis is set to 10 for stable output in the vicinity of the OUT set values.

Wiring

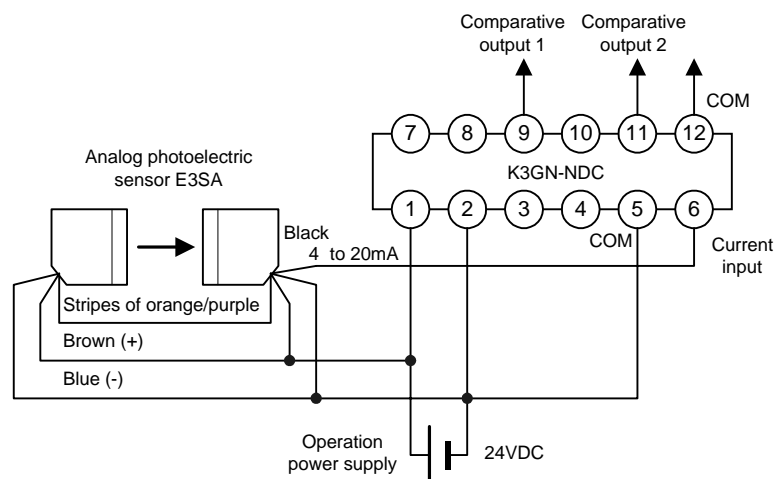

Parameter Setting

Set the parameters of the K3GN as follows.

Level	Parameter	Set value
Initial setting	Unit	PPM
	range	4-20
	Unit 1	400
	dSP.1	0
	Unit 2	20.00
	dSP.2	1500
	dP	00000
	OUT1t	HZ
	OUT2t	HZ
Advanced-function setting	ALG	8
	HYS1	10
	HYS2	10
Operation setting	OUT1	800
	OUT2	1000

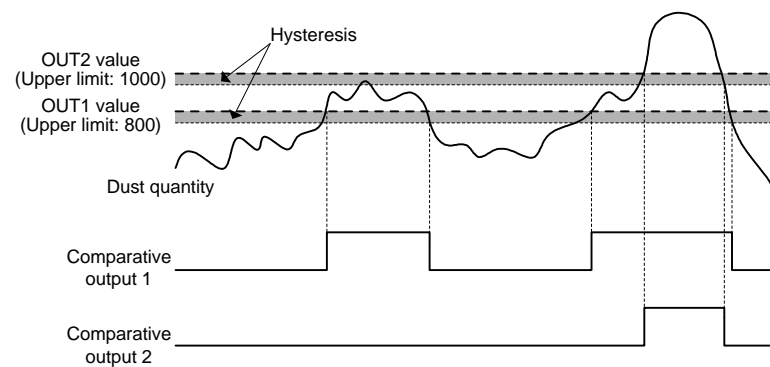
For details on the parameters, refer to **CHAPTER 5 OPERATION**.**Operation**

- Comparative output 1 turns on when the dust quantity reaches 800 ppm.
- When comparative output 1 turns on, the crusher power is reduced until the dust quantity decreases to within the specified range.
- Comparative output 2 turns on when an accident causes a sudden increase in dust quantity to 1000 ppm.
- When comparative output 2 turns on, it provides an emergency stop to the crusher.

3.4 Monitoring the Internal Pressure of a Tank

Application

APPLICATION EXAMPLES

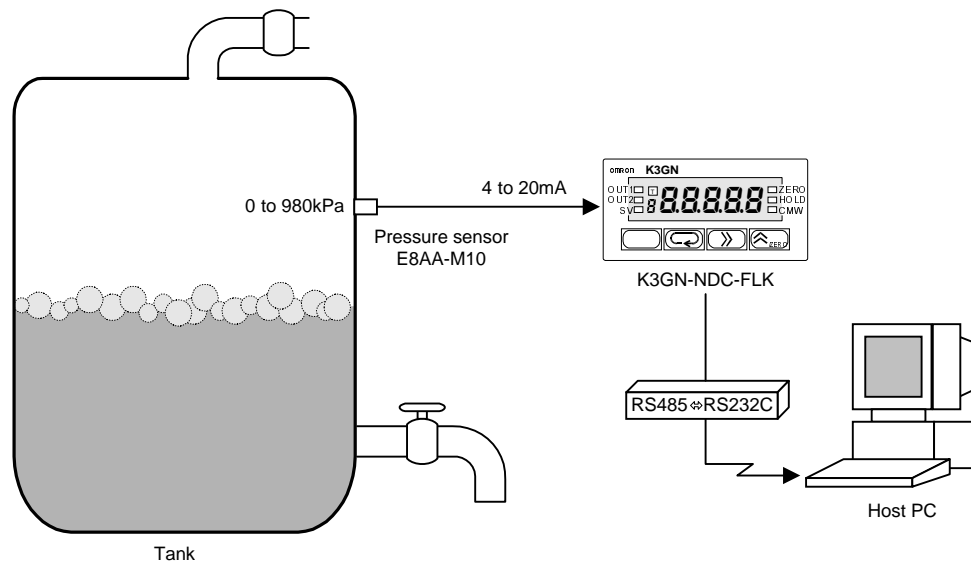

- The internal pressure of a tank is monitored.
- The pressure sensor E8AA-M10 is used to detect the pressure in the tank.
- A pressure of 0 to 980 kPa corresponds to an E8AA-M10 output of 4 to 20 mA.
- The K3GN indicates the pressure in units of kPa to one decimal place.
- The communication function of the K3GN enables remote monitoring of the pressure on the host PC.
- The status of comparative outputs is read by the host PC at a remote site.
- Comparative output 1 turns on when the pressure reaches 550.0 kPa, which generates an upper-limit action signal.
- Comparative output 2 turns on when the pressure decreases to 100.0 kPa, which generates a lower-limit action signal.

Wiring

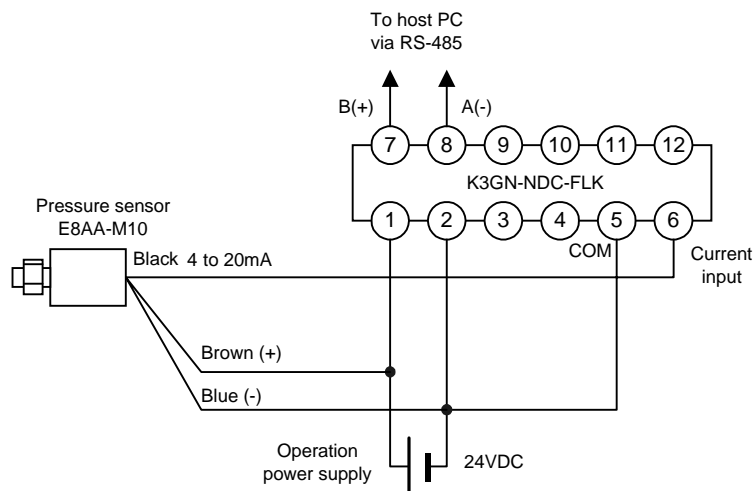

Parameter Setting

Set the parameters of the K3GN as follows.

Level	Parameter	Set value
Initial setting	Unit	PaRLG
	rANGE	4-20
	LnP.1	4.00
	dSP.1	0
	LnP.2	20.00
	dSP.2	9800
	dP	0000.0
	OUT 1t	Kc
Communication setting	U-no	1
	bPS	9.6
	LEn	7
	SbIt	2
Operation setting	PrtY	EwEn
	OUT 1	550.0
	OUT 2	100.0

Set the communication parameters according to the host PC setting.

For details on the parameters, refer to **CHAPTER 5 OPERATION**.

Operation

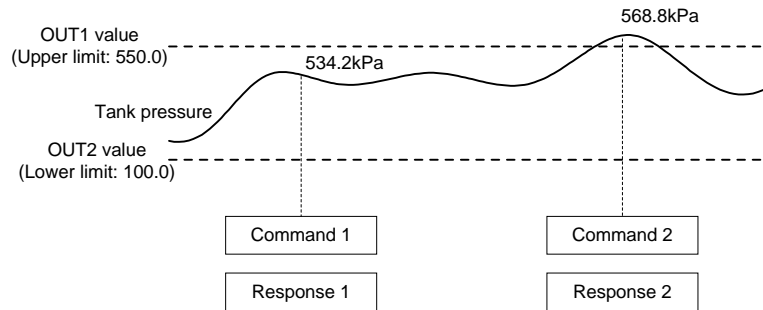

	MRC	SRC	Variable type	Address	Bit position	No. of elements
Command 1	"01"	"01"	"C0"	"0001"	"00"	"0002"
Response 1	"01"	"01"	Response code	Current value		Status
	"01"	"01"	"0000"	"000014DE"		"00000400"
			14DEH (5342 in decimal)		(PASS output ON)	
	MRC	SRC	Variable type	Address	Bit position	No. of elements
Command 2	"01"	"01"	"C0"	"0001"	"00"	"0002"
Response 2	"01"	"01"	Response code	Current value		Status
	"01"	"01"	"0000"	"00001638"		"00000100"
			1638H (5688 in decimal)		(Comparative output 1 ON)	

- The host PC reads the current value and the status from the K3GN at regular intervals.

Of command and response frames, only text fields are shown in the above figure. For details on communications, refer to **CHAPTER 7 COMMUNICATIONS**.

3.5 Monitoring the Rotational Speed of a Motor

APPLICATION EXAMPLES

Application

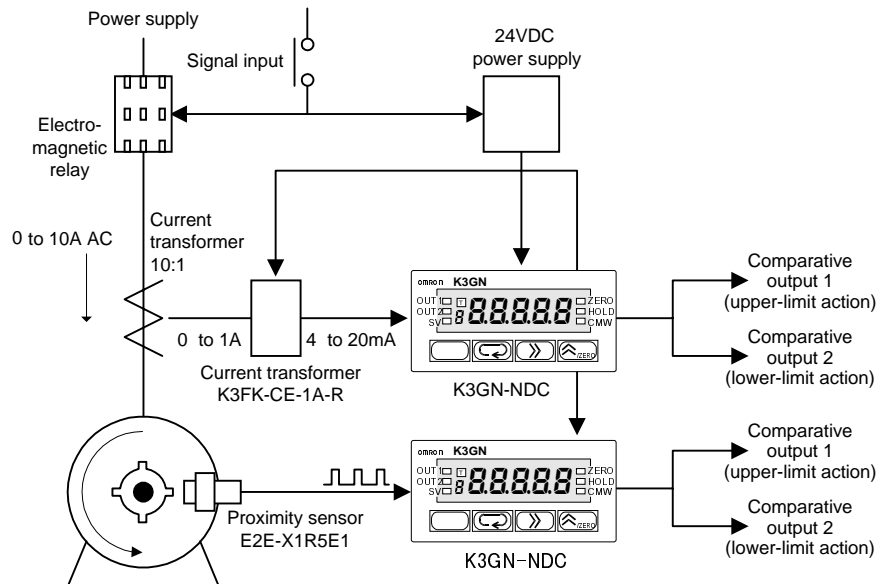

- In addition to the load current monitored in the application shown in Section 3.2, the rotational speed of a motor is also monitored with an additional K3GN.
- A four-toothed wheel is installed on the motor shaft to allow detection of its rotational speed.
- The proximity sensor E2E-X1R5E1 converts motor shaft rotations to on/off pulses.
- The K3GN indicates the rotational speed in terms of rpm.
- A startup compensation timer is used to prevent superfluous output from being produced until the motor reaches a designated speed (for five seconds after startup).
- Comparative output 1 is used to generate an upper-limit action signal. Comparative output 2 is used to generate a lower-limit action signal.
- The OUT1 upper-limit value is set to 3500 rpm and the OUT2 lower-limit value to 1000 rpm.
- The auto-zero function is used to enhance the lower-limit response. (A speed of 150 rpm or less is automatically shifted to zero).

Wiring

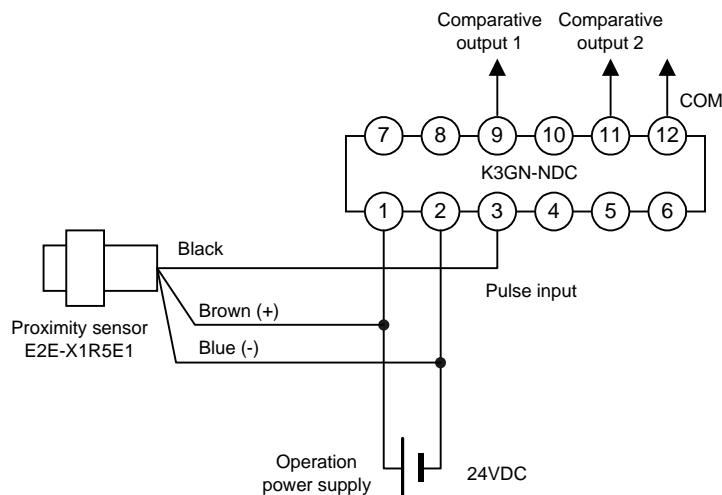

Parameter Setting

Set the parameters of the K3GN as follows.

Level	Parameter	Set value
Initial setting	Unit	PULSE
	P-FrE	5%
	LnP	1000
	dSP	15000
	dP	00000
	OUT 1t	HZ
Advanced-function setting	OUT 2t	L0
	Auto. E	0.1
Operation setting	StAr	5.0
	OUT 1	3500
	OUT 2	1000

For details on the parameters, refer to **CHAPTER 5 OPERATION**.

APPLICATION
EXAMPLES

Operation

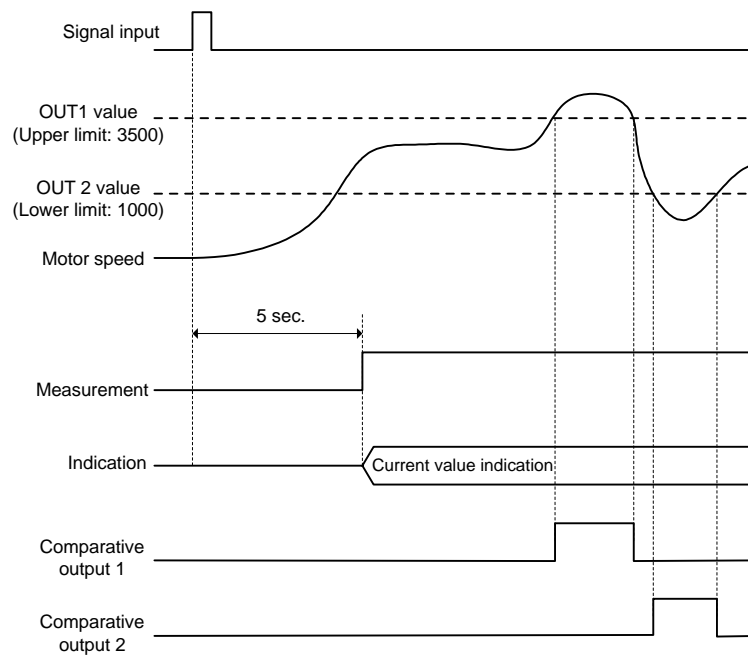

- The startup compensation timer works for five seconds after the motor power is turned on. This prevents superfluous output from being produced by the K3GN.
- Comparative output 1 turns on when the motor speed reaches 3500 rpm. Comparative output 2 turns on when the motor speed decreases to 1000 rpm.

3.6 Using the Product as a Digital Indicator for PLC

Application

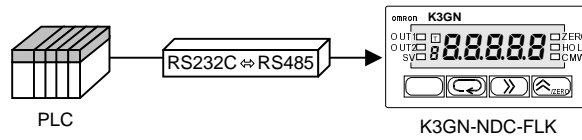

- The K3GN is used as a digital indicator for PLC data.
- The display color of the K3GN main indicator is set to “always green”.
- The process value is displayed without scaling.

Wiring

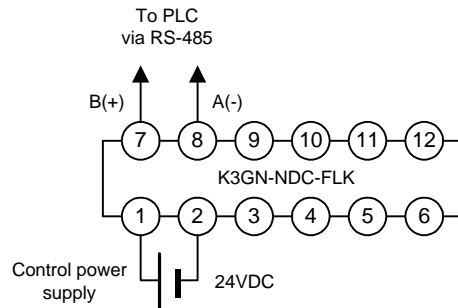

Parameter Setting

Set the parameters of the K3GN as follows.

Level	Parameter	Set value
Initial setting	Unit	unit
	LnP.1	19999
	dSP.1	19999
	LnP.1	99999
	dSP.1	99999
	dP	00000
Communication setting	Unit	1
	bPS	96
	LEN	7
	Stk	2
	Prty	EuEn
Advanced-function setting	Color	Grn

Set the communication parameters according to the host PC setting
For details on the parameters, refer to **CHAPTER 5 OPERATION**.

Operation

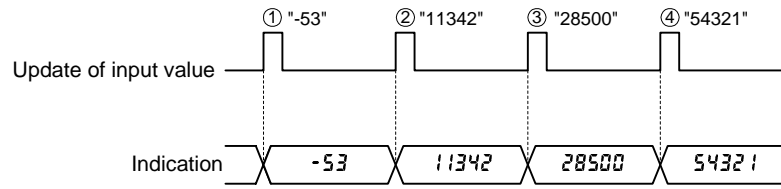

	MRC	SRC	Variable type	Address	Bit position	No. of elements	Current value
Command①	"01"	"02"	"C2"	"0000"	"00"	"0001"	"FFFFFFCB" FFFFFFCBH (-53 in decimal)
Command②	"01"	"02"	"C2"	"0000"	"00"	"0001"	"00002C4E" 2C4EH (11342 in decimal)
Command③	"01"	"02"	"C2"	"0000"	"00"	"0001"	"00006F54" 6F54H (28500 in decimal)
Command④	"01"	"02"	"C2"	"0000"	"00"	"0001"	"0000D431" D431H (54321 in decimal)

APPLICATION
EXAMPLES





CHAPTER

4 INITIAL SETTING

Typical applications of the product include a process meter, a tachometer, or an indicator of digital data from PLC/PC.

This chapter explains the flow of initial setting for each of these applications.

- 
- | | | |
|-----|--|----|
| 4.1 | Using the Product as a process meter | 30 |
| 4.2 | Using the Product as a Tachometer | 32 |
| 4.3 | Using the Product as a Digital Indicator | 34 |

4.1 Using the Product as a process meter

The following example shows the flow of initial setting for the product that is used as a process meter.

Setting example:

Input signals ranging from 1 to 5V is scaled to readouts ranging from 0 to 100 kg.

Comparative output 1 is produced when the process value (readout) reaches 70.0 kg.

Comparative output 2 is produced when the process value (readout) decreases to 50.0 kg.

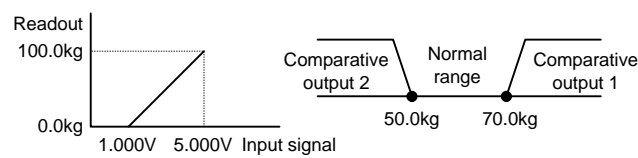

Flow of Initial Setting

A. Check wiring for correct connection and power the product on.

The product is factory set to have an analog input range of 4 to 20 mA. If an input that falls outside this default range is received, the main indicator of the product will read “5.Err” and blink, indicating an “input range over” error occurs.

B. Set “input type” to “analog”.

1. Make sure the main indicator displays a process value (the product is at the operation level).
Then press the key and hold it down for at least one second.
The product will move to the initial setting level.
2. Set parameter “*Input*” to “*ANALOG*”.

C. Set “analog range” to “1 ~ 5V”.

1. Set parameter “*Range*” to “*1-5*”.

D. Specify the scaling factor.

1. Set parameter “*Scale 1*” to “*1.000*”.
2. Set parameter “*Disp 1*” to “*0*”.
3. Set parameter “*Scale 2*” to “*5.000*”.
4. Set parameter “*Disp 2*” to “*1000*”.

E. Specify the decimal point position.

1. Set parameter “*DP*” to “*0000.0*”.

Note

The input type, analog range, scaling factor, and decimal point position should be set in this order.

Otherwise, auto-initialization of parameters may result in a failure in parameter setting. If you specify the scaling factor and then the input type, for example, the analog range and the scaling factor are initialized automatically.

F. Set “OUT1 value type” to “upper limit” and “OUT2 value type” to “lower limit”.

1. Set parameter “OUT1” to “HL”.
2. Set parameter “OUT2” to “Ll”.

G. Set the OUT1 value to “70.0” and the OUT2 value to “50.0”.

1. Make sure the main indicator displays an initial setting level parameter (the product is at the initial setting level).
Then press the key and hold it down for at least one second.
The product will move to the operation level.
2. Set parameter “OUT1” to “70.0”.
3. Set parameter “OUT2” to “50.0”.

TIPS

The number of measurements for averaging and the hysteresis can be changed if required. These parameters are to be set at the advanced-function setting level.

H. Bring the product into measuring operation.

Clear All

If you are confused about how parameters have been set during initial setting, you can clear all the parameters and start all over again.

For details on how to clear all parameters, refer to **Section 5.16 Clearing All Parameters**.

For details on parameter setting, refer to **CHAPTER 5 OPERATION**.

INITIAL
SETTING

4.2 Using the Product as a Tachometer

The following example shows the flow of initial setting for the product that is used as a tachometer.

Setting example:

The speed of a conveyor belt is indicated in terms of m/min.
 Four pulses are generated per rotation of the rotor.
 The diameter of the rotor is 12 cm.
 Comparative output 1 is produced when the speed reaches 10500 m/min.
 Comparative output 2 is produced when the speed decreases to 9500 m/min.

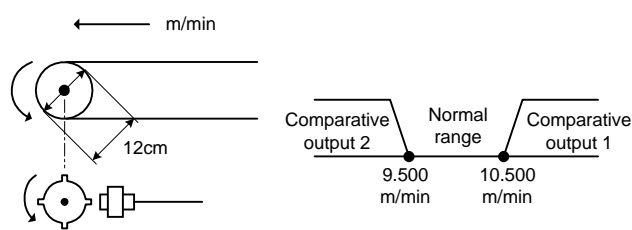

How to Determine the Scaling Factor

Determine the scaling factor as follows.

$$\begin{aligned} \text{Rotor rotational speed (rpm)} \\ &= \text{Input frequency (Hz)} / \text{Number of pulses per rotation} \times 60 \end{aligned}$$

$$\begin{aligned} \text{Belt Speed (m/min)} \\ &= \pi \times \text{Rotor diameter (m)} \times \text{Rotor rotational speed (rpm)} \end{aligned}$$

Hence the belt speed is given as

$$\begin{aligned} \text{Belt speed (m/min)} &= 3.14159... \times 0.12 \times 60/4 \times \text{Input frequency (Hz)} \\ &= 5.654866... \times \text{Input frequency (Hz)} \end{aligned}$$

Multiply the result by 1000 to enable a readout to be displayed to three decimal places.

$$\text{Belt speed (m/min)} = 5654.866... \times \text{Input frequency (Hz)}$$

To minimize the scaling operation error, select such an input frequency that allows readouts to contain the largest possible number of digits. In this example, the input frequency is set to 10 Hz so that the readout is 56549.

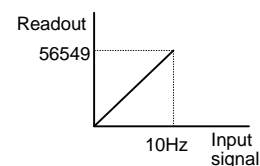

Flow of Initial Setting

- A.** Check wiring for correct connection and power the product on.

The product is factory set to have an analog input range of 4 to 20 mA. If an input that falls outside this default range is received, the main indicator of the product will read "5Err" and blink, indicating an "input range over" error occurs.

Note

The input type, pulse frequency, scaling factor, and decimal point position should be set in this order. Otherwise, auto-initialization of parameters may result in a failure in parameter setting. If you specify the scaling factor and then the input type, for example, the pulse frequency and the scaling factor are initialized automatically.

B. Set “input type” to “pulse”.

1. Make sure the main indicator displays a process value (the product is at the operation level).
Then press the key and hold it down for at least one second.
The product will move to the initial setting level.
2. Set parameter “*Input*” to “*PULSE*”.

C. Set “pulse frequency” to “30 Hz”.

1. Set initial setting level parameter “*P-FRE*” to “*30*”.
This is because this application is expected to involve an input frequency of approx. 2 Hz and not more than 30 Hz.

D. Specify the scaling factor.

1. Set parameter “*Scale*” to “*10.00*”.
2. Set parameter “*dSP*” to “*56549*”.

E. Specify the decimal point position.

1. Set parameter “*dP*” to “*00.000*”.

F. Set “OUT1 value type” to “upper limit” and “OUT2 value type” to “lower limit”.

1. Set parameter “*OUT1*” to “*HL*”.
2. Set parameter “*OUT2*” to “*LO*”.

G. Set the OUT1 value to “10.500” and the OUT2 value to “9.500”.

1. Make sure the main indicator displays an initial setting level parameter (the product is at the initial setting level).
Then press the key and hold it down for at least one second.
The product will move to the operation level.
2. Set parameter “*OUT1*” to “*10.500*”.
3. Set parameter “*OUT2*” to “*9.500*”.

H. Bring the product into measuring operation.**Clear All**

If you are confused about how parameters have been set during initial setting, you can clear all the parameters and start all over again.

For details on how to clear all parameters, refer to **Section 5.16 Clearing All Parameters**.

TIPS

The number of measurements for averaging and the hysteresis can be changed if required.
These parameters are to be set at the advanced-function setting level.

INITIAL
SETTING

For details on parameter setting, refer to **CHAPTER 5 OPERATION**.

4.3 Using the Product as a Digital Indicator for PLC Data

The following example shows the flow of initial setting for the product that is used as a digital indicator for PLC data.

Setting example:

Full span 0H to 0FA0H (0 to 4000 in decimal) of a PLC analog input unit is scaled to 80.0 to 120.0 mm and displayed.

Comparative output 1 is produced when the process value reaches 110.0 mm. Comparative output 2 is produced when the process value decreases to 90.0 mm.

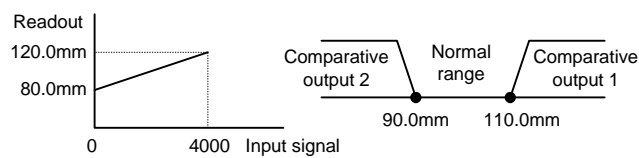

Flow of Initial Setting

A. Check wiring for correct connection and power the product on.

The product is factory set to have an analog input range of 4 to 20 mA. If an input that falls outside this default range is received, the main indicator of the product will read “*S.E.R.R*” and blink, indicating an “input range over” error..

B. Set “input type” to “remote”.

1. Make sure the main indicator displays a process value (the product is at the operation level). Then press the key and hold it down for at least one second. The product will move to the initial setting level.
2. Set parameter “*ĩ n - t*” to “*r ñ t*”.

C. Specify the scaling factor.

1. Set parameter “*ĩ n P . 1*” to “*0*”.
2. Set parameter “*d S P . 1*” to “*800*”.
3. Set parameter “*ĩ n P . 2*” to “*4000*”.
4. Set parameter “*d S P . 2*” to “*1200*”.

D. Specify the decimal point position.

1. Set parameter “*d P*” to “*0000.0*”.

E. Set “OUT1 value type” to “upper limit” and “OUT2 value type” to “lower limit”.

1. Set parameter “*õ U t 1 . t*” to “*H ĩ*”.
2. Set parameter “*õ U t 2 . t*” to “*L ã*”.

TIPS

Setting “input type” to “remote” sets the adjustment level parameter “downloading (communication writing)” to “enable” automatically. The “CMW” indicator on the front panel will be illuminated.

Note

The input type, scaling factor, and decimal point position should be set in this order. Otherwise, auto-initialization of parameters may result in a failure in parameter setting. If you specify the scaling factor and then the input type, for example, the scaling factor is initialized automatically.

F. Specify communication parameters.

1. Make sure the main indicator displays an initial setting level parameter. Then press the key. The product will move to the communication setting level.
2. Set parameter “*U-ID*” as appropriate. Exercise care to avoid assigning the same ID number to more than one K3GN when connecting multiple products to one host PC.
3. Set parameter “*BP5*” to the same value as in the host PC.
4. Set parameter “*LEN*” to the same value as in the host PC.
5. Set parameter “*SBCT*” to the same value as in the host PC.
6. Set parameter “*PRTY*” to the same value as in the host PC.

G. Set the OUT1 value to “110.0” and the OUT2 value to “90.0”.

1. Make sure the main indicator displays an initial setting level parameter. Then press the key and hold it down for at least one second. The product will move to the operation level.
2. Set parameter “*OUT1*” to “110.0”.
3. Set parameter “*OUT2*” to “90.0”.

TIPS

The number of measurements for averaging and the hysteresis can be changed if required. These parameters are to be set at the advanced-function setting level.

H. Bring the product into measuring operation.**Clear All**

If you are confused about how parameters have been set during initial setting, you can clear all the parameters and start all over again. For details on how to clear all parameters, refer to **Section 5.16 Clearing All Parameters**.

INITIAL
SETTING

For details on parameter setting, refer to **CHAPTER 5 OPERATION**.

5.1 Levels

In this manual, setting items of the product are grouped into seven levels as follows.

Level	Description	Measurement
Protect	This level allows parameter setting for protection against unauthorized or inadvertent key operation. Access to protected levels or setting items is disabled.	Yes
Operation	This level represents the normal operation state in which the product can accept input signals and provide comparative outputs. Not only readout of the current process value but also access to or changes of OUT set values are allowed at this level. The product enters this level at power-on.	Yes
Adjustment	This level permits communication writing to be enabled or disabled. Even if communication writing is disabled, reading is always enabled. If your product has no communication function, this level is not available.	Yes
Initial setting	This level allows initial setting of the input type, analog range, scaling factor and the like. Available only for the product with communication function.	No
Communication setting	This level allows setting of the baud rate, word length and other communication parameters. Available only for the product with communication function	No
Advanced-function setting	This level allows setting of the number of measurements for averaging. Customizations such as a change in display color are also possible at this level.	No
Calibration	This level allows user calibration. Note that user calibration could cause deterioration in measuring accuracy of the product.	No

OPERATION

During operation of the product, the level indicator designates the current level. Alphabetic characters shown on the level indicator and their corresponding levels are shown below.



Alphabetic character	Level
<i>P</i>	Protect level
(OFF)	Operation level
<i>A</i>	Adjustment level
<i>S</i>	Initial Setting level
<i>C</i>	Communication level
<i>F</i>	Advanced-Function level
<i>U</i>	User calibration level

5.2 Moving among Levels

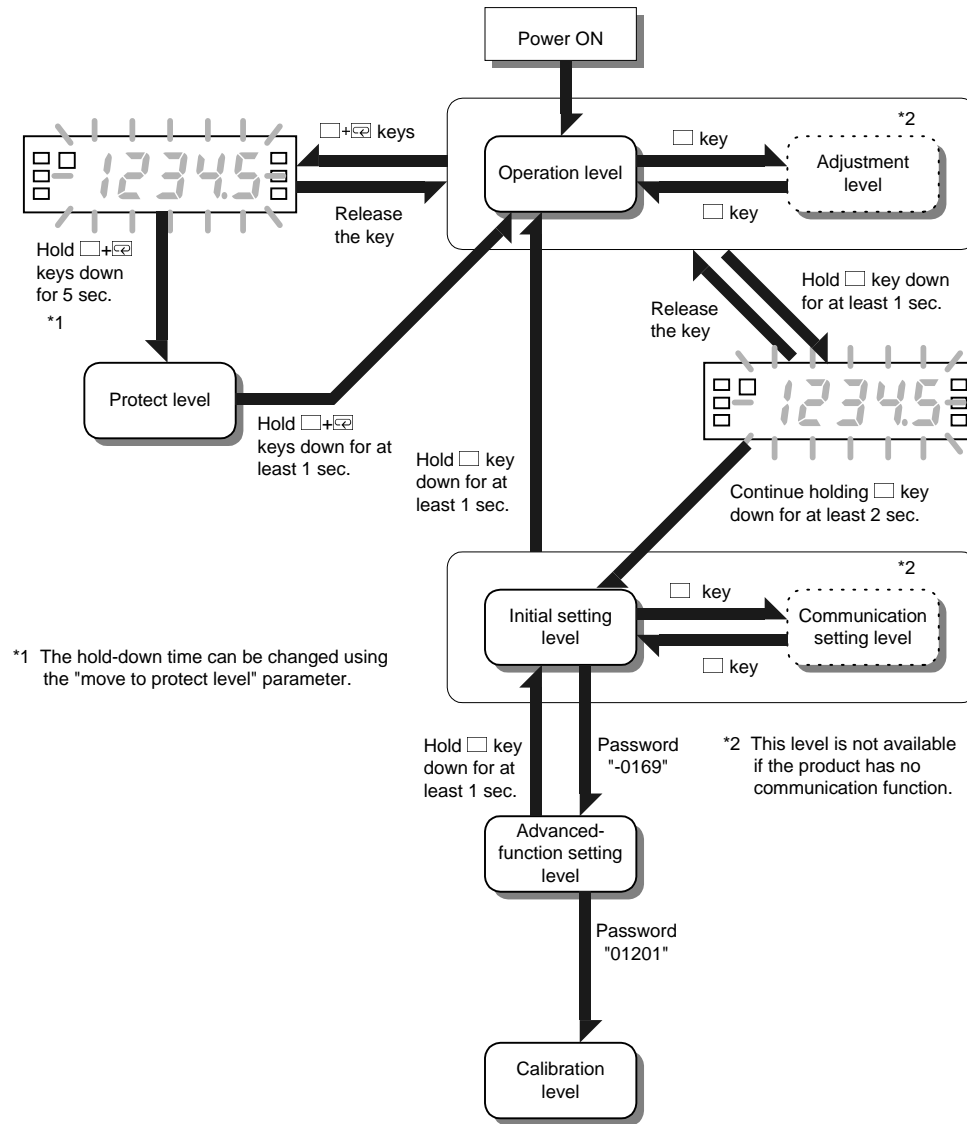

Power the product off and then on again to exit from calibration level.

OPERATION

Moving to the protect level

Press the $\square + \text{[Enter]}$ keys simultaneously and hold them down for at least 5 seconds. The main indicator starts blinking and then the product enters the protect level. The time required for moving to the protect level can be changed using the “move to protect level” parameter at the advanced-function setting level.

To return from the protect level to the operation level, press the $\square + \text{[Enter]}$ keys simultaneously and hold them down for at least one second.

Moving to the adjustment level

Press the \square key at the operation level.

When you release the key, the product enters the adjustment level.

To return from the adjustment level to the operation level, press the \square key.

Moving to the initial setting level

Press the \square key and hold it down for one second.

The main indicator starts blinking.

Continues holding the key down further for at least two seconds.

The product will return to the initial setting level.

To return from the initial setting level to the operation level, press the \square key and hold it down for at least one second.

Moving to the communication setting level

Press the \square key at the initial setting level. (Release the key within one second). When you release the key, the product enters the communication setting level.

To return from the communication setting level to the initial setting level, use the \square key.

Moving to the advanced-function

Moving to the advanced-function setting level involves some particular steps. Proceed as follows.

Procedure

A. Move to the initial setting level and press the [Enter] key to display the "advanced-function setting level" parameter.

- Parameter “ $\text{P}\bar{0}\bar{0}\bar{0}$ ” will appear on the main indicator.

B. Press the [0] key to cause "0" to appear on the main indicator.

C. Press the [0] key again to allow the password to be changed.

D. Use the [0] and [ZERO] keys to enter a password of “-0169”.

E. Press the  key to save the password.

- If the password is correct, the product enters the advanced-function setting level.
- If the password is incorrect, the product remains at the initial setting level and its main indicator displays the next initial setting parameter.

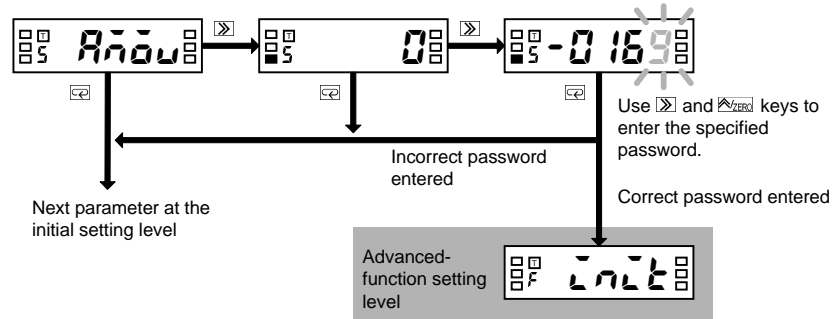

5.3 Parameters

Setting items at each level are called “parameters”.

Use the  key to select a parameter.

If the input range is changed, some parameters are set to default values.

Therefore, set the input range first.

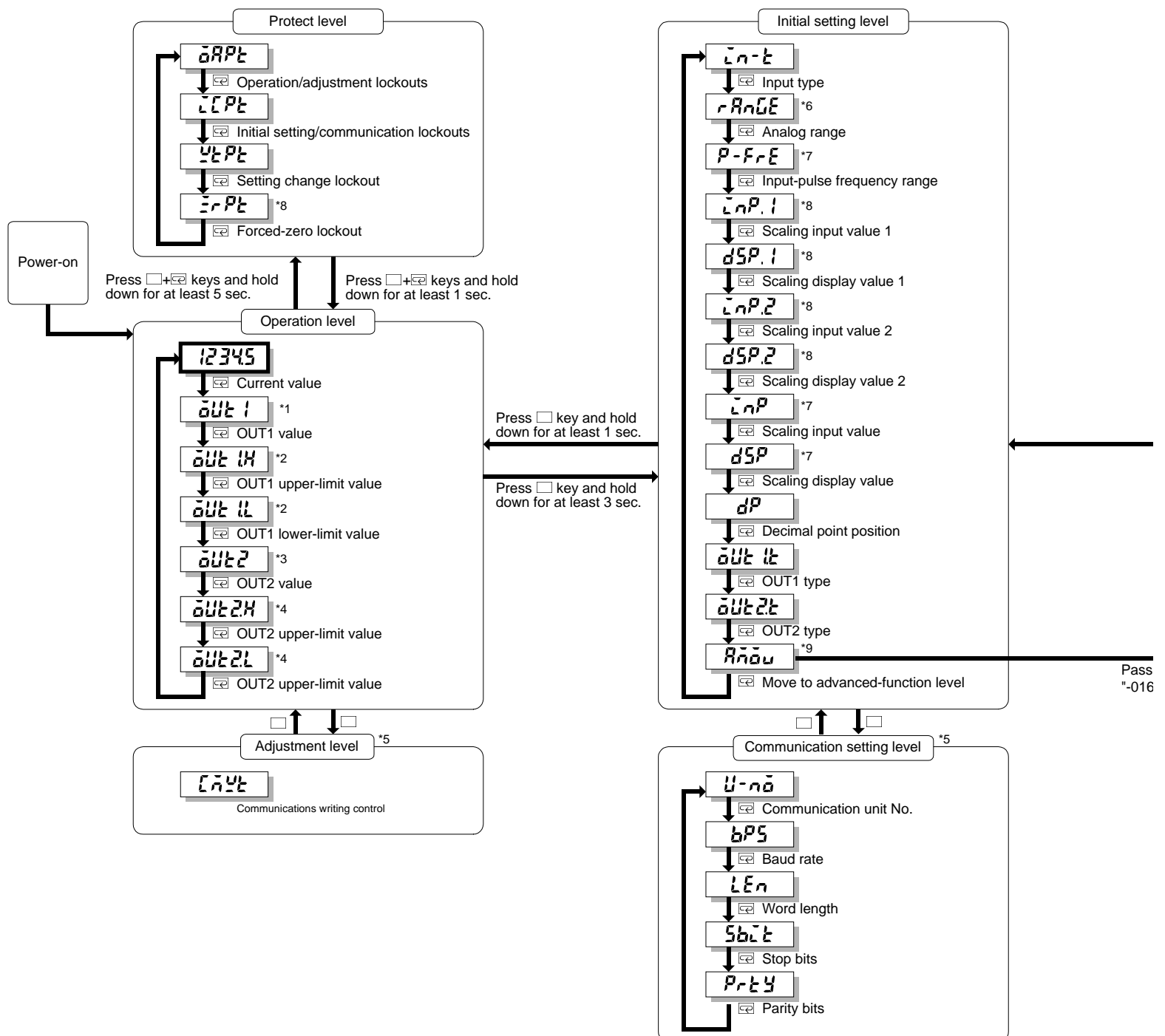

Pass
*-016

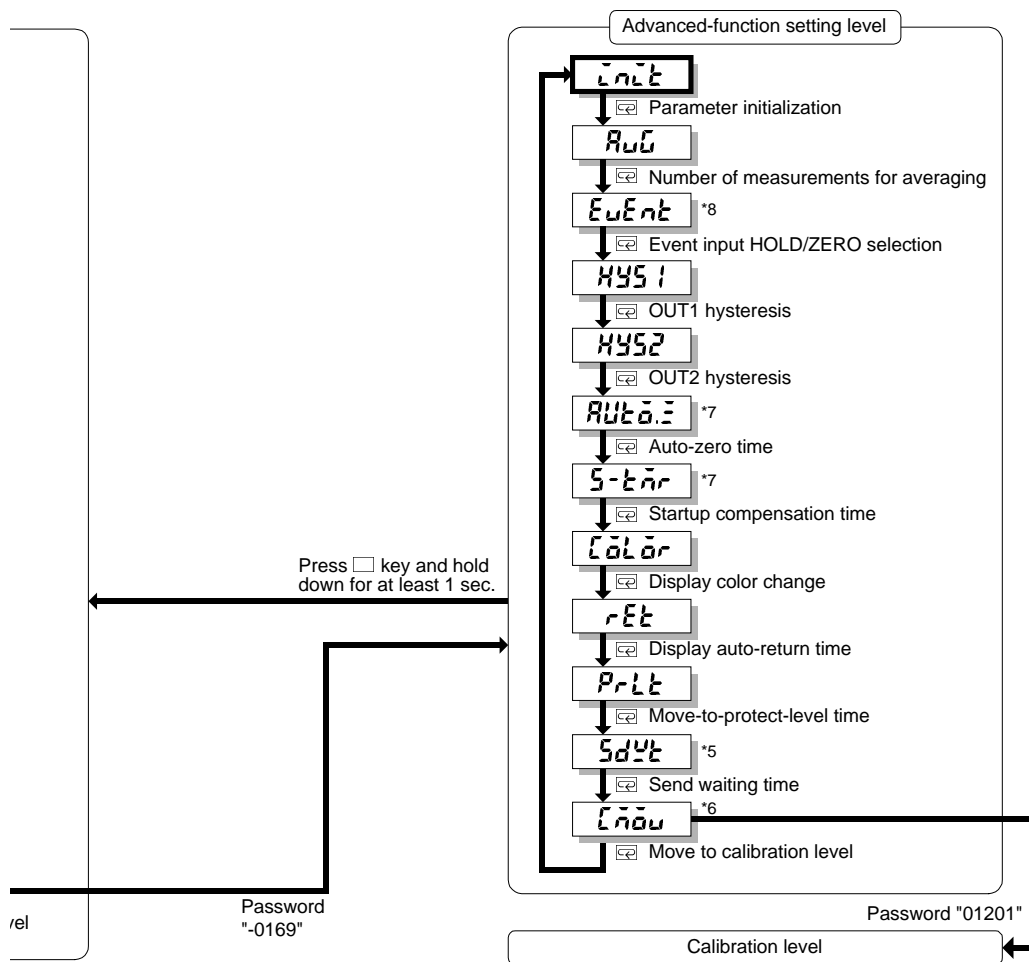

- *1 Displayed when parameter "OUT1 type" is set to "upper or lower limit".
- *2 Displayed when parameter "OUT1 type" is set to "upper and lower limits".
- *3 Displayed when parameter "OUT2 type" is set to "upper or lower limit".
- *4 Displayed when parameter "OUT2 type" is set to "upper and lower limits".
- *5 Accessible when the product has the communication function.
- *6 Displayed when parameter "input type" is set to "analog".
- *7 Displayed when parameter "input type" is set to "pulse".
- *8 Displayed when parameter "input type" is set to "analog" or "remote".
- *9 Displayed when parameter "initial setting/communication lockouts" is set to "0".

5.4 Set Values

Parameter settings are called “**set values**”.
Set values include those consisting of “numerics” and “alphabets”.

A state in which a set value is being displayed on the main indicator is called “**the monitor state**”.

A state in which a set value can be changed is called “**the change state**”.

Perform the following steps to display or change a set value.

Procedure



A. Press the  key when a parameter is displayed on the main indicator. The product enters the monitor state and the set value of the parameter will be displayed on the main indicator.

- When the product is in the monitor state, “SV” in the operation indicator section is illuminated, indicating the readout on the main indicator is a set value.

B. If you do not want to change the set value, press the  key in the monitor state to go to the next parameter.

C. Press the  key in the monitor state to cause the product to enter the change state.

- A digit that can be changed will start blinking.

D. Use the  and  key to change the set value.

- If no key is operated for five seconds, the product saves the current value and returns to the monitor state automatically.

E. Press the  key to go to the next parameter.

- The change in setting is saved in memory.

TIPS

During setting of operation or adjustment level parameters, the return action of the product varies depending on the “display auto-return time” setting.

The display auto-return time defaults to ten seconds. If the “display auto-return time” is set to less than five seconds, e.g., three seconds, no key operation for three seconds in the change state will return the product to the current value display mode, not to the monitor state.

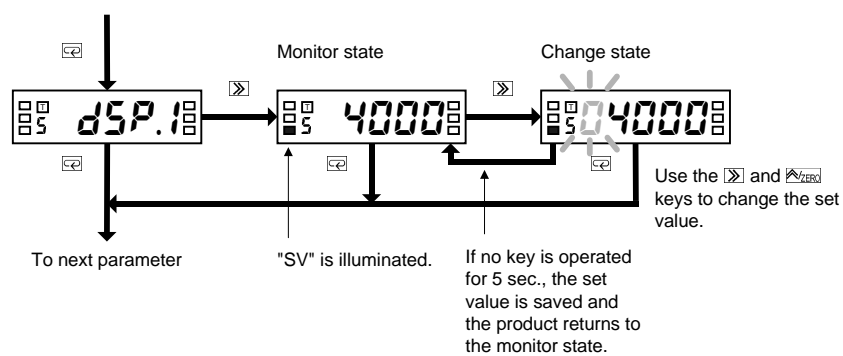

5.5 Operation Level

Operation Level

■ Viewing and Changing OUT set values

OUT 1

OUT 1.H

OUT 1.L

OUT 2

OUT 2.H

OUT 2.L

The operation level allows you to check and change OUT set values.

The product continues measuring in the middle of checking and changing OUT set values.

Procedure



A. Press the  key several times until parameter OUT2 is displayed on the main indicator.

B. Press the  key to display the OUT2 value on the main indicator.

- The product enters the monitor state and shows the OUT2 value on the main indicator.
- "SV" in the operation indicator section is illuminated, indicating the value shown on the main indicator is a set value.
- If you simply want to check the set value, proceed to step **E**.

C. Press the  key in the monitor state to cause the product to enter the change state.

- A digit that can be changed will start blinking.

D. Use the  and  key to change the set value.

- If no key is operated for five seconds, the product saves the current value and returns to the monitor state automatically.

E. Press the  key several times to return to the current value display mode.

- The change in setting is saved in memory.

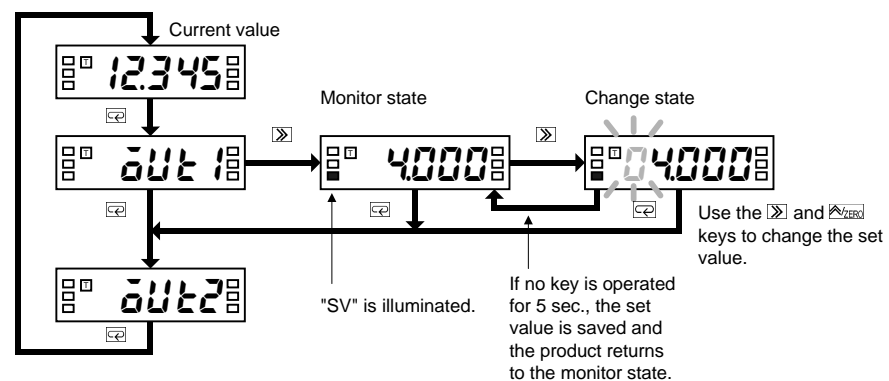

OPERATION

Available OUT set values and their indications are as follows.

OUT set value	Indication	Description
OUT1 value	OUT 1	When the process value increases or decreases to this value, comparative output 1 is provided.
OUT1 upper-limit value	OUT 1H	When the process value falls outside the range specified by these values, comparative output 1 is provided.
OUT1 lower-limit value	OUT 1L	
OUT2 value	OUT 2	When the process value increases or decreases to this value, comparative output 2 is provided.
OUT2 upper-limit value	OUT 2H	When the process value falls outside the range specified by these values, comparative output 2 is provided.
OUT2 lower-limit value	OUT 2L	

■ Forced-zero operation

Note

The forced-zero operation is not available if the input type is set to "pulse".

The forced-zero operation allows you to shift the current value to zero forcedly. For details, refer to **CHAPTER 6 FUNCTION DESCRIPTION**.

Procedure (for forced-zero operation)

A. Press the  key when a current value is displayed on the main indicator. (Release the key within one second).

- The current value will be shifted to zero.
- "ZERO" in the operation indicator section is illuminated, indicating the current value has been shifted to zero.

Procedure (for forced-zero release operation)

B. Press the  key and hold it down for at least one second when a shifted value is displayed.

- The shifted value will be restored to the current value.
- "ZERO" in the operation indicator section will go off, indicating the current value is no longer shifted.

TIPS

If the  key on the front panel is used for executing the forced-zero operation, the forced-zero process is stored in EEPROM. But if the forced-zero operation is executed via the event input terminal or communications, the process is not stored.

If the current value is not normal (e.g., the input signal is invalid, the process value is outside the displayable range, or no measurements are made), the forced-zero function is inoperative.

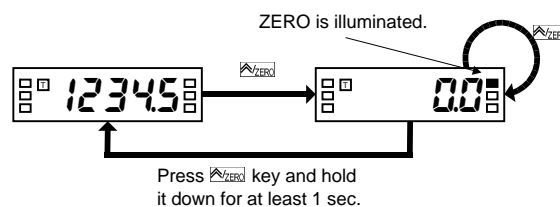

5.6 Communication Writing Control

Adjustment level



(CMWT)

Communication writing can be enabled or disabled.

Communication reading is always enabled, irrespective of this parameter setting.

Parameter	Set value	Description
CnVt	ōFF	Communication writing is disabled.
	ōn	Communication writing is enabled.

Procedure

TIPS

No operation for ten seconds at the adjustment level causes the product to return to the current value display mode at the operation level automatically.

A. Press the key at the operation level to move to the adjustment level.

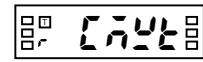

"r" appears.

- "r" will appear on the level indicator, indicating the product has entered the adjustment level.

B. Press the key to display the set value of the parameter on the main indicator.



"SV" is illuminated.

- The current set value will appear on the main indicator.

C. Press the key again.



- The set value will start blinking, indicating the product is in the change state.

D. Use the key to change the set value.



E. Press the key to save the change.

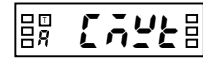

- The change is saved and then the main indicator returns to the parameter display mode.

F. Press the key to return to the operation level.



OPERATION

5.7 Key Protect Setting

Protect level

0APPt

1CPTt

2UPt

3rPt

Key protect includes “operation/adjustment lockouts”, “initial setting/communication lockouts”, “setting change lockout” and “forced-zero lockout”, and allows restrictions on various setting changes.

Operation/ Adjustment Lockouts

This types of key protect restrict the key operation at the operation and adjustment levels.

Parameter	Set value	Operation level		Move to adjustment level
		Current value display	OUT set value display	
0APPt	0	Enable	Enable	Enable
	1	Enable	Enable	Disable
	2	Enable	Disable	Disable

Initial Setting/ Communication Lockouts

This types of key protect restrict the "moving among levels" operation.

Parameter	Set value	Move to initial setting level	Move to communication setting level	Move to advanced-function setting level
1CPTt	0	Enable	Enable	Enable
	1	Enable	Enable	Disable
	2	Disable	Disable	Disable

Setting Change Lockout

This type of key protect restricts the key operation for setting changes.

It prohibits the product from entering the change state, except that the following operation is allowed.

- Changes in set values of all parameters at the protect level
- Move to the advanced-function level
- Move to the calibration level

Parameter	Set value	Key operation for setting changes
2UPt	0FF	Enable
	0n	Disable

Forces-zero Lockout

This type of key protect restricts the key operation that activates or deactivates the forced-zero function.

It has no effect on forced-zero operation via the event input terminal.

Parameter	Set value	Key operation for activating or deactivating the forced-zero function
3rPt	0FF	Enable
	0n	Disable

TIPS

Appropriate setting of the "move-to-protect-level time" parameter allows you to change the time required for the product to move to the protect level. The move-to-protect-level time is factory set to 5 seconds.

Procedure

A. When the product is at the operation level, press the + keys and hold them down for at least five seconds to enter the protect level.

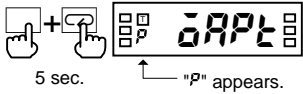

- "P" will appear on the level indicator, indicating the product has entered the protect level.

B. Press the key several times until the desired parameter appears on the main indicator.



C. Press the key to display the set value of the parameter on the main indicator.

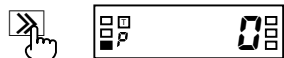

- The current set value will appear on the main indicator.

D. Press the key again.



- The current set value will start blinking, indicating the product is in the change state.

E. Use the /ZERO key to change the set value.



F. Press the key to go to the next parameter.

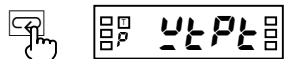

- The change is saved.

G. Press the + keys and hold them down for at least one second to return to the operation level.



OPERATION

5.8 Selecting an Input Type

Initial setting level

Input

This parameter allows you to select one from three input types.

Parameter	Set value	Description
Input	ANALG	Analog: The product can be used as a process meter.
	PULSE	Pulse: The product can be used as a tachometer.
	remt	Remote: The product can be used as a digital data indicator.

Procedure

TIPS

A change in input type initializes some parameters.

- When the input type is set to "analog": Parameters "Input", "dSP.1", "Input.2", "dSP.2" and "dP" are initialized according to the current analog range. The forced-zero function is deactivated.

- When the input type is set to "pulse": Parameter "dP" is initialized according to the current input-pulse frequency range.

- When the input type is set to "remote": Parameters "Input", "dSP.1" and "dSP.2" are set to "-19999" and "Input.2" and "dSP.2" are set to "99999". Parameter "dP" is set to "00000". The forced-zero function is deactivated. Data downloading is set to "enable".

OPERATION

A. When the product is at the operation level, press the  key and hold it down for at least three seconds to enter the initial setting level.

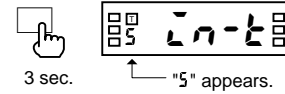

- "5" will appear on the level indicator, indicating the product has entered the initial setting level.
- The first parameter at the initial setting level is "Input".

B. Press the  key to display the set value of the parameter on the main indicator.

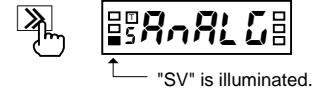

- The current set value will appear on the main indicator.

C. Press the  key again.

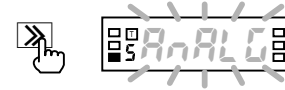

- The current set value will start blinking, indicating the product is in the change state.

D. Use the  key to change the set value.



E. Press the  key to go to the next parameter.



- The change is saved.

F. Specify the values of other parameters related to the input type. (Refer to the Appendix).

G. Press the  key and hold it down for at least one second to return to the operation level.



5.9 Selecting an Analog Range

Initial setting level

rAnGE

This parameter allows you to select an analog input range.

Before selecting an analog range, you must set the input type parameter to “analog”.

Parameter	Set value	Measuring range
rAnGE	4-20	4.00 to 20.00 mA/ 0.00 to 20.00 mA
	1-5	1.000 to 5.000V/ 0.000 to 5.000V
	5	-5.000 to 5.000V
	10	-10.000 to 10.000V

Procedure

TIPS

A change in analog range initializes some parameters.

- Parameters “LnP.1”, “dSP.1”, “LnP.2”, “dSP.2” and “dP” are initialized according to the current analog range. The forced-zero function is deactivated.

A. When the product is at the operation level, press the key and hold it down for at least three seconds to enter the initial setting level.

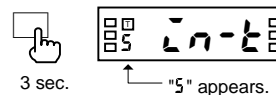

- “5” will appear on the level indicator, indicating the product has entered the initial setting level.

B. Press the key several times until parameter “rAnGE” appears on the main indicator.



C. Press the key to display the set value of the parameter on the main indicator.



- The set value representing the current analog range will appear on the main indicator.

D. Press the key again.



- The set value will start blinking, indicating the product is in the change state.

E. Use the key to change the set value.



F. Press the key to go to the next parameter.



- The change is saved.

G. Specify the values of other parameters related to the analog range. (Refer to the Appendix).

H. Press the key and hold it down for at least one second to return to the operation level.



OPERATION

5.10 Selecting an Input-pulse Frequency Range

Initial setting level

P-FrE

This parameter allows you to select an input-pulse frequency range. The value of the parameter represents the upper limit of available ranges.

Before selecting an input-pulse frequency range, you must set the input type parameter to “pulse”.

Parameter	Set value	Description
P-FrE	30	Measuring range: 0.05 to 30.00 Hz
	50	Measuring range: 0.1 to 5000.0 Hz

If input signals come from relay contacts, set the range to “30 Hz”. Doing so eliminates chattering noise from input signals.

Procedure

TIPS

A change in input-pulse frequency range initializes some parameters.

- Parameters “LrP”, “dSP” and “dP” are initialized according to the current input-pulse frequency range.

OPERATION

A. When the product is at the operation level, press the  key and hold it down for at least three seconds.

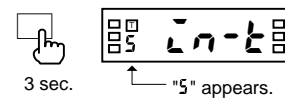

- “5” will appear on the level indicator, indicating the product has entered the initial setting level.

B. Press the  key several times until parameter “P-FrE” appears on the main indicator.



C. Press the  key to display the set value of the parameter on the main indicator.

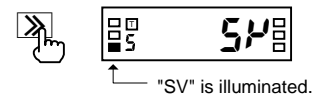

- The current set value of the input-pulse frequency range will appear on the main indicator.

D. Press the  key again.



- The set value will start blinking, indicating the product is in the change state.

E. Use the  key to change the set value.

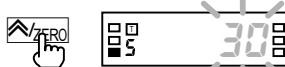

F. Press the  key to go to the next parameter.



- The change is saved.

G. Specify the values of other parameters related to the input-pulse frequency range. (Refer to the Appendix).

H. Press the  key and hold it down for at least one second to return to the operation level.



5.11 Specifying the Scaling Factor for Analog Input/Digital Data Display

Initial setting level

INP.1

dSP.1

INP.2

dSP.2

These parameters allow you to specify the scaling factor.

Before specifying the scaling factor, you must set the input type parameter to "analog" or "remote".

Parameter	Set value	Description
INP.1	19999 ~ 99999	Any input value
dSP.1	19999 ~ 99999	Output value (readout) corresponding to INP.1
INP.2	19999 ~ 99999	Any input value
dSP.2	19999 ~ 99999	Output value (readout) corresponding to INP.2

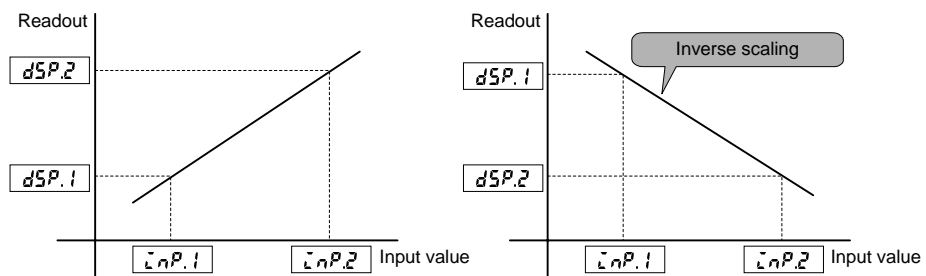

The input value can be set by teaching.

Inverse scaling where readout decreases with increasing input is also possible.

To allow a readout of 0.0 when the input value is 4.2 mA and a readout of 100.0 when the input value is 20 mA, for example, set the parameters as follows.

- INP.1 = 4.20
- dSP.1 = 0
- INP.2 = 20.00
- dSP.2 = 1000

Specify the decimal point position of the display value with parameter dP.

For details, refer to **Section 6.2 Scaling**.

Procedure

A. When the product is at the operation level, press the key and hold it down for at least three seconds to enter the initial setting level.

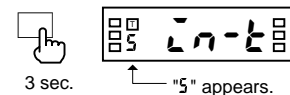

- "5" will appear on the level indicator, indicating the product has entered the initial setting level.

B. Press the key several times until parameter "INP.1" appears on the main indicator.

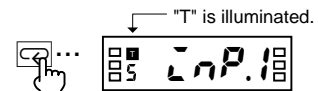

- "T" will be illuminated, indicating teaching of this parameter is possible.
- For the procedure of teaching, refer to the next page.

C. Press the key to display the set value of the parameter on the main indicator.

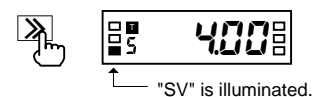

- The current set value of parameter "INP.1" will appear on the main indicator..

TIPS

The decimal point position of parameters INP.1 and INP.2 is automatically set as follows.

- When the input type is set to "analog":
 - 4 to 20 mA: 000.00
 - 1 to 5V: 00.000
 - ±5V: 00.000
 - ±10V: 000.00
- When the input type is set to "remote":
 - 00000

- D.** Press the key again.
- The set value starts blinking, indicating the product is in the change state.
- E.** Use the and keys to change the set value.
- F.** Press the key to go to the next parameter “dSP.1”.
- The change is saved and then “dSP.1” will appear on the main indicator.
- G.** Repeat steps **C** to **F** for parameters “*i*nP.2” and “dSP.2”.
- When you finish setting of parameter “dSP.2”, parameter “dP” will appear on the main indicator.
- H.** Press the key and hold it down for at least one second to return to the operation level.
- 1 sec.

Teaching The teaching function allows you to specify the value of parameters “*i*nP.1” and “*i*nP.2” without the need for any front panel key input.

Procedure

- I.** Following step **C** (the product is in the monitor state), press the key.
- “T” will start blinking, indicating the product is in teaching mode.
 - Key entry permits the actual process value to be displayed on the main indicator.
- J.** Press the key again.
- The actual process value is set as the input value and then the product will return to the monitor state.
 - Pressing the key instead of the key in teaching mode cancels the teaching mode and the display on the main indicator changes to the next parameter.

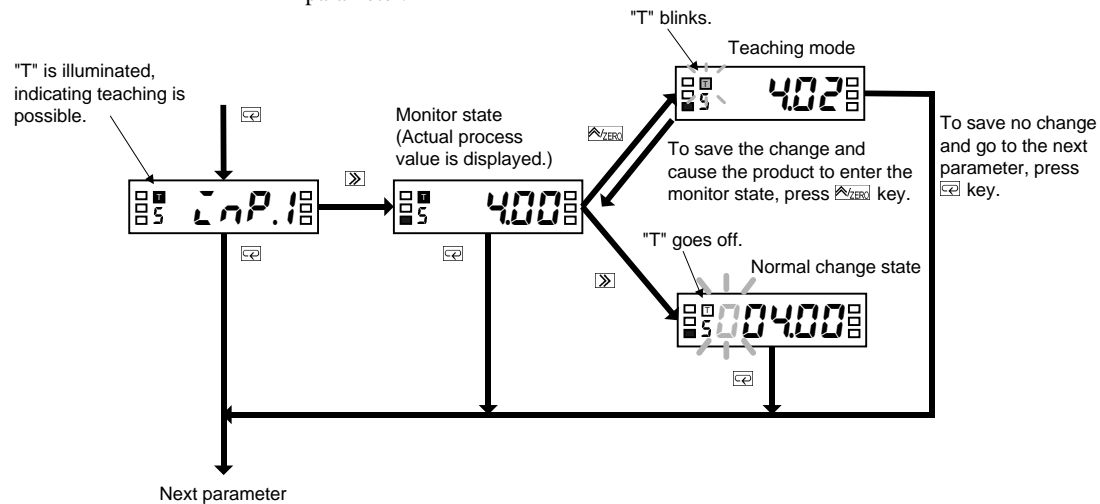

5.12 Specifying the Scaling Factor for Input Pulse Frequency

Initial setting level



These parameters allow you to specify the scaling factor.

Before specifying the scaling factor, you must set the input type parameter to “pulse”.

Parameter	Set value	Description
$\bar{L}nP$	19999 ~ 99999	Any input value
dSP	19999 ~ 99999	Output value (readout) corresponding to $\bar{L}nP$

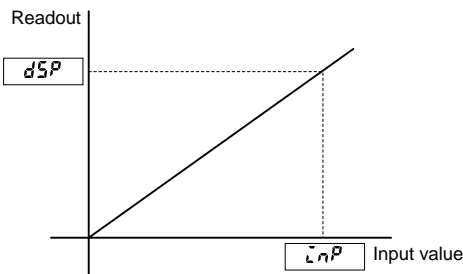

The input value can be set by teaching.

To allow a readout of 10.000 when the input value is 4.2 kHz (= 4200 Hz), for example, set the parameters as follows.

- $\bar{L}nP = 4200$
- $dSP = 10000$

Specify the decimal point position of the display value with parameter dP .

For details, refer to **Section 6.2 Scaling**.

TIPS

The decimal point position of parameter “ $\bar{L}nP$ ” is automatically set depending on setting of the input-pulse frequency range as follows.

- 30 Hz: 0000.00
- 5 kHz: 000000

OPERATION

Procedure

A. When the product is at the operation level, press the key and hold it down for at least three seconds to enter the initial setting level.

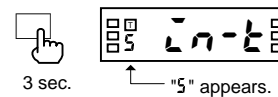

- “5” will appear on the level indicator, indicating the product has entered the initial setting level.

B. Press the key several times until parameter “ $\bar{L}nP$ ” appears on the main indicator.

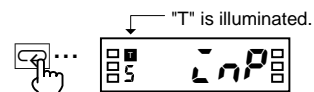

- “T” will be illuminated, indicating teaching of this parameter is possible.
- For the procedure of teaching, refer to the next page.

C. Press the key to display the set value of the parameter on the main indicator.

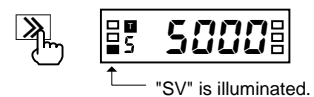

- The current set value of parameter “ $\bar{L}nP$ ” will appear on the indicator.

D. Press the key again.



- The set value will start blinking, indicating the product is in the change state.

E. Use the and keys to change the set value.

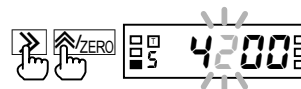

F. Press the  key to go to the next parameter.



- The change is saved and then “dSP” will appear on the main indicator.



G. Press the  key and hold it down for at least one second to return to the operation level.





Teaching The teaching function allows you to specify the value of parameter “L nP” without the need for front panel key input.

Procedure

H. Following step **C** (the product is in the monitor state), press the  key.

- “T” will start blinking, indicating the product is in teaching mode.
- Key entry permits the actual process value to be displayed on the main indicator.

I. Press the  key again.

- The actual process value is set as the input value and then the product will return to the monitor state.
- Pressing the  key instead of the  key in teaching mode cancels the teaching mode and the display on the main indicator changes to the next parameter.

OPERATION

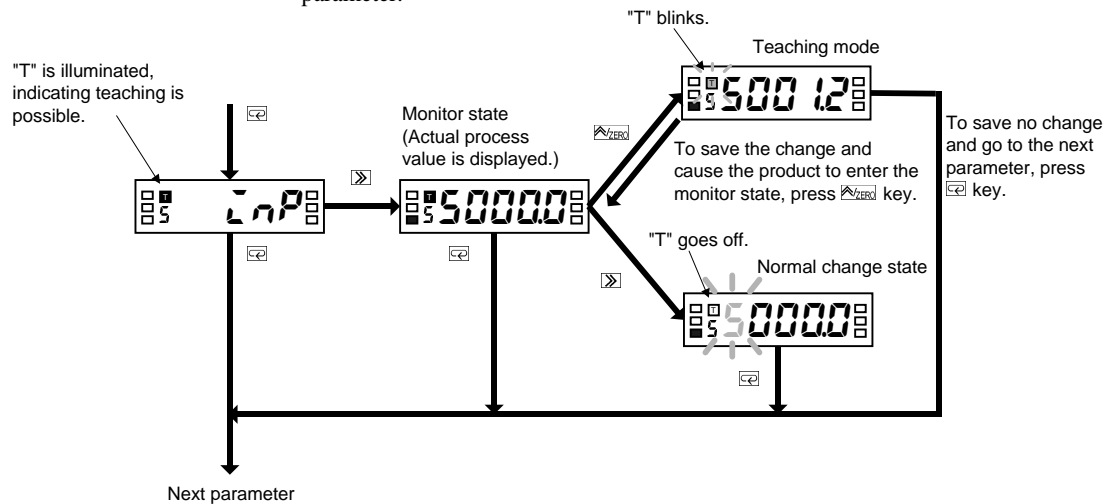

**How to
Determine
Appropriate
Scaling Factors**

To minimize the scaling operation error, select such a scaling factor that permits the largest possible number of digits to be contained in scaling display values (DSP).

The relationship between the scaling input and display values for input pulse frequency is represented by the following equation.

$$\text{Scaling display value} = \alpha \text{ (multiplication factor)} \times \text{input frequency (Hz)}$$

Where $\alpha = \text{DSP}/\text{INP}$

α is often an indivisible number such as 5.654866... particularly when the input value is converted to a circumferential velocity. This is because such a conversion involves π .

There are innumerable combinations of scaling input values (INP) and scaling display values (DSP) that result in $\alpha = 5.654866...$ as follows.

INP (Hz)	DSP
1	5.654866...
2	11.30973...
5	28.27433...
10	56.54866...
...	

On the other hand, DSPs that are programmable are limited to 5-digit integers. This means that DSPs must be rounded off to the nearest integers as follows.

INP (Hz)	Programmable DSP
1	00006
2	00011
5	00028
10	00057
...	

Hence, if the input frequency is 1000 Hz, the error between the scaling result and the ideal value increases with the decreasing number of digits contained in the DSP.

INP (Hz)	Programmable DSP	Scaling result (readout)	Ideal value	Error
1	00006	6000	5655	345
2	00011	5500	5655	155
5	00028	5600	5655	55
10	00057	5700	5655	45
...				

Select a combination of the DSP and INP so that the scaling output contains the largest possible number of digits. Doing so minimizes the scaling operation error.

5.13 Specifying the Decimal Point Position

Initial setting level



This parameter allows you to specify the decimal point position of the display value.

Parameter	Set value	Description
dP	0.0000	Readouts are given to four decimal places.
	00.000	Readouts are given to three decimal places.
	000.00	Readouts are given to two decimal places.
	0000.0	Readouts are given to one decimal place.
	00000	Readouts are given as integers.

Procedure

A. When the product is at the operation level, press the key and hold it down for at least three seconds to enter the initial setting level.

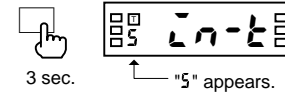

- “5” will appear on the level indicator, indicating the product has entered the initial setting level.

B. Press the key several times until parameter “dP” appears on the main indicator.

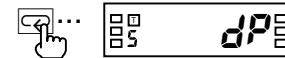

C. Press the key to display the set value of the parameter.

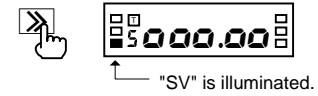

- The current set value for the decimal point position will appear on the main indicator.

D. Press the key again



- The set value will start blinking, indicating the product is in the change state.

E. Use the key to change the set value.



F. Press the key to go to the next parameter.

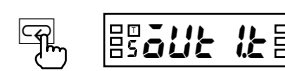

- The change is saved.

G. Press the key and hold it down for at least one second to return to the operation level.



5.14 Selecting the Output Operating Action

Initial setting level

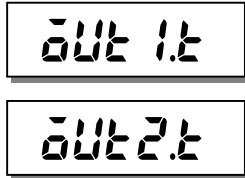

These parameters allow you to select the operating action of outputs 1 and 2 respectively.

Parameter	Set value	Description
OUT 1. or OUT 2.	H \bar{L}	Upper limit: Upper-limit action
	L \bar{O}	Lower limit: Lower-limit action
OUT 2.	H \bar{L} -L \bar{O}	Upper and lower limits: Outside-the-range action

For details, refer to **Section 6.8 Comparative Output**.

Procedure

TIPS

- To specify the OUT set value for the upper or lower-limit action, use parameters OUT 1 and OUT 2.
- To specify the OUT set values for the outside-the-range action, use parameters OUT 1.H, OUT 1.L, OUT 2.H and OUT 2.L.

A. When the product is at the operation level, press the key and hold it down for at least three seconds to enter the initial setting level..

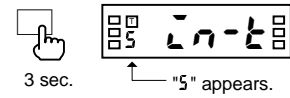

- "5" will appear on the level indicator, indicating the product has entered the initial setting level.

B. Press the key several times until parameter "OUT 1." appears on the main indicator.



C. Press the key to display the set value of the parameter on the main indicator.



- The current set value for the type of comparative output will appear on the main indicator.

D. Press the key again.

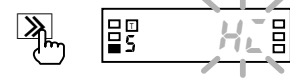

- The set value will start blinking, indicating the product is in the change state.

E. Use the key to change the set value.



F. Press the key to display parameter "OUT 2." on the main indicator.



- The change is saved and then the next parameter "OUT 2." will appear on the main indicator.

G. Repeat steps **C** to **F** for parameter "OUT 2.".



- Parameter "A \bar{N} O" will appear on the main indicator when you finish setting of parameter "OUT 2.".

H. Press the key and hold it down for at least one second to return to the operation level.



5.15 Specifying Communication Parameters

Communication setting level

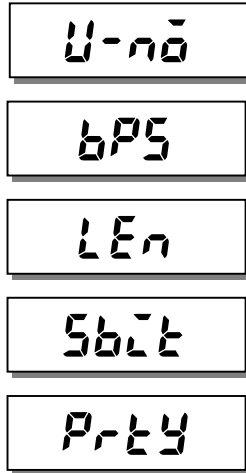

Communication parameters are to be specified at the communication setting level.

Parameter	Set value	Description
U-nō	0 ~ 99	Communication unit No.
bPS	1.2/2.4/4.8 /9.6/19.2	Baud rate (1,200, 2,400, 4,800, 9,600, 19,200 bps)
LEN	7/8	Word length (7 or 8)
Sbit	1/2	Stop bit length (1 or 2)
Prty	nōnE/EuEn /ōdd	Parity bits (None, Even, or Odd)

When connecting multiple products to one host PC, exercise care to avoid assigning the same ID number to more than one product.

Set other communication parameters according to the host PC setting.

Procedure

A. When the product is at the operation level, press the key and hold it down for at least three seconds to enter the initial setting level.

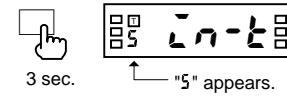

- "5" will appear on the level indicator, indicating the product has entered the initial setting level.

B. Press the key at the initial setting level.

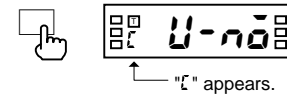

- "U" will appear on the level indicator, indicating the product has entered the communication setting level.

C. Press the key several times until the desired parameter appears on the main indicator.

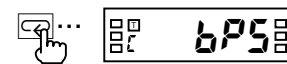

D. Press the key to display the set value of the desired parameter on the main indicator.

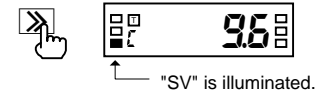

- The current set value will appear on the main indicator.

E. Press the key again.

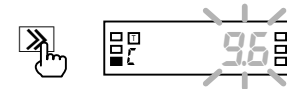

- The set value will start blinking, indicating the product is in the change state.

F. Use the key to change the set value.



G. Press the key to go to the next parameter.

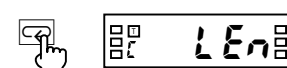

- The change is saved.

H. Repeat steps **C** to **G** for the remaining communication parameters.



I. Press the key to return to the initial setting level.

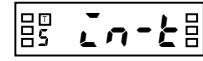

J. Press the key and hold it down for at least one second to return to the operation level.



1 sec.

OPERATION

5.16 Clearing All Parameters

Advanced-function setting level



The clear all function can be used to initialize all parameters to factory settings.

Parameter	Set value	Description
Init	OFF	—
Init	on	Parameters are all initialized.

This function is useful in restarting the setup of the product from the default state.

Procedure

A. When the product is at the operation level, press the key and hold it down for at least three seconds to enter the initial setting level.

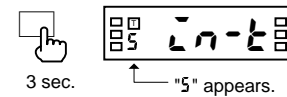

- “5” will appear on the level indicator, indicating the product has entered the initial setting level.

B. Press the key several times until parameter “F” is displayed, and then enter password “-0169”.

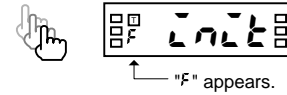

- “F” will appear on the level indicator, indicating the product has entered the advanced-function setting level.
- The first parameter at the advanced-function setting level is “Init”.
- For details on how to move to the advanced-function setting level, refer to **Section 5.2 Moving among Levels**.

C. Press the key to display the set value of parameter “Init” on the main indicator.

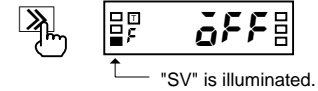

- Set value “OFF” will appear on the main indicator.

D. Press the key again.



- The set value will start blinking, indicating the product is in the change state.

E. Use the key to change the set value to “on”.



F. Press the key to go to the next parameter.

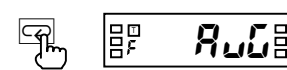

- All parameters are initialized.
- Parameter “Init” is also set to “OFF”.

G. Press the key and hold it down for at least one second to return to the initial setting level.

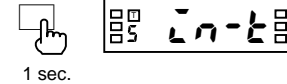

H. Press the key and hold it down for at least one second to return to the operation level.



5.17 Specifying the Number of Measurements for Averaging

Advanced-function setting level

AVG
(AVG)

This parameter allows you to specify the number of measurements for averaging.

Parameter	Set value	Description
AVG	OFF	No average processing
	2/4/8	Number of measurements for averaging (2, 4, or 8 times)

For details, refer to **Section 6.4 Average Processing**.

Procedure

A. When the product is at the operation level, press the  key and hold it down for at least three seconds to enter the initial setting level..

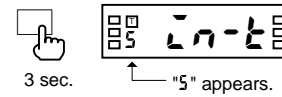

- "5" will appear on the level indicator, indicating the product has entered the initial setting level.

B. Press the  key several times until parameter "A n d u" is displayed, and then enter password "-0169".

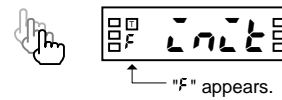

- "F" will appear on the level indicator, indicating the product has entered the advanced-function setting level.
- For details on how to move to the advanced-function setting level, refer to **Section 5.2 Moving among Levels**.

C. Press the  key several times until parameter "AVG" appears on the main indicator.

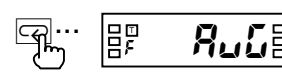

D. Press the  key to display the set value of parameter "AVG".

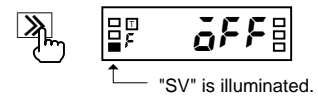

- The current set value for the number of measurements for averaging will appear on the main indicator.

E. Press the  key again.



- The set value will start blinking, indicating the product is in the change state.

F. Press the  key to change the set value.



G. Press the  key to go to the next parameter.



- The change is saved.

H. Press the  key and hold it down for at least one second to return to the initial setting level.



I. Press the  key and hold it down for at least one second to return to the operation level.



5.18 Specifying the Function of the Event Input

Advanced-function setting level

EVENT

(EVENT)

When the input type has been set to "analog" or "remote", this parameter allows you to specify the function of the event input (terminal ③).

Before specifying the function of the event input, you must set the input type to "analog" or "remote".

Parameter	Set value	Description
EVENT	HOLD	HOLD: The current process value is held.
	ZERO	ZERO: The current process value is forcedly shifted to zero.

For details, refer to **Section 6.5 Process Value Hold**.

Procedure

A. When the product is at the operation level, press the  key and hold it down for at least three seconds to enter the initial setting level..

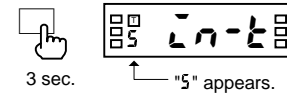

- "5" will appear on the level indicator, indicating the product has entered the initial setting level.

B. Press the  key several times until parameter "F" is displayed, and then enter password "-0169".

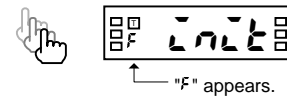

- "F" will appear on the level indicator, indicating the product has entered the advanced-function setting level.
- For details on how to move to the advanced-function setting level, refer to **Section 5.2 Moving among Levels**.

C. Press the  key several times until parameter "EVENT" appears on the main indicator.



D. Press the  key to display the set value of parameter "EVENT" on the main indicator.

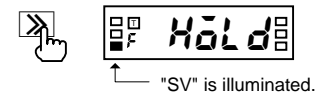

- The current set value will appear on the main indicator.

E. Press the  key again.



- The set value will start blinking, indicating the product is in the change state.

F. Use the  key to change the set value.



G. Press the  key to go to the next parameter.



- The change is saved.

H. Press the  key and hold it down for at least one second to return to the initial setting level.



5.18 Specifying the Function of the Event Input

- 1. Press the key and hold it down for at least one second to return to the operation level.



1 sec.



OPERATION

5.19 Specifying the Hysteresis

Advanced-function setting level

HYS 1

HYS 2

These parameters allow you to specify the hysteresis for each of comparative outputs 1 and 2.

Parameter	Set value	Description
HYS*	0 ~ 9999	0 to 9999: Hysteresis

The setting of the decimal point position parameter at the initial setting level is reflected on the decimal point position of the hysteresis.

For details, refer to **Section 6.9 Hysteresis**.

TIPS

A hysteresis setting of "0" is assumed to be a hysteresis setting of "1".

Procedure

A. When the product is at the operation level, press the  key and hold it down for at least three seconds to enter the initial setting level.

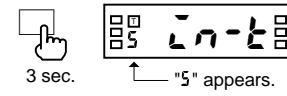

- "5" will appear on the level indicator, indicating the product has entered the initial setting level.

B. Press the  key several times until parameter "Pw00" is displayed, and then enter password "-0169".

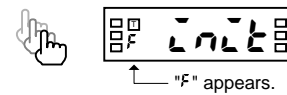

- "F" will appear on the level indicator, indicating the product has entered the advanced-function setting level.
- For details on how to move to the advanced-function setting level, refer to **Section 5.2 Moving among Levels**.

C. Press the  key several times until parameter "HYS 1" appears on the main indicator.



D. Press the  key to display the set value of parameter "HYS 1" on the main indicator.

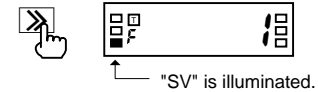

- The current set value will appear on the main indicator.

E. Press the  key again.



- The set value will start blinking, indicating the product is in the change state.

F. Use the  and  keys to change the set value.

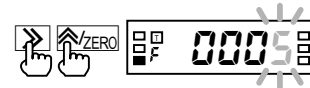

G. Press the  key to go to parameter "HYS 2".



- The change is saved.

H. Repeat steps **D** to **G** for parameter "HYS 2".



- The next parameter will appear on the main indicator when you finish setting of parameter "HYS 2".

I. Press the key and hold it down for at least one second to return to the initial setting level.



1 sec.

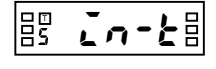

J. Press the key and hold it down for at least one second to return to the operation level.



1 sec.

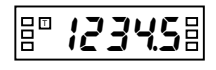

OPERATION

5.20 Specifying the Auto-zero Time

Advanced-function setting level



(AUTO.Z)

When the input type has been set to "pulse", this parameter allows you to specify the auto-zero time.

Before specifying the auto-zero time, you must set the input type to "pulse".

Parameter	Set value	Description
AUTO.Z	0.0 ~ 19.9	0.0 to 19.9 seconds: Auto-zero time

The auto-zero time is the length of time required for the product to return the readout to zero after pulse input interruption.

Set this parameter to a larger value than the expected time interval of input pulses (interval between input pulses). Failure to do so will result in incorrect measurements.

If the auto-zero time is too long, on the other hand, a long delay in lower-limit action in response to a stop of rotation may result.

In the following application where a pulse is produced per rotation, for example, the input pulse frequency is 0.2 to 100 Hz, which means the time interval of input pulses is 0.01 to 5 seconds.

The auto-zero time should therefore be set to five seconds or longer.

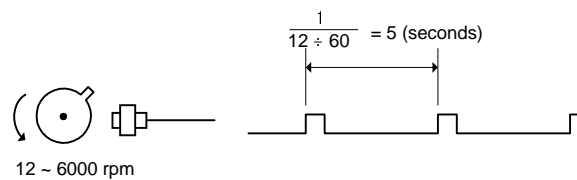

For details, refer to **Section 6.3 Auto-zero/Startup Compensation**.

Procedure

A. When the product is at the operation level, press the key and hold it down for at least three seconds to enter the initial setting level.

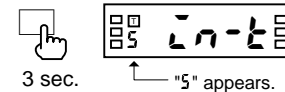

- "5" will appear on the level indicator, indicating the product has entered the initial setting level.

B. Press the key several times until parameter "AUTO.Z" is displayed, and then enter password "-0169".

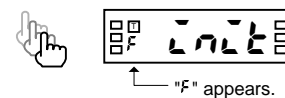

- "F" will appear on the level indicator, indicating the product has entered the advanced-function setting level.
- For details on how to move to the advanced-function setting level, refer to **Section 5.2 Moving among Levels**.

C. Press the key several times until parameter "AUTO.Z" appears on the main indicator.



D. Press the key to display the set value of parameter "AUTO.Z" on the main indicator.



- The current set value will appear on the main indicator.

E. Press the  key again.

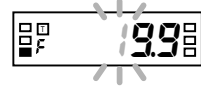

- The set value will start blinking, indicating the product is in the change state.

F. Use the  and  keys to change the set value.

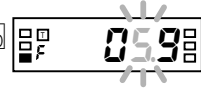

G. Press the  key to go to the next parameter.

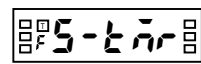

- The change is saved and the next parameter will appear on the main indicator.

H. Press the  key and hold it down for at least one second to return to the initial setting level.



1 sec.



I. Press the  key and hold it down for at least one second to return to the operation level.



1 sec.

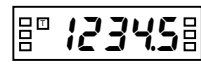

5.21 Specifying the Startup Compensation Time

Advanced-function setting level

5- \bar{t} \bar{r}

(S-TMR)

When the input type has been set to "pulse", this parameter allows you to specify the startup compensation time.

Before specifying the startup compensation time, you must set the input type to "pulse".

Parameter	Set value	Description
5- \bar{t} \bar{r}	0.0 ~ 99.9	0.0 to 99.9 seconds: Startup compensation time

The startup compensation time is a delay between power-on of the product and the start of measurement. This function is useful in preventing output from being produced until a rotator reaches a prescribed speed.

For details, refer to **Section 6.3 Auto-zero/Startup Compensation**.

Procedure

A. When the product is at the operation level, press the  key and hold it down for at least three seconds to enter the initial setting level.

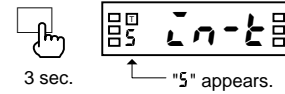

- "5" will appear on the level indicator, indicating the product has entered the initial setting level.

B. Press the  key several times until parameter "F \bar{r} \bar{t} \bar{r} " is displayed, and then enter password "-0169".

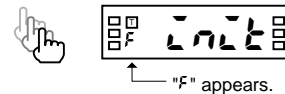

- "F" will appear on the level indicator, indicating the product has entered the advanced-function setting level.
- For details on how to move to the advanced-function setting level, refer to **Section 5.2 Moving among Levels**.

C. Press the  key several times until parameter "5- \bar{t} \bar{r} " appears on the main indicator.



D. Press the  key to display the set value of parameter "5- \bar{t} \bar{r} " on the main indicator.

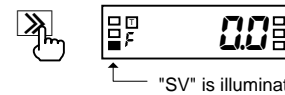

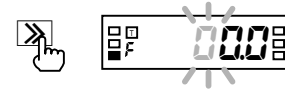

- The current set value of the startup compensation timer will appear on the main indicator.

E. Press the  key again.



- The set value will start blinking, indicating the product is in the change state.

F. Use the  and  keys to change the set value.

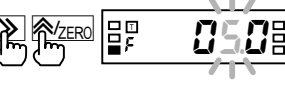

G. Press the  key to go to the next parameter.



- The change is saved.

H. Press the  key and hold it down for at least one second to return to the initial setting level.

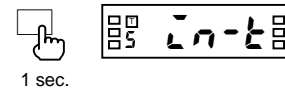

5.21 Specifying the Startup Compensation Time

- 1. Press the key and hold it down for at least one second to return to the operation level.



OPERATION

5.22 Changing the Display Color

Advanced-function setting level



This parameter allows you to change the display color of the main indicator.

Parameter	Set value	Description
CōLōr	Grn-r	Green – red: The display color is normally green, and changes to red at comparative output ON.
	Grn	Green: The display color is always green.
	rEd-G	Red – green: The display color is normally red, and changes to green at comparative output ON.
	rEd	Red: The display color is always red.

For details, refer to **Section 6.10 Display Color Change**.

Procedure

A. When the product is at the operation level, press the key and hold it down for at least three seconds to enter the initial setting level.

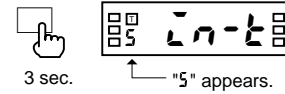

- "5" will appear on the level indicator, indicating the product has entered the initial setting level.

B. Press the key several times until parameter "Rnōw" is displayed, and then enter password "-0169".

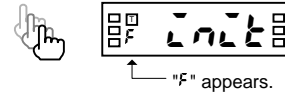

- "F" will appear on the level indicator, indicating the product has entered the advanced-function setting level.
- For details on how to move to the advanced-function setting level, refer to **Section 5.2 Moving among Levels**.

C. Press the key several times until parameter "CōLōr" appears on the main indicator.

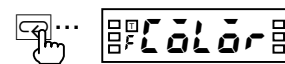

D. Press the key to display the set value of parameter "CōLōr" on the main indicator.

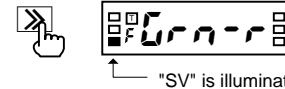

- The current set value of the display color will appear on the main indicator.

E. Press the key again.



- The set value will start blinking, indicating the product is in the change state.

F. Use the key to change the set value.



G. Press the key to go to the next parameter.

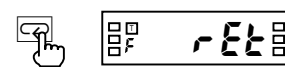

- The change is saved.

H. Press the key and hold it down for at least one second to return to the initial setting level.

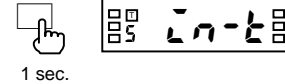

5.22 Changing the Display Color

1. Press the key and hold it down for at least one second to return to the operation level.



OPERATION

5.23 Changing the Display Auto-return Time

Advanced-function setting level



TIPS

If the display auto-return function is activated in the middle of parameter setting, the product saves the current value of the parameter and then returns to the current value display mode.

This parameter allows you to change the display auto-return time.

Parameter	Set value	Description
rEt	0	0 second: Display auto-return is not available.
	1 ~ 99	1 to 99 seconds: Display auto-return time

If no key is operated for a prescribed time, the product returns to the current value display mode at the operation level.

This prescribed time is called the display auto-return time.

Procedure

A. When the product is at the operation level, press the key and hold it down for at least three seconds to enter the initial setting level.

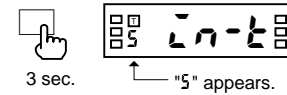

- "5" will appear on the level indicator, indicating the product has entered the initial setting level.

B. Press the key several times until parameter "rEt" is displayed, and then enter password "-0169".

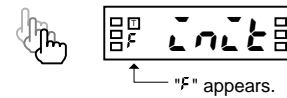

- "F" will appear on the level indicator, indicating the product has entered the advanced-function setting level.
- For details on how to move to the advanced-function setting level, refer to **Section 5.2 Moving among Levels**.

C. Press the key several times until parameter "rEt" appears on the main indicator.

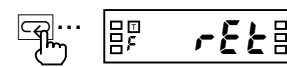

D. Press the key to display the set value of parameter "rEt" on the main indicator.

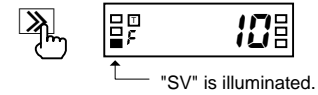

- The current set value of the display auto-return time will appear on the main indicator.

E. Press the key again.



- The set value will start blinking, indicating the product is in the change state.

F. Use the and keys to change the set value.



G. Press the key to go to the next parameter.



- The change is saved.

H. Press the key and hold it down for at least one second to return to the initial setting level.

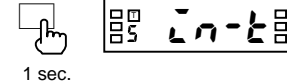

5.23 Changing the Display Auto-return Time

1. Press the key and hold it down for at least one second to return to the operation level.



1 sec.



OPERATION

5.24 Changing the Move-to-Protect-Level Time

Advanced-function setting level

Prlt

This parameter allows you to change the move-to-protect-level time.

Parameter	Set value	Description
Prlt	0 ~ 19	0 to 19 seconds: Move-to-protect-level time

If you press the + keys simultaneously and hold them down for a prescribed time (default: 5 seconds), the product enters the protect level. This prescribed time is called the move-to-protect-level time.

Depending on the setting of the parameter, the product moves from the operation level to the protect levels as follows.

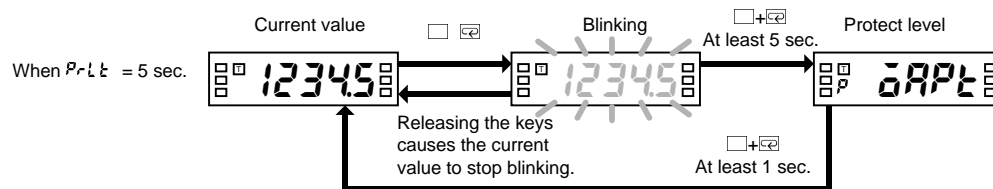

Procedure

OPERATION

TIPS

A move-to-protect-level time setting of "0" is assumed to be a setting of "1".

A. When the product is at the operation level, press the key and hold it down for at least three seconds to enter the initial setting level.

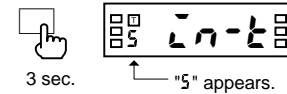

- "5" will appear on the level indicator, indicating the product has entered the initial setting level.

B. Press the key several times until parameter "Prlt" is displayed, and then enter password "-0169".

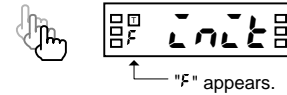

- "F" will appear on the level indicator, indicating the product has entered the advanced-function setting level.
- For details on how to move to the advanced-function setting level, refer to **Section 5.2 Moving among Levels**.

C. Press the key several times until parameter "Prlt" appears on the main indicator.



D. Press the key to display the set value of parameter "Prlt" on the main indicator.

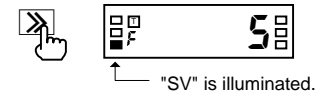

- The current set value of the move-to-protect-level time will appear on the main indicator.

E. Press the key again.



- The set value will start blinking, indicating the product is in the change state.

F. Use the and keys to change the set value.



G. Press the  key to go to the next parameter.



- The change is saved.

H. Press the  key and hold it down for at least one second to return to the initial setting level.



1 sec.

I. Press the  key and hold it down for at least one second to return to the operation level.



1 sec.

5.25 Changing the Send Waiting Time

Advanced-function setting level



(SDWT)

This parameter allows you to change the send waiting time.

Parameter	Set value	Description
5dwt	0 ~ 99	0 to 99 milliseconds: Send waiting time

The send waiting time is the time between reception of a command frame from the host PC and return of a response frame to the host PC.

To optimize the responsivity, you should set the send waiting time somewhat longer than the processing time that is required for the host PC to be ready for reception of a response frame after it sends a command frame.

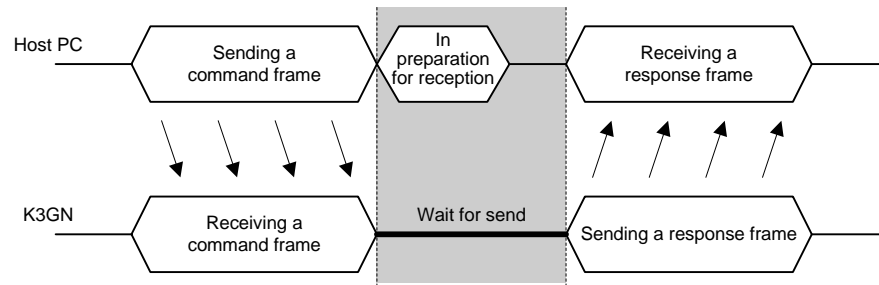

Procedure

A. When the product is at the operation level, press the key and hold it down for at least three seconds to enter the initial setting level.

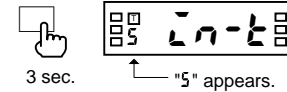

- “5” will appear on the level indicator, indicating the product has entered the initial setting level.

B. Press the key several times until parameter “Pn0w” is displayed, and then enter password “-0169”.

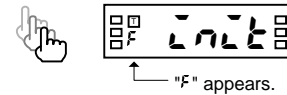

- “F” will appear on the level indicator, indicating the product has entered the advanced-function setting level.
- For details on how to move to the advanced-function setting level, refer to **Section 5.2 Moving among Levels**.

C. Press the key several times until parameter “5dwt” appears on the main indicator.



D. Press the key to display the set value of parameter “5dwt” on the main indicator.

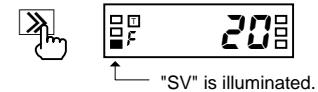

- The current set value of the send waiting time will appear on the main indicator.

E. Press the key again.



- The set value will start blinking, indicating the product is in the change state.

F. Use the and keys to change the set value.



5.25 Changing the Send Waiting Time

G. Press the  key to go to the next parameter.



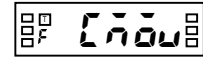

- The change is saved.

H. Press the  key and hold it down for at least one second to return to the initial setting level.





1 sec.

I. Press the  key and hold it down for at least one second to return to the operation level.





1 sec.

CHAPTER

6

FUNCTION DESCRIPTION

This chapter describes available functions of the product.

6.1	Measurement	82
	Analog Input Signal/Pulse Input Signal/ Digital Data from PLC/PC	
6.2	Scaling	84
6.3	Auto-zero/Startup Compensation	86
	Auto-zero/Startup Compensation	
6.4	Average Processing	87
6.5	Event Input/Pulse Input	88
6.6	Process Value Hold	89
6.7	Forced-zero	90
6.8	Comparative Output	91
6.9	Hysteresis	92
6.10	Display Color Change	93

6.1 Measurement

■ Analog Input Signal

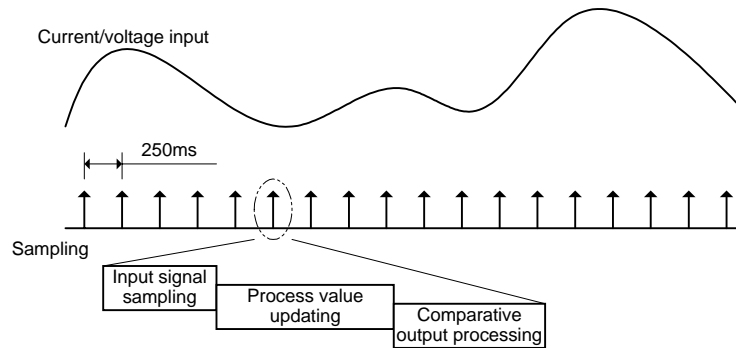

- Input signals are sampled in synchronization with internal timings generated at intervals of 250 ms.
- The input signal is scaled and the process value is updated according to the scaling result. The updated process value is displayed on the main indicator.
- Comparative output is provided based on the process value.
- The process value and comparative output are updated per sampling.

■ Pulse Input Signal

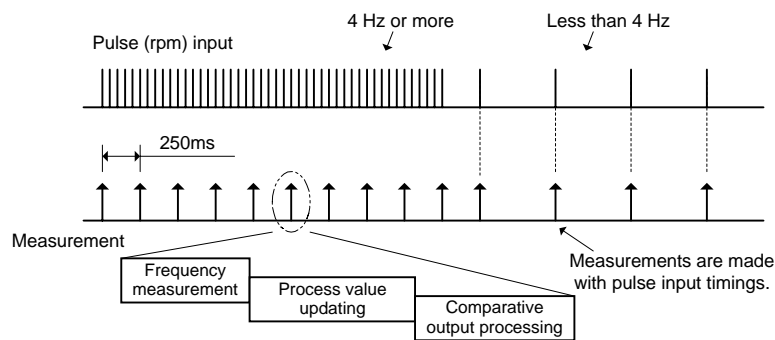

- When the input pulse frequency is 4 Hz or more, it is measured in synchronization with internal timings generated at intervals of 250 ms.
- The input pulse frequency is scaled and the process value is updated according to the scaling result. The updated process value is displayed on the main indicator.
- Comparative output is provided based on the process value.
- The process value and comparative output are updated at intervals of 250 ms.
- When the input pulse frequency is less than 4 Hz, it is measured with pulse input timings; the intervals at which the process value and comparative output are updated lengthen in accordance with the decreasing input pulse frequency.

■ Digital Data from PLC/PC

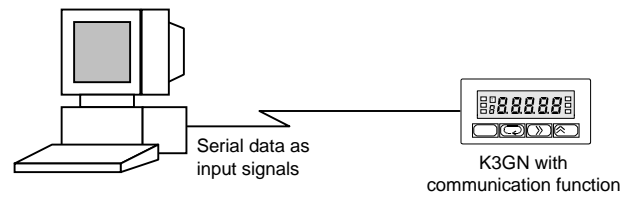

When the product is used as a remote indicator, the host PC not only provides logging of measured data and remote control to the product but also acts as input equipment for the product. The product performs measurement, scaling and comparative output processing.

The product measures serial data as follows.

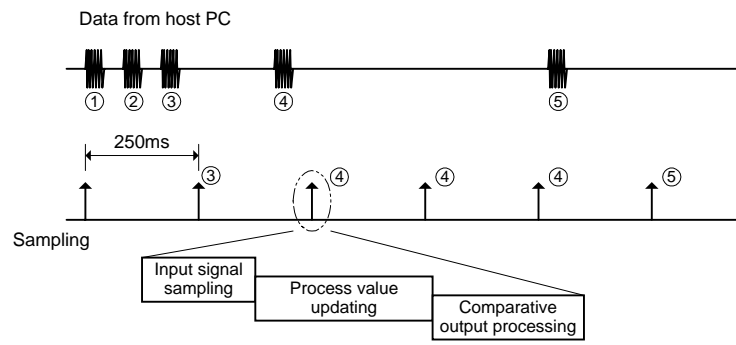

- Data from the host PC is stored with timings of data transmission. When new data is received, old data is replaced with the new one.
- Stored data is fetched as input values in synchronization with internal timings generated at intervals of 250 ms, irrespective of timing signals received from the host PC.
- The input value is scaled and the process value is updated according to the scaling result. The updated process value is displayed on the main indicator.
- Comparative output is provided based on the process value.
- The process value and comparative output are updated with internal timings generated at intervals of 250 ms.

6.2 Scaling

Scaling is to convert sampled input values to process values in sequence using a predetermined scaling formula.

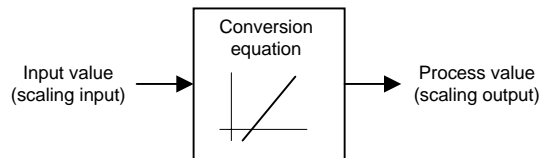

Scaling allows conversion of input values to process values in easy-to-understand notation.

Scaling Formula for Analog Input and Digital Data

The scaling formula for analog input and digital data is as follows.

$$dsp = \frac{DSP2 - DSP1}{INP2 - INP1} inp + \frac{INP1 \cdot DSP2 - INP2 \cdot DSP1}{INP2 - INP1}$$

Where;

- INP1: Input value
- DSP1: Process value corresponding to input value INP1
- INP2: Input value
- DSP2: Process value corresponding to input value INP2
- inp: Input value sampled
- dsp: Process value corresponding to inp

Enter INP1, DSP1, INP2 and DSP2 to specify the scaling factor.

This way of specifying the scaling factor permits flexible scaling; inverse scaling where the process value decreases with the increasing input value is also possible.

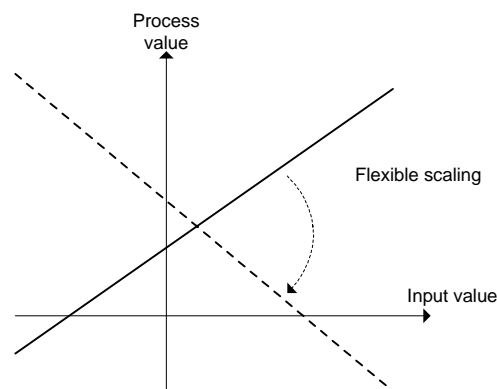

For details on how to specify the scaling factor, refer to **Section 5.11 Specifying the Scaling Factor for Analog Input/Digital Data Display**.

Scaling Formula for Pulse Input

The scaling formula for pulse input is as follows.

$$dsp = \frac{DSP}{INP} inp$$

Where;

INP: Input pulse frequency (Hz)

DSP: Process value corresponding to input pulse frequency INP

inp: Input pulse frequency sampled (Hz)

dsp: Process value corresponding to inp

Enter INP and DSP to specify the scaling factor.

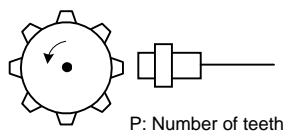
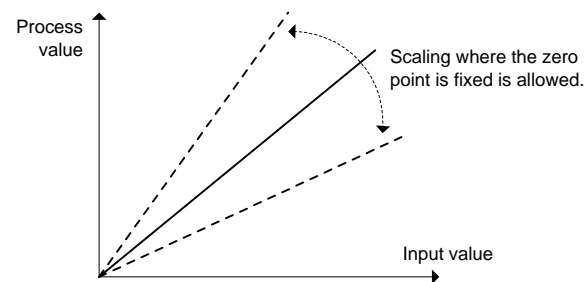

Conversion of the input pulse frequency to the rotational speed involves the following scaling formula.

$$dsp(\text{rpm}) = \frac{60}{P} inp$$

Where;

P: Number of pulses per rotation

inp: Input pulse frequency (Hz)

dsp: Rotational speed (rpm)

TIPS
Unit conversion
rps = rpm/60

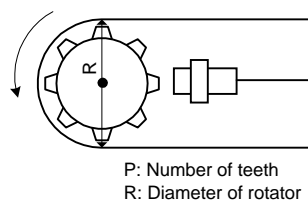

Conversion of the input pulse frequency to the circumferential speed involves the following scaling formula.

$$dsp(\text{m/min}) = \pi \cdot R \cdot \frac{60}{P} inp$$

Where;

π : Circular constant

P: Number of pulses per rotation

R: Diameter of rotator (m)

inp: Input pulse frequency (Hz)

dsp: Circumferential speed (m/min)

TIPS
Unit conversion
m/s = (m/min)/60
mm/s = {(m/min)×1000}/60

6.3 Auto-zero/Startup Compensation

■ Auto-zero

The product has an input-pulse frequency range of 0.05 to 30 Hz or 0.1 to 5 kHz, and hence the maximum interval between pulses is 20 seconds.

This means that the product may provide a lower-limit action signal as late as a maximum of 20 seconds after receiving the last pulse, which results in a poor responsiveness for the lower-limit action.

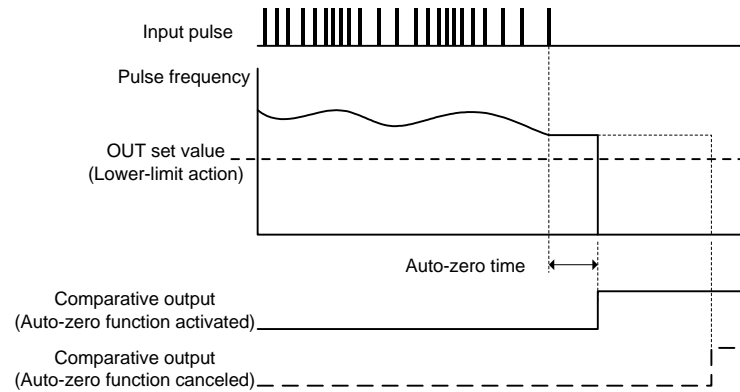

To eliminate such a situation, the product has an **auto-zero** function that shifts the input pulse frequency to zero forcibly when no pulse is received for a predetermined time.

This function improves the product responsiveness for the lower-limit action.

The time between reception of the last pulse and zero-shifting of the input pulse frequency is called the auto-zero time. The auto-zero time can be specified using the “auto-zero time” parameter.

Specify the auto-zero time somewhat longer than the expected longest interval between input pulses.

■ Startup Compensation

The product has a **startup compensation timer** that prevents measurement for a predetermined time after power-on.

This function is useful in keeping the product in wait state until a rotator reaches the steady-state speed.

The time between power-on the product and the start of measurement can be specified using the “startup compensation time” parameter.

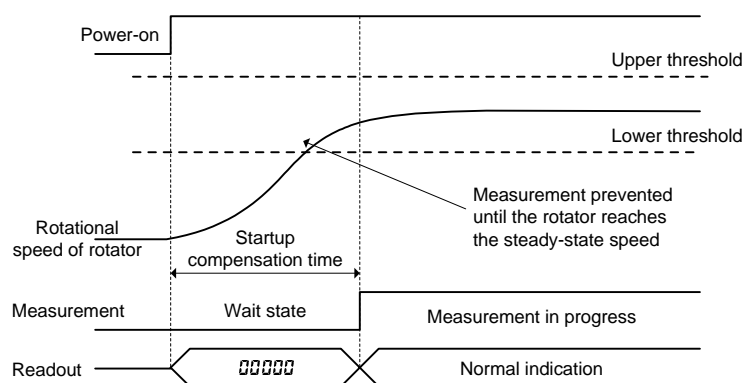

6.4 Average Processing

This function averages a specified number of measurements.
It is useful for preventing readouts from fluctuating due to unstable input.

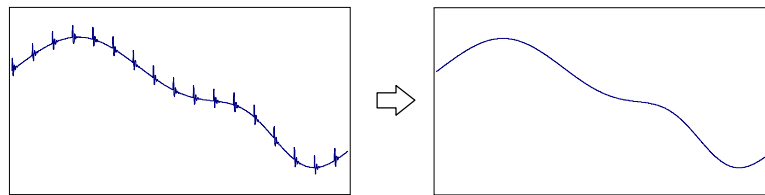

The average processing of the product provides a simple average (an arithmetic mean).

The number of measurements for averaging that can be specified is as follows.

- No average processing (the number of measurements for averaging: 1)
- 2
- 4
- 8

The number of measurements for averaging is the number of times the process value is updated as described in **Section 6.1**.

The following shows the relationship between the number of measurements for averaging and the interval at which the process value and comparative output are updated.

● Analog signal input/Digital data from PC/PLC

Number of measurements for averaging	Update interval
No average processing	250 ms
2	500 ms
4	1 second
8	2 seconds

FUNCTION DESCRIPTION

● Pulse frequency

Number of measurements for averaging	Update interval	
	Input pulse frequency ≥ 4 Hz	Input pulse frequency < 4 Hz
No average processing	250 ms	Every input pulse
2	500 ms	Every 2 input pulses
4	1 second	Every 4 input pulses
8	2 seconds	Every 8 input pulses

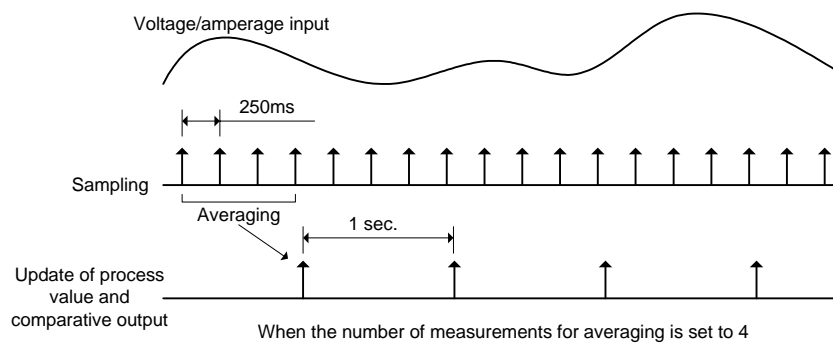

6.5 Event Input/Pulse Input

Terminal ③ acts as the **event input** terminal when the input type is set to "analog" or "remote" and as the **pulse input** terminal when the input type is set to "pulse". The event input terminal can be assigned the task of "process value hold" or "forced-zero". This assignment depends on setting of the "event input" parameter at the advanced-function setting level.

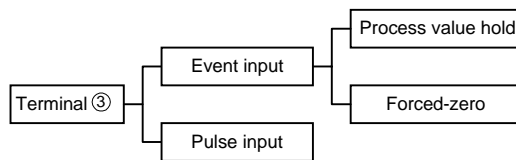

Minimum Pulse Width

The minimum pulse width of ON/OFF signals recognizable to the product varies between the event and pulse inputs.

- For event input

When terminal ③ is used for event input, chattering noise is removed from input signals and therefore devices of contact output type can be connected to the terminal.

The chattering noise removal processing suppresses signal fluctuations that occur within 30 to 40 ms after the input signal turns on or off.

Both ON and OFF pulses must therefore have at least 40 ms in width.

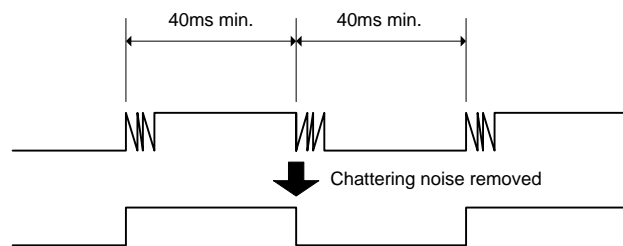

- For pulse input

When terminal ③ is used for pulse input, devices of low-speed contact output type or high-speed transistor output type can be connected to the terminal depending on parameter setting.

When using a device of low-speed contact output type, set the input pulse frequency to "30 Hz". In this case, chattering noise is removed and accordingly both ON and OFF pulses must have at least 15 ms in width.

When using a device of high-speed transistor output type, set the input pulse frequency to "5 kHz". In this case, both ON and OFF pulses must have at least 90 μs in width.

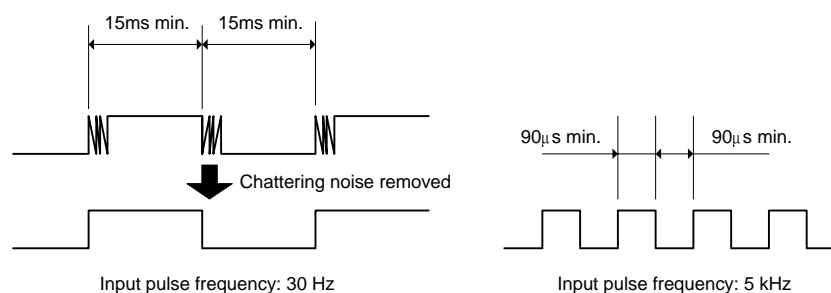

6.6 Process Value Hold

This function detects the process value at the instant when the event input turns on, and holds the value as long as the event input is on.

It can be used to hold the process value detected when a failure occurs.

“Process value hold” takes place via the event input terminal.

The following illustrates the “process value hold” operation.

TIPS

The “process value hold” function is available only when the input type is set to “analog” or “remote” and terminal ③ is assigned the task of “process value hold”.

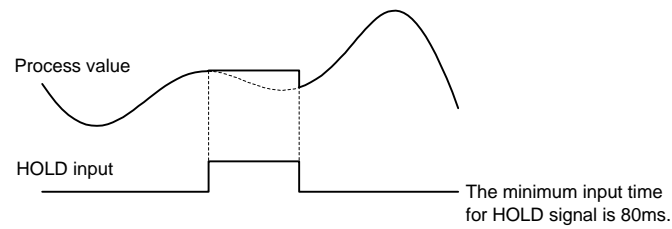

- When the event input (HOLD) turns on, the process value is detected and held.
- If the input value changes, the process value continues to be held as long as the event input is on.
- When the event input (HOLD) turns off, the “process value hold” function is canceled and the display returns to the current value.

6.7 Forced-zero

Note

The forced-zero function is not available when the input type is set to "pulse". Key entry for the forced-zero operation is also ignored.

TIPS

The forced-zero function is available via the event input terminal only when the input type is set to "analog" or "remote" and terminal ③ is assigned the task of "forced-zero execution".

This feature shifts a process value to zero, and can be used to evaluate and display the deviation of a process value from a reference value.

The forced-zero function can be activated by using the  key on the front panel, via the event input terminal, or communications

The following illustrates the forced-zero and forced-zero cancel operation.

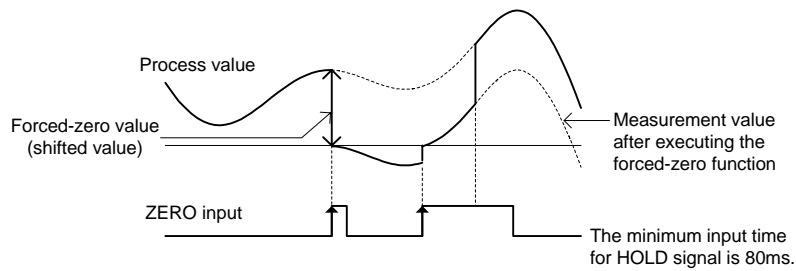

- When ZERO input turns on, the current process value is shifted to zero forcibly.
- Thereafter, measurements are made relative to the zero point.
- When ZERO input turns on while the forced-zero function has been activated, the current process value is further shifted to zero.
- When ZERO input is on for one second, the forced-zero operation is canceled.

Because the forced-zero and forced-zero cancel operation using the  key is stored in EEPROM, the forced-zero state is alive even if the power is turned off and on again.

In contrast, the forced-zero and forced-zero cancel operation via event input terminal is not stored in EEPROM.

If the forced-zero operation is executed via the event input terminal after it is activated by key entry, the forced-zero operation via the event input terminal takes effect.

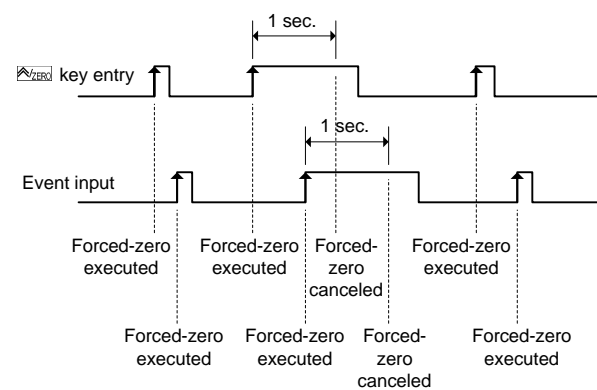

The forced-zero cancel operation is ignored if the forced-zero function has already been deactivated.

6.8 Comparative Output

Comparative outputs 1 and 2 can be produced as three types of action signals: upper-limit action signal, lower-limit action signal, and outside-the-range action signal.

Upper-limit Action

Comparative output turns on when the process value reaches the OUT set value.

Comparative output turns off when the process value decreases to (OUT set value - hysteresis).

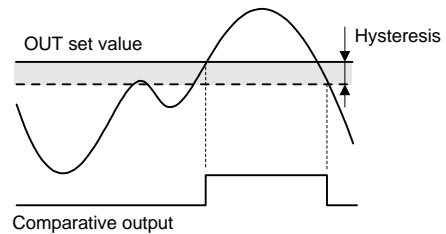

Lower-limit Action

Comparative output turns on when the process value decreases to the OUT set value.

Comparative output turns off when the process value reaches (OUT set value + hysteresis).

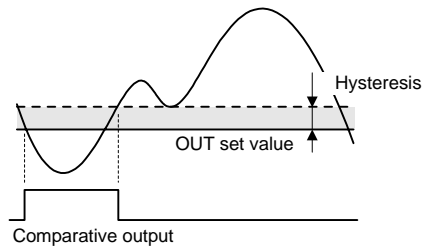

Outside-the-range Action

Comparative output turns on when the process value reaches the OUT upper-limit value or decreases to the OUT lower-limit value.

Comparative output turns off when the process value falls inside the range of (OUT upper-limit value - hysteresis) to (OUT lower-limit value + hysteresis).

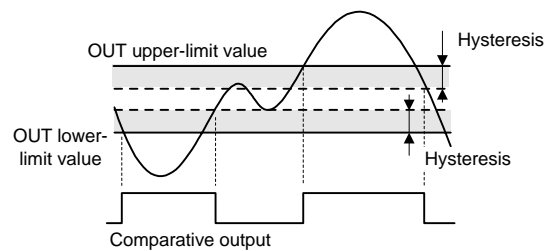

FUNCTION DESCRIPTION

Combinations of comparative outputs 1 and 2 offer the possibility of producing a wide variety of actions including upper-limit + another upper-limit actions, lower-limit + another lower-limit actions, and two-level outside-the-range actions.

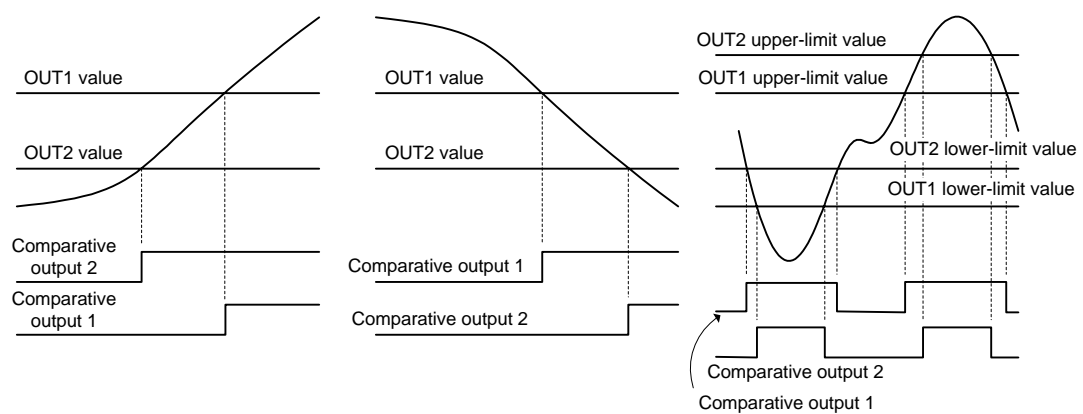

6.9 Hysteresis

In this manual, **hysteresis** refers to a range that is provided above or below an OUT set value in order to avoid comparative output from turning off unless the process value falls outside the range, once the comparative output has turned on at the OUT set value.

Specifying the hysteresis suppresses chattering of comparative output caused by fluctuations of the process value in the vicinity of the OUT set value.

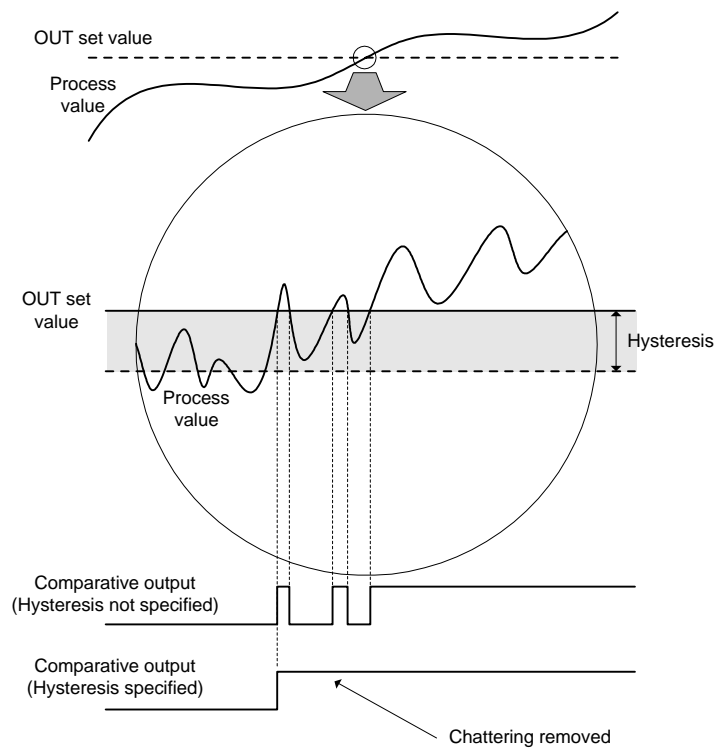

Comparative output ON/OFF conditions are as follows.

- Upper-limit action
 - ON: Process value \geq OUT set value
 - OFF: Process value \leq OUT set value – Hysteresis
- Lower-limit action
 - ON: Process value \leq OUT set value
 - OFF: Process value \geq OUT set value + Hysteresis

Set the hysteresis to a value ranging from 1 to 9999 at the advanced-function setting level.

For the procedure for hysteresis setting, refer to **Section 5.19 Specifying the Hysteresis**.

6.10 Display Color Change

The display color of the main indicator can be changed.

This feature can be used to vary the display color of the gang-mounted products depending on their importance or to give greater prominence to indications on the main indicator of certain products in an emergency.

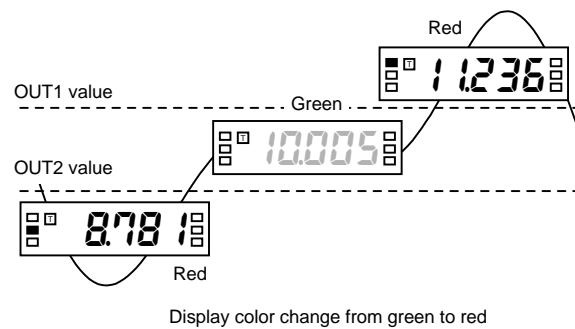

Four display color change options are available.

Green to red: The display color of the main indicator is green when both of comparative outputs 1 and 2 is off, and changes to red when either of the comparative outputs turns on.

Always green: The display color is always green.

Always red: The display color is always red.

Red to green: The display color is red when both of comparative outputs 1 and 2 is off, and changes to green when either of the comparative outputs turns on.

Select one among these options at the advanced-function setting level.

For the procedure for programming of display colors, refer to **Section 5.22 Changing the Display Color**.

CHAPTER

7

COMMUNICATIONS

This chapter describes commands and responses conforming to the CompoWay/F serial communication format and how to control the product by the host PC via communications.

7.1	Communication Protocols	96
	CompoWay/F Communication Protocol/ Communication Specification/Transmission Procedure	
7.2	Data Format Structure	97
	Command Frame/Response Frame	
7.3	Structure of Command/Response Text	99
7.4	Variable Area	100
7.5	Read from Variable Area	101
7.6	Write to Variable Area	102
7.7	Operation Instructions	103
7.8	Setting Areas	104
7.9	Commands and Responses	105
	Read Process Value/Read Status/Read Remote Input Value/ Read OUT Set Value/Write OUT Set Value/Read Parameter/ Write Protect Level Parameter/ Write Parameter (Setting Area 1)/Communication Writing/ Forced-zero Execution/Cancel/ Software Reset/Move to Setting Area 1/ Move to Protect Level/Read Controller Attribute / Read Controller Status/Read Version/Echoback Test	
7.10	Variable Area Map	113
7.11	Communications Control Flow	116
	Communication Reading/ Communication Writing (Setting Area 0)/ Protect Level Parameter Writing/ Parameter Writing (Setting Area 1)/Operation Instruction	
7.12	Programming Example	121
	N88 BASIC/Protocol Macro	

7.1 Communication Protocols

■ CompoWay/F Communication Protocol

TIPS

The program for communications is created on the host PC, and K3GN's parameters are monitored or set from the host PC. In this manual, consequently, an explanation for communications is given from the standpoint of the host PC.

CompoWay/F is an OMRON's standard communication format for general serial communications. It uses a standard frame format as well as FINS commands that have been proven in data exchange between OMRON's programmable logic controllers. The CompoWay/F format facilitates serial communications between components or a PC and components.

FINS (Factory Interface Network Service)

FINS is a protocol for message communications between controllers in OMRON FA networks.

■ Communication Specification

Transmission line connection:	Multipoint
Communications method:	Two-wire, half-duplex
Synchronization method:	Start-stop synchronization
Baud rate:	1,200, 2,400, 4,800, 9,600, or 19,200 bps
Communication code:	ASCII
Word length:	7 or 8 bits
Stop bit length:	1 or 2 bits
Parity check:	Vertical parity - Non, Odd, or Even BCC (block check character) Start-stop synchronization data composition
Flow control:	Non
Interface:	RS-485
Retry function:	Non

■ Transmission Procedure

Communications between the product and the host PC are implemented on a frame-by-frame basis.

When the host PC sends a command frame to the product, the product returns to the host PC a response frame that corresponds to the command frame.

Command and response frames are transmitted as follows.

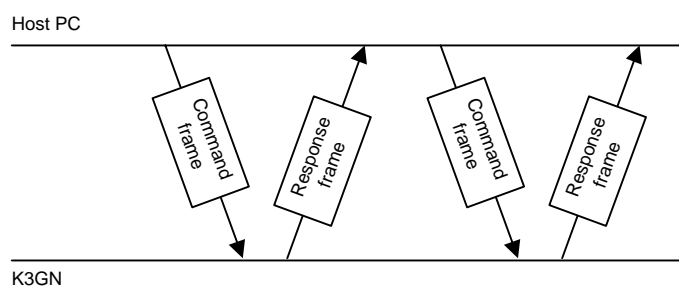

7.2 Data Format Structure

Combinations conforming to the CompoWay/F serial communication format involve transmission of blocks of data that are called **frames**. Those sent from the host PC are command frames and those from the product are response frames. The structure of these frames is shown below.

In the following frame description, suffix H added to a numeric value, as in 02H, means the value is a hexadecimal number. And double quotation marks in which an alphanumeric value is enclosed, as in "00", mean that the value is an ASCII character set.

The number underneath each delimiter in a frame indicates the number of bytes.

■ Command Frame

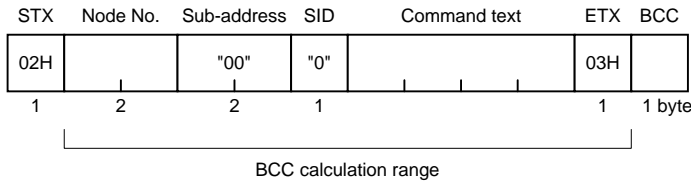

STX	Code indicating the start of a command frame (02H). Be sure to place this code in the first byte of a command frame.
Node No.	Node ID specifying the destination of a command frame. Set this No. to the "unit No." of the product. If you want to broadcast a command, set this No. to "XX". Note that, in this case, no response is given from the products.
Sub-address	Not used for K3GN. Always set the sub-address to "00".
SID (Service ID)	Not used for K3GN. Always set the SID to "0".
Command text	Command text
ETX	Code indicating the end of text (03H)
BCC	Block check character. The result of block check on the BCC calculation range is stored in this field.

COMMUNICATIONS

TIPS

How to determine BCC: BCC is determined by XOR operation, on a byte-by-byte basis, of the values within the range from the Node No. field to the ETX field. The result (36H in the example shown right) is placed in the BCC field.

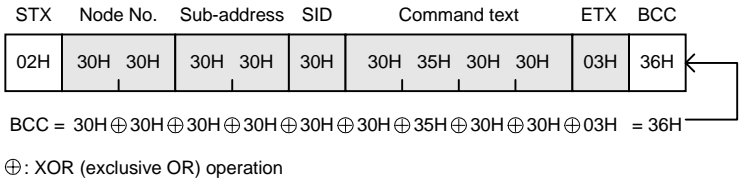

■ Response Frame

STX	Node No.	Sub-address	End code	Response text	ETX	BCC
02H		"00"			03H	
1	2	2	2		1	1 byte

TIPS

The product does not respond to such a command frame that does not end in ETX and BCC characters.

STX	Code indicating the start of a response frame (02H). Be sure to place this code in the first byte of a response frame.
Node No.	The Node No. is set to the value that was specified in the corresponding command frame. The unit No. of the product that returns the response is set in this field.
Sub-address	Not used for K3GN. This field is always set to "00".
End code	This field contains the result of execution of the corresponding command frame.
Response text	Response text
ETX	Code indicating the end of text (03H)
BCC	Block check character. The result of block check on the BCC calculation range is stored in this field.

● End code

End code	Code name	Description
"11"	Framing error	A framing error (the stop bits represented 0) occurred in one of the characters received.
"10"	Parity error	The sum of the bits of "1" in the received data does not match the specified number.
"12"	Overrun error	An attempt was made to transfer new data when the buffer was full.
"18"	Frame length error	The size of the received frame exceeded the specified number of bytes.
"13"	BCC error	The received BCC was different from the calculated BCC.
"16"	Sub-address error	<ul style="list-style-type: none"> No sub-address, SID, and command text. This error is not covered by the echoback test. The size of the sub-address was less than two characters, and no SID and command text were found.
"14"	Format error	<ul style="list-style-type: none"> The command text contains characters other than "0 thru "9" and "A" thru "F". No SID and command text. MRC and SRC in the command text were not included in the command text..
"0F"	FINS command error	The specified FINS command could not be executed. (The FINS response code may provide a suggestion about the reason of the failure in command execution.)
"00"	Normal completion	The command was successfully executed.

7.3 Structure of Command/Response Text

The command/response text constitutes the main body of a command/response frame.

The structure of the command/response text is as follows.

Command Text The command text consists of MRC (Main Request Code) and SRC (Sub Request Code) followed by the required data.

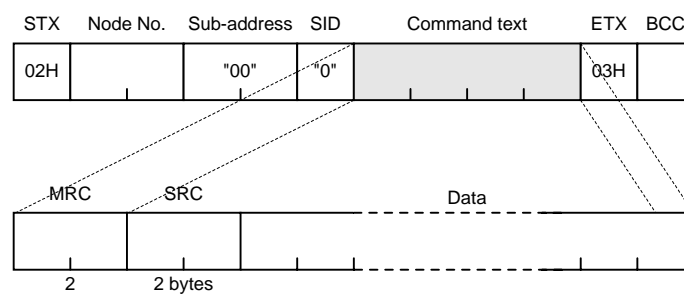

Response Text The response text consists of MRC and SRC followed by MRES (Main Response Code) and SRES (Sub Response Code) and the required data.

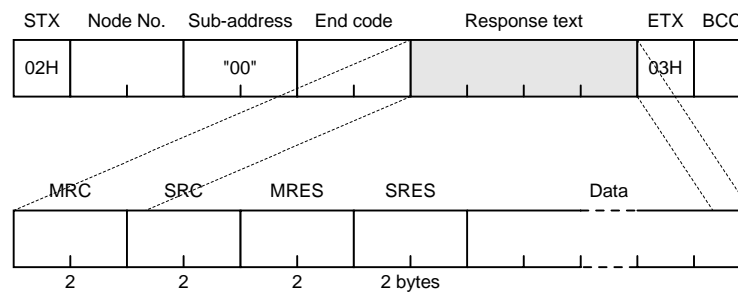

If the product fails to execute a specified command, it generates a response consisting of MRC/SRC and MRES and SRES only.

- List of services

MRC	SRC	Service name	Description
"01"	"01"	Read from variable area	This service reads from the variable area.
"01"	"02"	Write to variable area	This service writes to the variable area.
"05"	"03"	Read controller attribute	This service reads the model No. and the communications buffer size.
"06"	"01"	Read controller status	This service reads the run status of the controller.
"08"	"01"	Echoback test	This service carries out the echoback test.
"30"	"05"	Operation instructions	This service carries out forced-zero (cancel) operation, etc.

7.4 Variable Area

A section of memory in the product that holds data to be transmitted is called the **variable area**.

The variable area is used for reading of current process values or reading/writing of various parameters.

In contrast, the variable area is not used for operation instructions or reading of controller attributes.

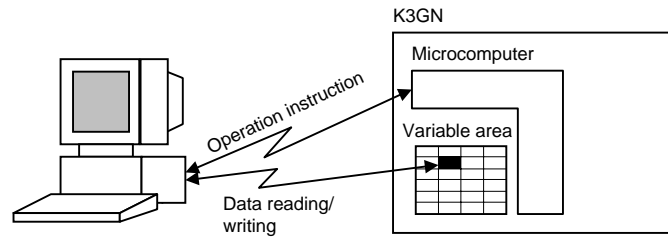

To specify the position of a variable in the variable area, use a **variable type** and an **address**.

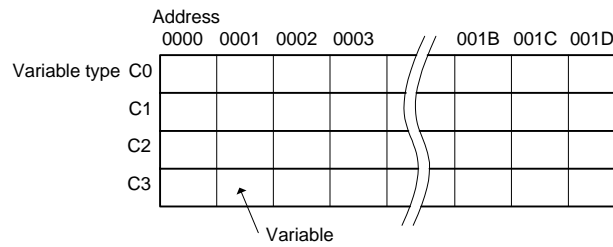

Append to each variable type an access-size-based address that is expressed in 2-byte hexadecimal code

A variable has an eight-digit value in hexadecimal. A negative variable is expressed in two's complement. When the current value of a variable is read as **105.0** on the main indicator of the product, for example, its hexadecimal notation is 0000041AH (the decimal point is ignored; 105.0 → 1050 → 0000041AH), and the variable is read in this form.

The variable area is mapped as follows. The variable type is converted to a 2-byte ASCII code and loaded to the frame. Available variable types are also shown below.

	0000	0001	0002	0003	0004	0005	0006	0007	0008	0009	000A	000B	000C	000D	000E	000F	0010	0011	0012	0013	0014	0015	0016	0017	0018	0019	001A	001B	001C	001D
C0	Process value, etc.										Not used																			
C1	Protect level															Not used														
C2	Operation level																Not used													
C3	Initial setting level								Communication setting level				Advanced-function setting level																	

Variable type C0: Read-only data including process values and status

Variable type C1: Protect level parameters

Variable type C2: Operation level parameters (OUT set values and remote input values)

Variable type C3: Initial setting, communication setting, and advanced-function setting level parameters

7.5 Read from Variable Area

This service reads data from the variable areas.

Command

Command text

MRC	SRC	Variable type	Read start address	Bit position	No. of elements
"01"	"01"			"00"	
2	2	2	4	2	4 bytes

Item	Description
MRC/SRC	Set these items to "01"/"01" ("Read from Variable Area" service).
Variable type	Set this item to one among "C0" thru "C3".
Read start address	Specify the read start address at this field.
Bit position	Not used for K3GN. Always set this item to "00".
No. of elements	Set this item to the quantity of variables that are to be read (up to 10).

Response

Response text

MRC	SRC	Response code (MRES/SRES)	Data to be read
"01"	"01"		
2	2	4	(No. of elements x 8) bytes

Item	Description
MRC/SRC	This field contains the same value ("01"/"01") as specified in the command text.
Response code	This field contains the result of execution of the command.
Data to be read	This field contains the data that is read and to be read.

Response codes

Response code	Code name	Description
"1001"	Command length over	The command is too long.
"1002"	Command length short	The command is too short.
"1101"	Area type error	The specified variable type is invalid.
"1103"	Start address out-of-range error	The specified start address is outside the valid range.
"110B"	Response length over	The No. of elements exceeds 10.
"1100"	Parameter error	The bit position is set to a value other than "00".
"2203"	Operation error	EEPROM error
"0000"	Normal completion	The command was successfully executed.

7.6 Write to Variable Area

This service writes data to the variable area.

Command

Command text

MRC	SRC	Variable type	Write start address	Bit position	No. of elements	Data to be written
"01"	"02"			"00"		
2	2	2	4	2	4 bytes	(No. of elements x 8) bytes

Item	Description
MRC/SRC	Set these items to "01"/"02" ("Write to Variable Area" service).
Area type	Set this item to one among "C1" thru "C3".
Write start address	Specify the write start address at this field.
Bit position	Not used for K3GN. Always set this item to "00".
No. of elements	Set this item to the quantity of variables that are to be written (up to 10).
Data to be written	Place the desired data in this field.

Response

Response text

MRC	SRC	Response code (MRES/SRES)
"01"	"02"	
2	2	4

Item	Description
MRC/SRC	This field contains the same value ("01"/"02") as specified in the command text.
Response code	This field contains the result of execution of the command.

Response codes

Response code	Code name	Description
"1002"	Command length short	The command is too short.
"1101"	Area type error	The specified variable type is invalid.
"1103"	Start address error	The specified start address is outside the valid range.
"1104"	End address error	The specified start address is outside the valid range.
"1003"	Data quantity mismatch error	A mismatch between the No. of elements and the quantity of variables occurs.
"1100"	Parameter error	<ul style="list-style-type: none"> The bit position is set to a value other than "00". The value of data to be written is outside the valid range.
"3003"	Read only error	An attempt is made to write data to an address of variable type C0.
"2203"	Operation error	<ul style="list-style-type: none"> Communication writing is disabled. An attempt is made to write data from setting area 0 to setting area 1. An attempt is made to write a protect level parameter at a level other than protect level. An attempt is made to write data to an address of variable type C3 at the calibration level. An error occurs in EEPROM.
"0000"	Normal completion	The command was successfully executed.

7.7 Operation Instructions

To issue an operation instruction to the product, set the items in the command text as follows.

Command

Command text

MRC	SRC	Instruction Related code information	
"30"	"05"		
2	2	2	2 bytes

Item	Description
MRC/SRC	Set these item to "30"/"05" (Operation Instruction service).
Instruction code	Place an instruction code in this field.
Related information	Place information related to the operation instruction in this field.

Instruction codes

Instruction code	Operation	Related information
"00"	Communication writing	"00": Off (disable) "01": On (enable)
"03"	Forced-forced-zero execution/ Forced-zero cancel	"00": Cancel "01": Execute
"06"	Software reset	"00"
"07"	Move to setting area 1	"00"
"08"	Move to protect level	"00"

Response

Response text

MRC	SRC	Response code (MRES/SRES)
"30"	"05"	
2	2	4 bytes

Item	Description
MRC/SRC	This field contains the same value ("30"/"05") as specified in the command text.
Response code	This field contains the result of execution of the command.

Response codes

Response code	Code name	Description
"1001"	Command length over	The command is too long.
"1002"	Command length short	The command is too short.
"1100"	Parameter error	The instruction code or related information is invalid.
"2203"	Operation error	<ul style="list-style-type: none"> Communication writing is disabled. The specified operation cannot be executed. For details, refer to Section 7.9 Commands and Responses . <ul style="list-style-type: none"> An error occurs in EEPROM.
"0000"	Normal completion	The command was successfully executed.

7.8 Setting Areas

The K3GN series of products can assume two states that are referred to as **setting area 0** and **setting area 1** in this manual.

In setting area 0, the product is carrying out a measurement.

In this state, you can therefore perform such operations that are permitted only during measuring, or that cause no trouble even if a measurement is in progress. These operations include “process value reading”, “parameter writing” and “forced-zero execution”.

On the contrary, this state prohibits such operations that exert an effect on measurement in progress, including “parameter writing at the initial setting level” (parameter reading is always allowed).

In setting area 1, measurement is suspended.

In this state, you can therefore perform such operations that are not allowed in setting area 0. These operations include “parameter writing at the initial setting, communication setting, and advanced-function setting levels”.

At power-on, the product is in setting area 0. To move to setting area 1, use the “move-to-setting area 1” instruction. To return to setting area 0, power the product off and on again, or use the “software reset” instruction.

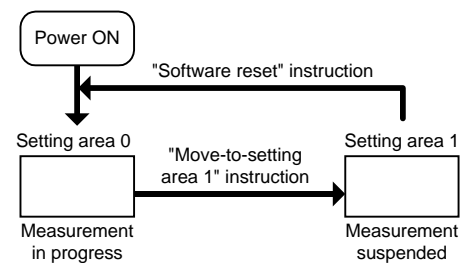

The figure on the right shows the setting areas and the levels contained in each setting area.

A transition to the initial setting level by key operation implies a transition from setting area 0 to setting area 1. This enables the host PC to operate the product in setting area 1.

A transition to setting area 1 by remote control from the host PC causes the level indicator on the front panel to indicate the product is at the initial setting level. To return to the operation level, use the key.

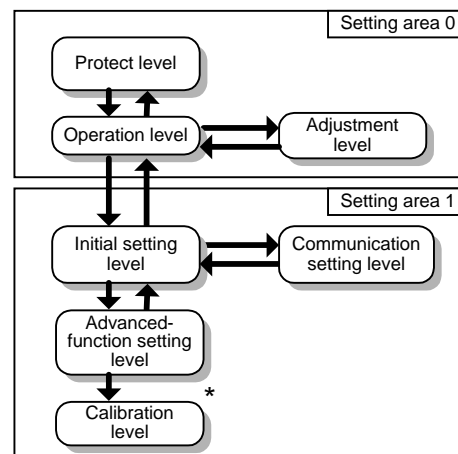

* At the calibration level, the product refuses control from the host PC.

7.9 Commands and Responses

Various commands for application layer are available for implementing the services, such as “variable area read/write” and “operation instructions”, offered by the CompoWay/F communication format.

This section contains description of the available commands for the application layer.

■ Read Process Value

Command	MRC	SRC	Variable	Address	Bit	No. of elements
			type		position	
	"01"	"01"	"C0"	"0001"	"00"	"0001"

This command reads the current process value.

Use this command when the product is in setting area 0.

(If the product is in setting area 1 when receiving the command, it returns a response with the “unknown” current value data).

Response	MRC	SRC	Response code	Data
			"01"	"01"

Response code: The code shown above represents normal completion. For details on the response code, refer to **Section 7.5 Read from Variable Area**.

■ Read Status

Command	MRC	SRC	Variable	Address	Bit	No. of elements
			type		position	
	"01"	"01"	"C0"	"0002"	"00"	"0001"

This command reads the status of comparative outputs or the like.

Use this command when the product is in setting area 0.

(If the product is in setting area 1 when receiving the command, it returns a response with the “unknown” status data).

Response	MRC	SRC	Response code	Data
			"01"	"01"

For details on the status, refer to **Section 7.10 Variable Area Map**.

Response code: The code shown above represents normal completion. For details on the response code, refer to **Section 7.5 Read from Variable Area**.

■ Read Remote Input Value

Command

MRC	SRC	Variable type	Address	Bit position	No. of elements	Data
"01"	"02"	"C2"	"0000"	"00"	"0001"	Remote input value

This command supplies an input value to the product that is used as a digital data display for PLC/PC.

Use this command when the product is in setting area 0.
(If the product is in setting area 1 when receiving the command, no change occurs on the main indicator as measurement is suspended).

Before issuing the command, use an operation instruction to enable “communication writing”.

Response

MRC	SRC	Response code
"01"	"02"	"0000"

Response code: The code shown above represents normal completion. For details on the response code, refer to **Section 7.6 Write to Variable Area**.

■ Read OUT Set Value

Command

MRC	SRC	Variable type	Address	Bit position	No. of elements
"01"	"01"	"C2"		"00"	"0001"

Address	Parameter
"0001"	OUT1 value
"0002"	OUT1 upper-limit value
"0003"	OUT1 lower-limit value
"0004"	OUT2 value
"0005"	OUT2 upper-limit value
"0006"	OUT2 lower-limit value

This command reads an OUT set value.

(Even if the type of the OUT set value is “upper” or “lower”, OUT upper and lower-limit values can be read. Even if the type of the OUT set value is “upper/lower”, an OUT set value can be read).

Response

MRC	SRC	Response code	Data
"01"	"01"	"0000"	Threshold

Response code: The code shown above represents normal completion. For details on the response code, refer to **Section 7.5 Read from Variable Area**.

Write OUT Set Value

Command

MRC	SRC	Address	No. of elements	Data
"01"	"02"	"C2"	"00"	"0001"
				OUT set value

Address	Parameter
"0001"	OUT1 value
"0002"	OUT1 upper-limit value
"0003"	OUT1 lower-limit value
"0004"	OUT2 value
"0005"	OUT2 upper-limit value
"0006"	OUT2 lower-limit value

This command writes an OUT set value.

It can be used when the product is in either setting area 0 or 1.

(Even if the type of the OUT set value is “upper” or “lower”, OUT upper and lower-limit values can be written. Doing so exerts no effect on comparative output. Likewise, even if the type of the OUT set value is “upper/lower”, an OUT set value can be written).

If you want to write both OUT1 and OUT2 values at a time, use block access to the variable area. For details, refer to the tip shown in **Section 7.10 Variable Area Map**.

Before issuing the command, use an operation instruction to enable “communication writing”.

Response

MRC	SRC	Response code
"01"	"02"	"0000"

Response code: The code shown above represents normal completion. For details on the response code, refer to **Section 7.6 Write to Variable Area**.

Read Parameter

Command

MRC	SRC	Variable type	Address	Bit position	No. of elements
"01"	"01"			"00"	"0001"

Variable type	Address	Parameter
"C1"	"0000" to "0003"	Protect level parameters
"C3"	"0000" to "000B"	Initial setting level parameters
	"000C" to "0010"	Communication setting level parameters
	"0011" to "001D"	Advanced-function setting level parameters

This command reads a parameter.

For details on how to specify the variable type and the address, refer to **Section 7.10 Variable Area Map**.

This command can be used when the product is in either setting area 0 or 1.

(“Analog range”, “input pulse frequency”, “scaling input values 1 and 2”, “scaling display values 1 and 2”, “scaling input value”, and “scaling display value” can be read, irrespective of input type setting).

Response

MRC	SRC	Response code	Data
"01"	"01"	"0000"	Parameter

Response code: The code shown above represents normal completion. For details on the response code, refer to **Section 7.5 Read from Variable Area**.

■ Write Protect Level Parameter

Command

MRC	SRC	Variable type	Address	Bit position	No. of elements	Data
"01"	"02"	"C1"		"00"	"0001"	Protect level parameter

Address	Parameter
"0000"	Operation/adjustment lockouts
"0001"	Initial setting/communication lockouts
"0002"	Setting change lockout
"0003"	Forced-zero lockout

This command writes a protect level parameter.

Use this command when the product is in setting area 0. If the product is in setting area 1 when receiving the command, it returns an error.

Before issuing the command, use operation instructions to enable “writing” and to enter the protect level.

Response

MRC	SRC	Response code
"01"	"02"	"0000"

Response code: The code shown above represents normal completion. For details on the response code, refer to **Section 7.6 Write to Variable Area**.

■ Write Parameter (Setting Area 1)

Command

MRC	SRC	Variable type	Address	Bit position	No. of elements	Data
"01"	"02"	"C3"		"00"	"0001"	Parameter (setting area 1)

Address	Parameter
"0000" to "000B"	Initial setting level parameters
"000C" to "0010"	Communication setting level parameters
"0011" to "001D"	Advanced-function setting level parameters

This command writes an initial setting level parameter, a communication setting level parameter, or an advanced-function setting level parameter.

For details on addressing, refer to **Section 7.10 Variable Area Map**.

Use this command when the product is in setting area 1. If the product is in setting area 0 when receiving the command, it returns an error.

Before issuing the command, use operation instructions to enable “communication writing” and to enter setting area 1.

Response

MRC	SRC	Response code
"01"	"02"	"0000"

Response code: The code shown above represents normal completion. For details on the response code, refer to **Section 7.6 Write to Variable Area**.

■ Communication Writing

Command

MRC	SRC	Instruction code	Related information
"30"	"05"	"00"	

Related information	Description
"00"	Communication writing disable
"01"	Communication writing enable

This command enables/disables communication writing.

It rewrites the value of the adjustment level parameter “communication writing”.

If communication writing is disabled, operation instructions for parameter rewriting, forced-zero execution/forced-zero cancel and the like are rejected.

This command can be used when the product is in either setting area 0 or 1.

Response

MRC	SRC	Response code
"30"	"05"	"0000"

Response code: The code shown above represents normal completion. For details on the response code, refer to **Section 7.7 Operation Instructions**.

■ Forced-zero Execution/Cancel

Command

MRC	SRC	Instruction code	Related information
"30"	"05"	"03"	

Forced-zero	Description
"00"	Forced-zero cancel
"01"	Forced-forced-zero execution

This command executes/cancels the forced-zero operation.

Use this command when the product is in setting area 0. If product is in setting area 1 when receiving the command, it returns an error.

If the product has no measured value, suffers input anomalies, or encounters a “display range over” error when receiving the command, it returns an error. If the event input is used for “process value hold” when receiving the command, it also returns an error.

Before issuing the command, use an operation instruction to enable “communication writing”.

Response

MRC	SRC	Response code
"30"	"05"	"0000"

Response code: The code shown above represents normal completion. For details on the response code, refer to **Section 7.7 Operation Instructions**.

■ **Software Reset**

Command

MRC	SRC	Instruction code	Related information
"30"	"05"	"06"	"00"

This command triggers a software reset, which returns the product to its initial state when it was powered on.

It can be used when the product is in either setting area 0 or 1.

Before issuing the command, use an operation instruction to enable “communication writing”.

Response

(Non)

The software reset command does not require the product to return a response.

■ **Move to Setting Area 1**

Command

MRC	SRC	Instruction code	Related information
"30"	"05"	"07"	"00"

This command provides a transition of the product to setting area 1.

Use this command in setting area 0. If the product is in setting area 1 when receiving the command, the command is ignored.

If the set value of the “initial setting/communication lockouts” parameter is 2 indicating “move to initial setting level” and “move to communication setting level” are disabled (refer to **Section 5.7 Key Protect Setting**) when the product receives the command, the product returns an error.

Before issuing this command, use an operation instruction to enable “communication writing”.

Response

MRC	SRC	Response code
"30"	"05"	"0000"

Response code: The code shown above represents normal completion. For details on the response code, refer to **Section 7.7 Operation Instructions**.

■ **Move to Protect Level**

Command

MRC	SRC	Instruction code	Related information
"30"	"05"	"08"	"00"

This command moves the product to the protect level.

Use this command when the product is in setting area 0. If the product is in setting area 1 when receiving the command, it returns an error.

Before issuing the command, use an operation instruction to enable “communication writing”.

Response

MRC	SRC	Response code
"30"	"05"	"0000"

Response code: The code shown above represents normal completion. For details on the response code, refer to **Section 7.7 Operation Instructions**.

■ Read Controller Attribute

Command

MRC	SRC
"05"	"03"

This command reads the model name and communication buffer size of the product.

For addressing, refer to **Section 7.10 Variable Area Map**.

The command can be used, irrespective of what state the product is in.

Response

MRC	SRC	Response code	Model name	Buffer size
"05"	"03"			"0068"

Model name	Buffer size	Input type	Output type	No. of contacts	Optional feature
"K3GN-NDC"	48 x 24	NPN transistor	Relay	2	Communication
"K3GN-PDC"	48 x 24	PNP transistor	Relay	2	Communication
"K3GN-NDT1"	48 x 24	NPN transistor	NPN transistor	3	Communication
"K3GN-PDT2"	48 x 24	PNP transistor	PNP transistor	3	Communication

The model name is expressed in 10-byte ASCII code. If the model name length is less than 10 bytes, blanks are used for padding in the model name field.

A fixed value of "0068H" (104 bytes) in buffer size is returned.

Response code

Response code	Error name	Description
"1001"	Command length over	The command is too long.
"2203"	Operation error	An error occurs in EEPROM.
"0000"	Normal completion	The command is successfully executed.

■ Read Controller Status

Command

MRC	SRC
"06"	"01"

This command reads the operation status of the product.

The command can be used, irrespective of what state the product is in.

Response

MRC	SRC	Response code	Operation status	Related information
"06"	"01"			

Operation status	Description
"00"	Measurement is in progress normally.
"01"	<ul style="list-style-type: none"> Measurement is suspended. The product has no measured value, suffers input anomalies, or encounters a "display range over" error.

Related information

7	6	5	4	3	2	1	0	Bit position
0	0	0	0	0				

Status	Value of bit	
	0	1
No measured value	Not detected	Detected
Display range over	Not detected	Detected
Input anomaly	Not detected	Detected

If the product is in setting area 1 when receiving the command, it returns a response with the "unknown" related information.

Response code

Response code	Error name	Description
"1001"	Command length over	The command is too long.
"2203"	Operation error	An error occurs in EEPROM.
"0000"	Normal completion	The command is successfully executed.

■ Read Version

Command

MRC	SRC	Variable type	Address	Bit position	No. of elements
"01"	"01"	"C0"	"0000"	"00"	"0001"

This command reads the product software version.
The command can be used, irrespective of the state of the product.

Response

MRC	SRC	Response code	Data
"01"	"01"	"0000"	Version No.

Response code: The code shown above represents normal completion. For details on the response code, refer to **Section 7.5 Read from Variable Area**.

■ Echoback Test

Command

MRC	SRC	Data to be tested
"08"	"01"	0 to 87 bytes

This command performs an echoback test.
The command can be used, irrespective of the state of the product.
Data to be checked must not exceed communication data in length.

Communication data length	Description
7 bits	20H to 7EH converted to ASCII code
8 bits	20H to 7EH or A1H to FEH converted to ASCII code

Response

MRC	SRC	Response code	Data to be tested
"08"	"01"		0 to 87 bytes

Response code

Response code	Error name	Description
"1001"	Command length over	The command is too long.
"2203"	Operation error	An error occurs in EEPROM.
"0000"	Normal completion	The command is successfully executed.

7.10 Variable Area Map

The variable area of the product is mapped in terms of variable types and addresses as described below.

Variable type C0: Read-only data including process values and status

Variable type C1: Protect level parameters

Variable type C2: Operation level parameters (OUT set values and remote input values)

Variable type C3: Initial setting, communication setting, and advanced-function setting level parameters

The address and parameter assignments to each variable type are shown below.

Variable type	Address	Parameter	Meaning of set value/Valid range/Description
C0	0000	Version	00000100H
	0001	Current value	FFFFB1E1H to 0001869FH (–19999 to 99999): Valid 0001869FH (99999): Input anomalous/outside the display range upper limit FFFFB1E1H (–19999): Input anomalous/outside the display range lower limit
	0002	Status	Refer to the figure below.

Status description

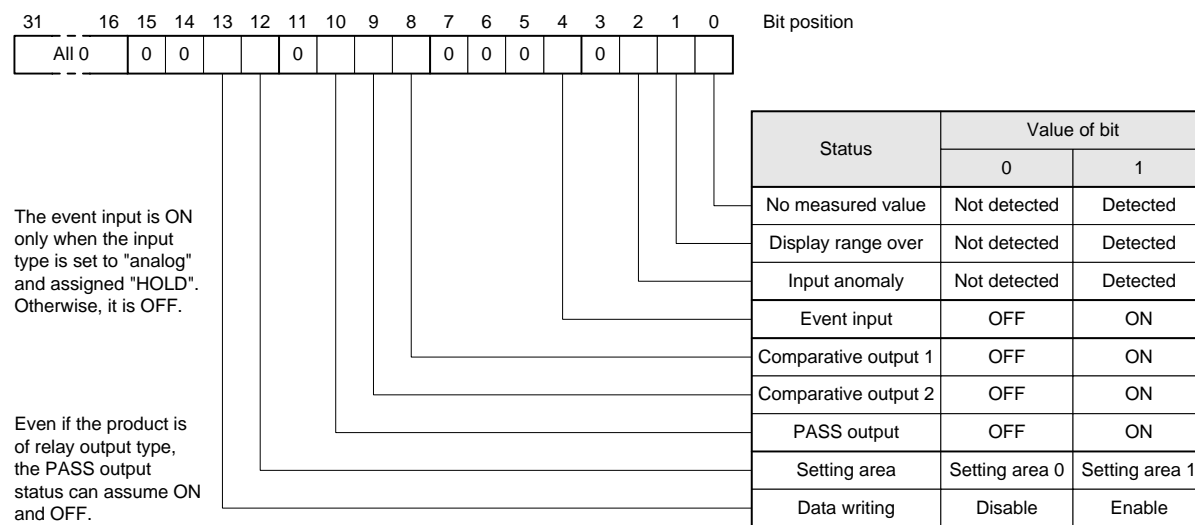

Variable type	Address	Parameter	Meaning of set value/Valid range/Description
C1	0000	Operation/adjustment lockouts	00000000H (0): No restriction at the operation/adjustment levels 00000001H (1): "Move to adjustment level" is disabled. 00000002H (2): Only the process value can be displayed. Access via communications is enabled, irrespective of the value of this parameter.
	0001	Initial setting/communication lockouts	00000000H (0): "Move to initial setting/communication setting/advanced-function setting levels" is enabled. 00000001H (1): "Move to advanced-function setting level" is disabled. 00000002H (2): "Move to initial setting/communication setting levels" is disabled. Access via communications is enabled, irrespective of the value of this parameter.
	0002	Setting change lockout	00000000H (0): OFF: A parameter change by key operation is enabled. 00000001H (1): ON: A parameter change by key operation is disabled. Communication writing is enabled, irrespective of the value of this parameter.
	0003	Forced-zero lockout	00000000H (0): OFF: Forced-zero execution/forced-zero cancel is enabled. 00000001H (1): ON: Forced-zero execution/forced-zero cancel is disabled. Communication writing is enabled, irrespective of the value of this parameter.
C2	0000	Remote input value	FFFFB1E1H to 0001869FH (-19999 to 99999) An input value is written to this variable when the product is used as a digital data display for PLC/PC.
	0001	OUT1 value	FFFFB1E1H to 0001869FH (-19999 to 99999)
	0002	OUT1 upper-limit value	FFFFB1E1H to 0001869FH (-19999 to 99999)
	0003	OUT1 lower-limit value	FFFFB1E1H to 0001869FH (-19999 to 99999)
	0004	OUT2 value	FFFFB1E1H to 0001869FH (-19999 to 99999)
	0005	OUT2 upper-limit value	FFFFB1E1H to 0001869FH (-19999 to 99999)
	0006	OUT2 lower-limit value	FFFFB1E1H to 0001869FH (-19999 to 99999)

Variable type	Address	Parameter	Meaning of set value/Valid range/Description
C3	0000	Input type	00000000H (0): Analog 00000001H (1): Pulse 00000002H (2): Remote
	0001	Analog range	00000000H (0): 4 to 20 mA/0 to 20 mA 00000001H (1): 1 to 5 V/0 to 5 V 00000002H (2): ±5 V 00000003H (3): ±10 V
	0002	Input pulse frequency	00000000H (0): 30 Hz 00000001H (1): 5 kHz
	0003	Scaling input value 1	FFFFB1E1H to 0001869FH (-19999 to 99999)
	0004	Scaling display value 1	FFFFB1E1H to 0001869FH (-19999 to 99999)
	0005	Scaling input value 2	FFFFB1E1H to 0001869FH (-19999 to 99999)
	0006	Scaling display value 2	FFFFB1E1H to 0001869FH (-19999 to 99999)
	0007	Scaling input value	FFFFB1E1H to 0001869FH (-19999 to 99999): When the input type is set to "pulse"
0008	Scaling display value	FFFFB1E1H to 0001869FH (-19999 to 99999): When the input type is set to "pulse"	

Variable type	Address	Parameter	Meaning of set value/Valid range/Description
C3	0009	Decimal point position	00000000H (0): 000000 00000001H (1): 00000.0 00000002H (2): 000.00 00000003H (3): 00.000 00000004H (4): 0.0000
	000A	OUT1 type	00000000H (0): Upper-limit action 00000001H (1): Lower-limit action 00000002H (2): Outside-the-range action
	000B	OUT2 type	00000000H (0): Upper-limit action 00000001H (1): Lower-limit action 00000002H (2): Outside-the-range action
	000C	Communication unit No.	00000000H ~ 00000063H (0 ~ 99)
	000D	Baud rate	00000000H (0): 1.2 kbps 00000001H (1): 2.4 kbps 00000002H (2): 4.8 kbps 00000003H (3): 9.6 kbps 00000004H (4): 19.2 kbps
	000E	Word length	00000000H (0): 7 bits 00000001H (1): 8 bits
	000F	Stop bit length	00000000H (0): 1 bit 00000001H (1): 2 bits
	0010	Parity bits	00000000H (0): Non 00000001H (1): Even 00000002H (2): Odd
	0011	No. of measurements for averaging	00000000H (0): OFF 00000001H (1): 2 00000002H (2): 4 00000003H (3): 8
	0012	Event input function	00000000H (0): HOLD 00000001H (1): ZERO
	0013	OUT1 hysteresis	00000000H to 0000270FH (0 to 9999)
	0014	OUT2 hysteresis	00000000H to 0000270FH (0 to 9999)
	0015	Auto-zero time	00000000H to 000000C7H (0.0 to 19.9)
	0016	Startup compensation time	00000000H to 000003E7H (0.0 to 99.9)
	0017 to 0019	(Not assigned)	00000000H (0)
	001A	Display color change	00000000H (0): Green to red 00000001H (1): Always green 00000002H (2): Red to green 00000003H (3): Always red
	001B	Display auto-return time	00000000H to 00000063H (0 to 99)
	001C	Move-to-protect-level time	00000000H to 00000013H (0 to 19)
001D	Send waiting time	00000000H to 00000063H (0 to 99)	

COMMUNICATIONS

TIPS

Block access to the variable area

A number of contiguously addressed variables of the same type in the variable area can be accessed at a time. For example, you can read the current value and the status simultaneously by setting the read start address to the address of the current value and setting the No. of elements to 2.

Such an access method is called "block access".

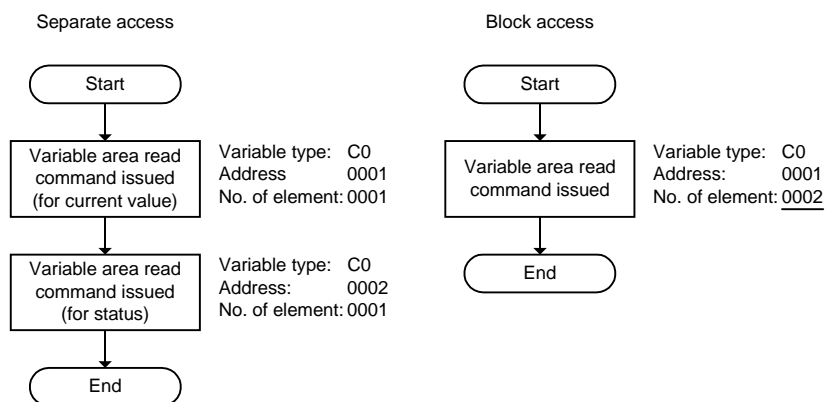

7.11 Communications Control Flow

This section describes the control flow of communications between the product and the host PC. Information in this section will help you make up a program for controlling the product.

■ Communication Reading

Communication reading is performed according to the following flow. It involves no response from the product to the host PC.

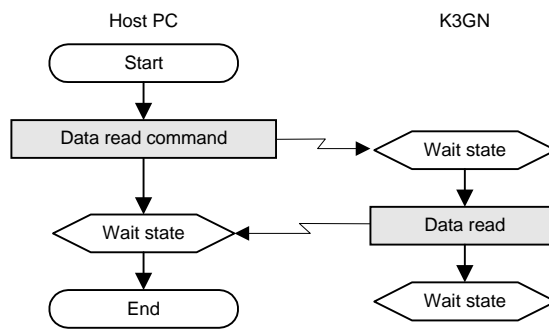

Commands applicable to this flow are shown below.

Applicable commands
Read process value
Read status
Read OUT set value
Read parameter
Read controller attribute
Read controller status
Read version
Echoback test

■ Communication Writing (Setting Area 0)

When the product is in setting area 0, communication writing is performed according the following flow.

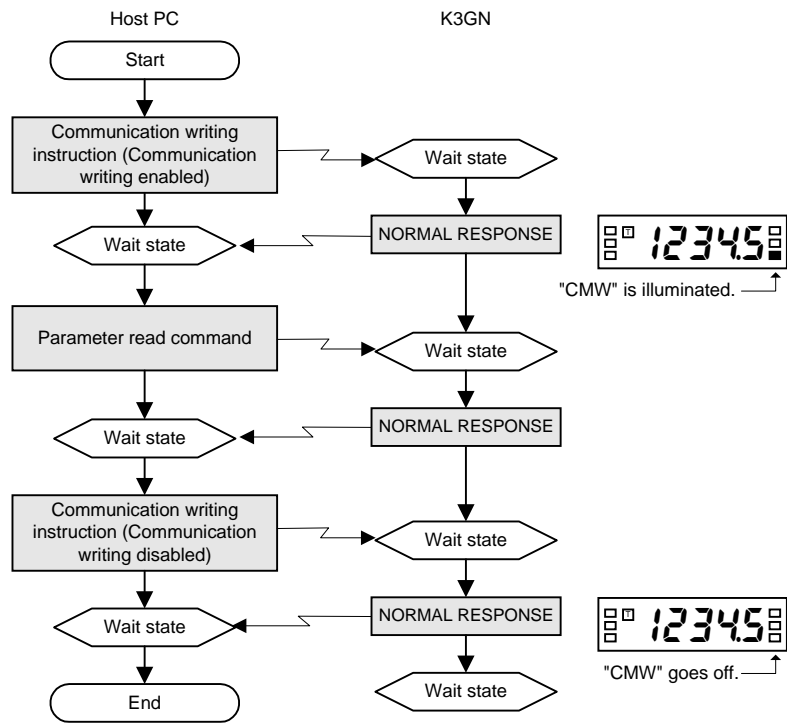

Commands applicable to this flow are as follow.

Applicable commands
Write remote input value
Write OUT set value

Remote input values would often be written with a high frequency. You should therefore keep “communication writing” in “enable” state and then continuously write input values. Doing so will shorten the time for communication writing.

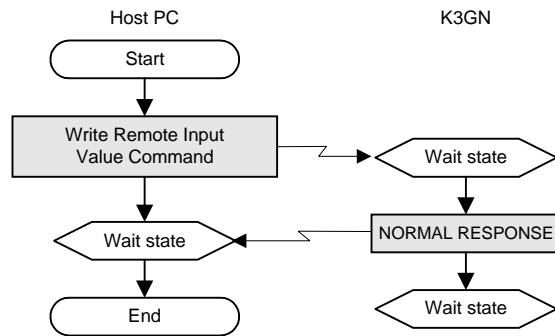

It is assumed that communication writing has been enabled.

■ Protect Level Parameter Writing

A protect level parameter is written according to the following flow.

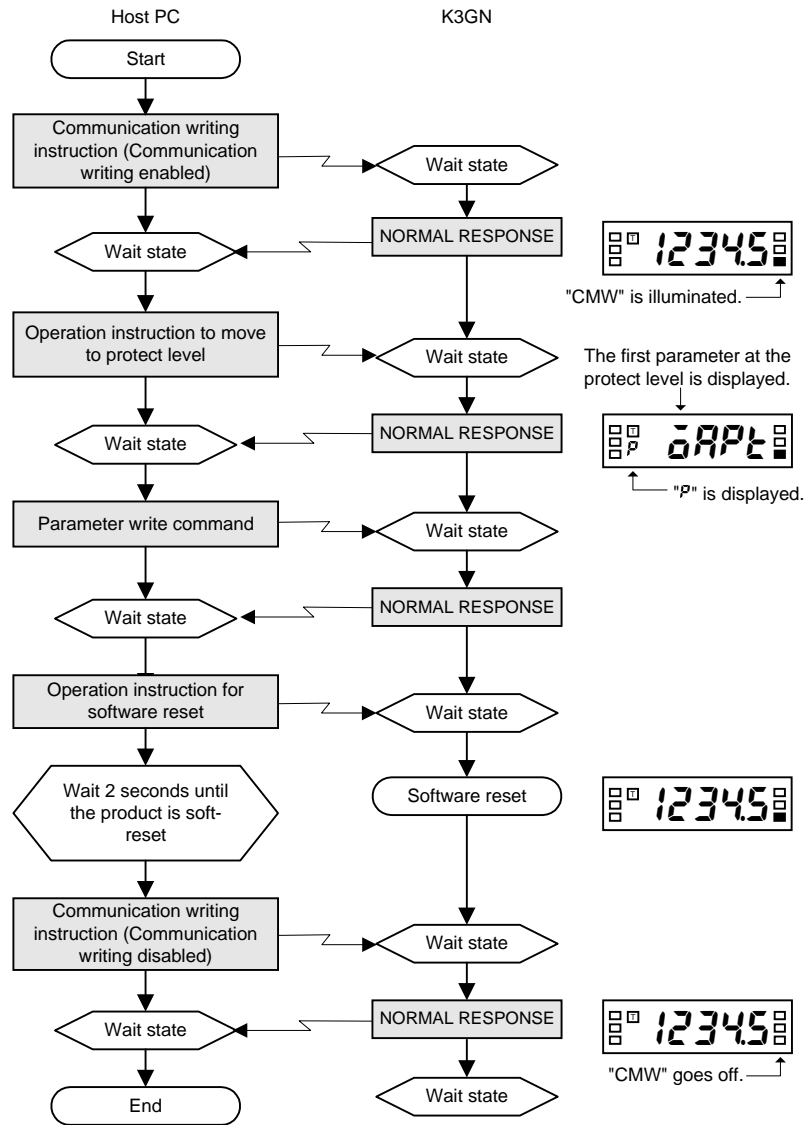

The following command is applicable to this flow.

Applicable command
Write protect level parameter

■ Parameter Writing (Setting Area 1)

When the product is in setting area 1, a parameter is written according to the following flow.

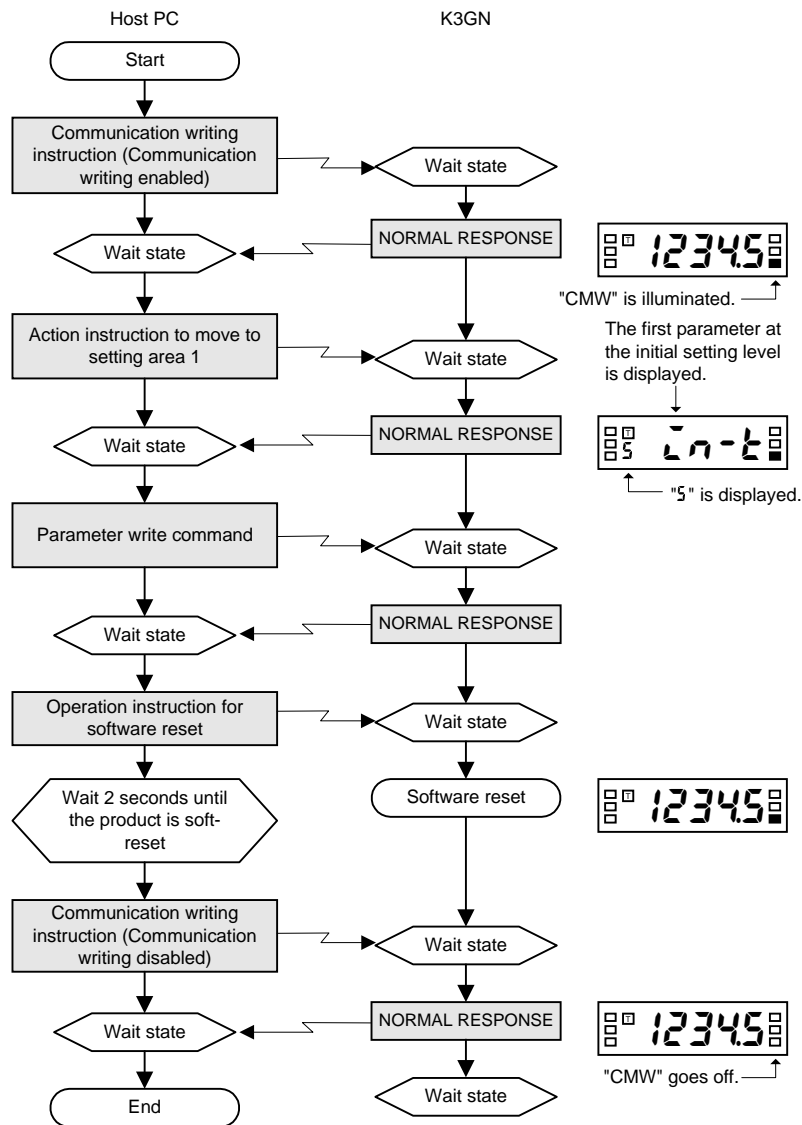

COMMUNICATIONS

The following command is applicable to this flow.

Applicable command
Write parameter (setting area 1)

■ **Operation Instruction**

An operation instruction is performed according to the following flow.

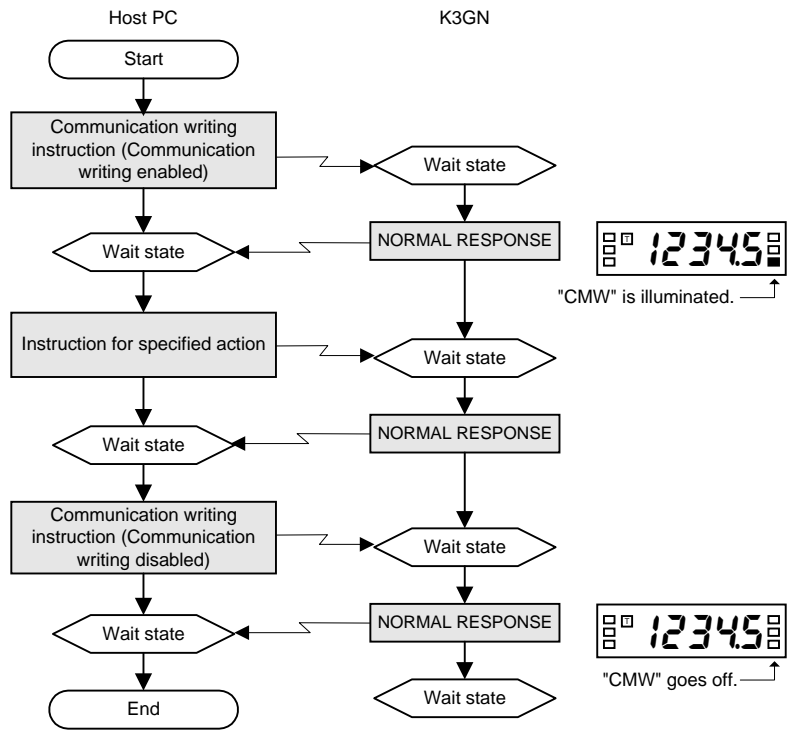

Commands applicable to this flow are shown below.

Applicable commands
Forced-forced-zero execution/cancel
Move to setting area 1
Move to protect level

7.12 Programming Example

■ N88 BASIC

The section shows a programming example where a response from the product is displayed on the screen on the host PC when a command is entered from the keyboard.

This program is created with N88 BASIC.

```

1000 '-----
1010 'PROGRAM: K3GN Communication Sample Program(CompoWay/F)
1020 'VERSION:1.00
1030 '(C)Copyright OMRON Corporation 1999
1040 'All Rights Reserved
1050 '-----
1060 '
1070 '===== Baud rate setting (PARITY=EVEN,DATA=7,STOP=2) =====
1080 'COM port settings
1090 OPEN "COM:E73" AS #1
1100 '
1110 *REPEAT
1120 '
1130 '===== Transmission processing =====
1140 '
1150 '-----SD input-----
1160 INPUT "SEND DATA:",SEND$
1170 '
1180 '-----If not input, go to end processing-----
1190 "IF SEND$ = "" THEN *EXIT
1200 '
1210 '-----BCC calculation-----
1220 BCC = 0
1230 SEND$ = SEND$+CHR$(3)
1240 FOR I=1 TO LEN(SEND$)
1250 " BCC = BCC XOR ASC(MID$(SEND$,I,1))
1260 NEXT I
1270 BCC$ = CHR$(BCC)
1280 '
1290 '-----Transmission-----
1300 SDATA$ = CHR$(2)+SEND$+BCC$
1310 PRINT #1,SDATA$;
1320 '
1330 '=====Reception processing=====
1340 '
1350 RDATA$ = ""
1360 TIMEOUT = 0
1370 *LOOP
1380 '-----No-response detection-----
1390 TIMEOUT = TIMEOUT+1
1400 IF TIMEOUT > 2000 THEN RESP$ = "No Response":GOTO *REND
1410 IF LOC(1) = 0 THEN *LOOP
1420 '
1430 '-----Ending character identification (if not ending character,
continue reading)
1440 RDATA$ = RDATA$+INPUT$(LOC(1),#1)
1450 IF LEN(RDATA$) < 2 THEN *LOOP
1460 IF MID$(RDATA$,LEN(RDATA$)-1,1) <> CHR$(3) THEN *LOOP
1470 RESP$ = MID$(RDATA$,2,LEN(RDATA$)-2)
1480 *REND

```

```

1490  '
1500  '-----Received data display-----
1510  PRINT "RESPONSE:";RESP$
1520  GOTO *REPEAT
1530  '
1540  *EXIT
1550  '----- Termination -----
1560  CLOSE #1
1570  END
    
```

● Execution example

The current value of unit No. 00 is read.

```

RUN
SEND DATA:000000101C00001000001
RESPONSE:000000010100000000014F
    
```

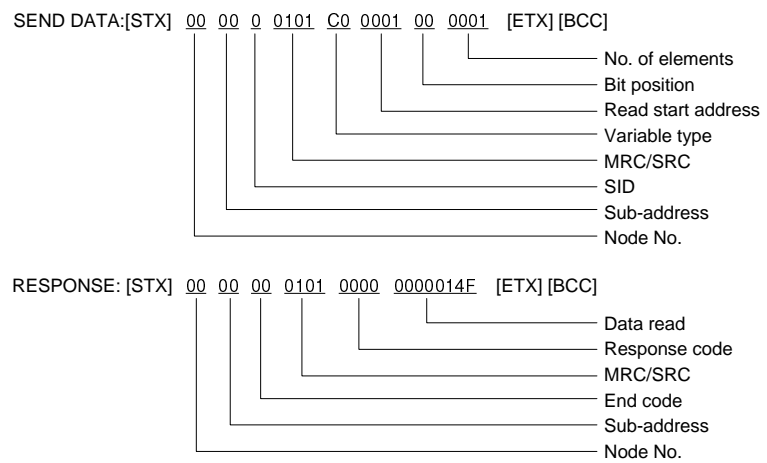

■ Protocol Macro

What is the protocol macro?

The protocol macro is a ladder routine that, using a PMCR command, provides control to the sequence (protocol) of data communications between PLCs or other communication devices connected via RS-232C or RS-422A/485 interface.

OMRON's CS1W series of serial communication boards come standard with a standard system protocol that allows control of OMRON's components.

For details on the protocol macro, refer to the User's Manual for Model CS1W-SCB21/41/-SCU21 (Cat. No. W336-01).

Connection

The serial communication board CS1W-SCB41 has two ports, port 2 of which allows direct connection via RS-485 interface.

Use this port to connect the board to the product.

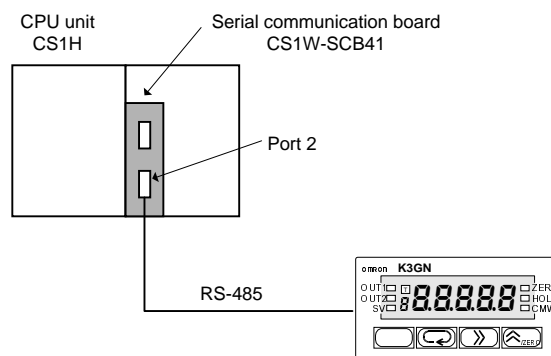

Set the TERM switch to "ON" and the WIRE switch to "2" and connect a terminator to the K3GN.

Ladder Example

The following example is a ladder diagram in which the current process value is read through communications (with responses) with No. 600 ASCII conversion according to the standard system protocol "CompoWay/F for Master Station".

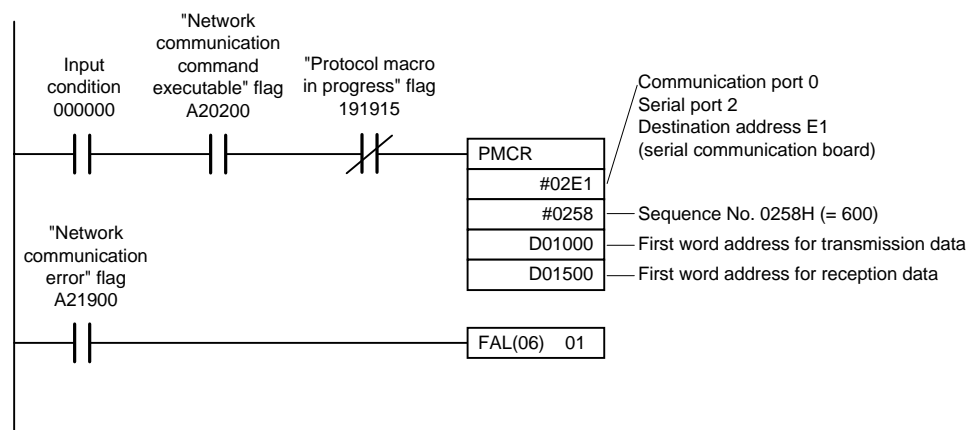

Placing the "read process value" command in D0100 or a higher-numbered location causes the process value to be stored in D0152 ~ D0153.

If a communication error occurs, an FAL command (fault analysis command) is executed.

COMMUNICATIONS

● Data transmission word assignment

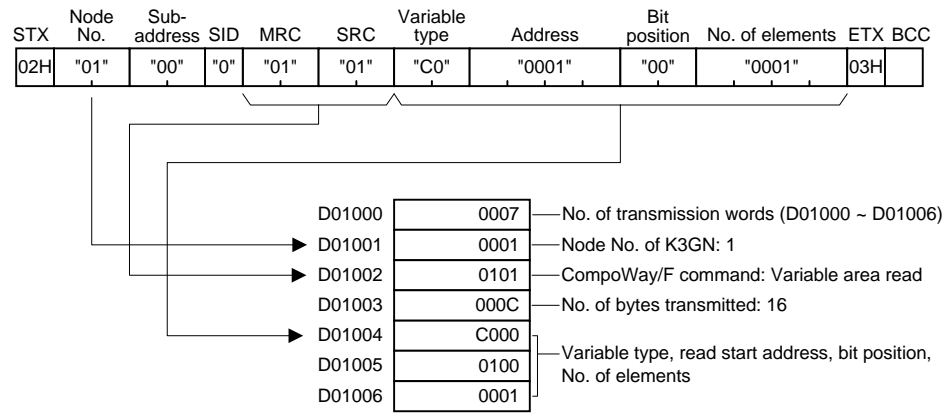

● Data reception word assignment

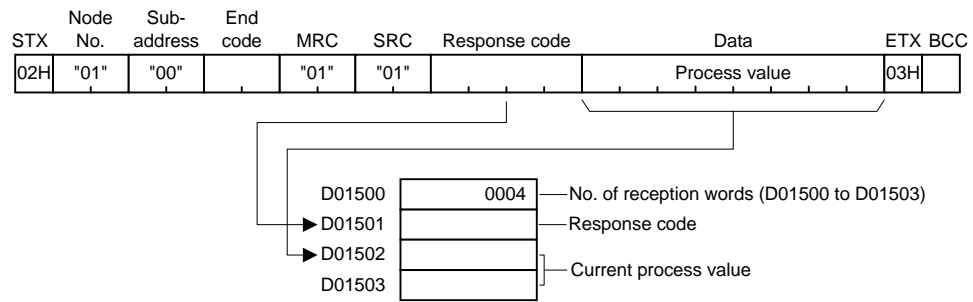

CHAPTER

8

**USER
CALIBRATION**

The product allows the user to perform analog input calibration. This chapter outlines user calibration and describes how to calibrate the product.

8.1 User Calibration 126
8.2 User Calibration Processes 128
 Connection of the Product to a STV/Calibration Procedure

8.1 User Calibration

As the product has been calibrated at the factory, it does not need to be calibrated in normal use.

The product has the capability of analog input calibration, which enables user calibration as needed.

OMRON assumes no responsibility for the result of user calibration.

Note that, once user calibration is performed, original calibration data is overwritten and cannot be restored.

Devices and tools necessary for user calibration must be made available by the user. For handling of these devices, refer to their respective manuals.

Entry of Calibration data

First store both of calibration values 1 and 2 temporarily. Then save them while the product is in the change state.

Calibration data cannot be saved normally unless calibration values 1 and 2 are both specified.

If calibration data is saved normally, the product keeps a record of the user calibration. When you enters the user calibration level, a calibration record mark will appear on the main indicator as shown below.

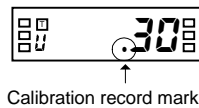

Calibration Flow

The following shows the flow of user calibration.

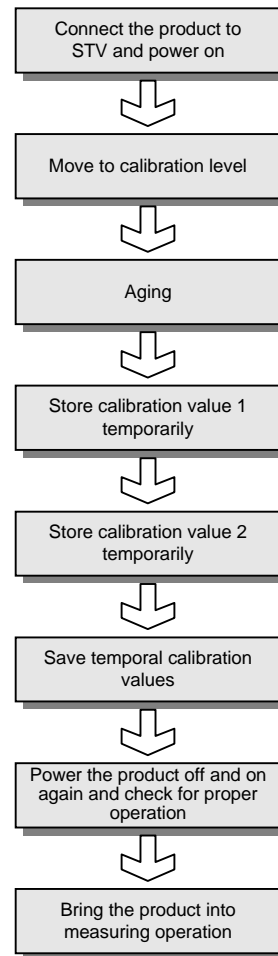

In the above flow, a range specified by the “analog range” parameter undergoes calibration.

If you want to calibrate another range, change the analog range to the desired one at the initial setting level and then perform calibration according to the above flow.

To exit from the calibration level, power the product off and on again.

8.2 User Calibration Processes

■ Connection of the Product to a STV

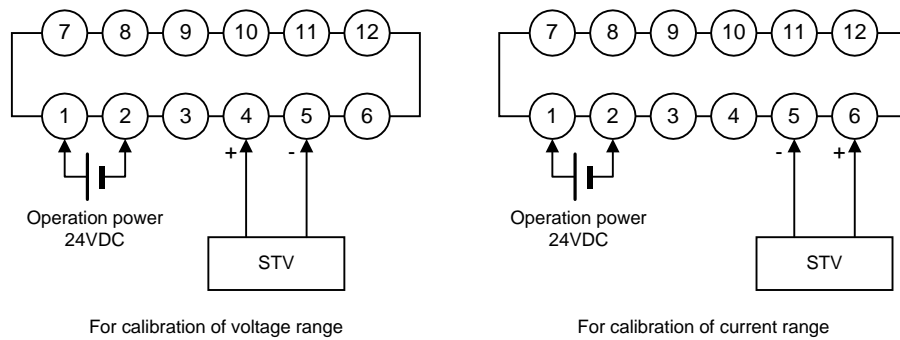

Connect a STV (standard voltage/current generator) to appropriate terminals as shown above.

Use a STV that has accuracy appropriate to the precision of the product.

■ Calibration Procedure

Take the following steps for user calibration.

Move to the Calibration Level

Procedure

A. At the advanced-function setting level, press the key.

- Parameter $\bar{L} \bar{H} \bar{L} \bar{U}$ will appear on the main indicator.
- If you cannot move to the calibration level at the first attempt after purchasing the product, set the "initial setting/communication lockout" parameter to "0" at the protect level and then move to the advanced-function setting level.

B. Press the key.

- The set value (password) of the parameter will appear on the main indicator.

C. Press the key again to allow the password to be changed.

D. Use the and keys to enter a password of "01201".

E. Press the key to save the password.

- If the password is correct, the product enters the calibration level.
- If the password is incorrect, the product remains at the advanced-function setting level and its main indicator displays the next parameter.

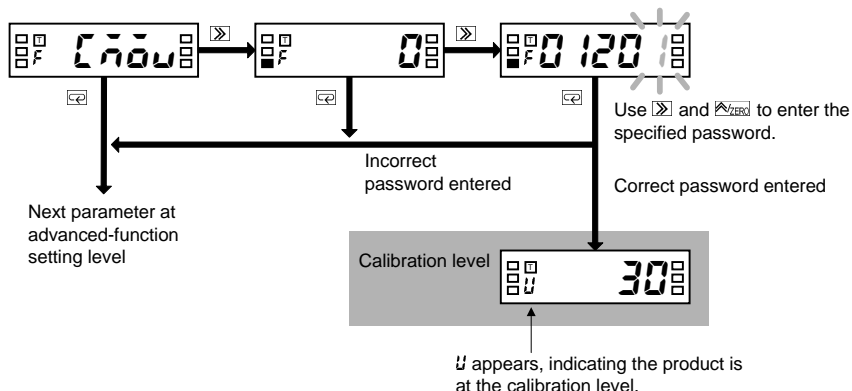

At the Calibration Level

Procedure

A. Follow the above steps to move to the calibration level.

- An aging timer count will appear on the main indicator.
- The aging timer is a 30-minute timer and counts down to 0.
- If a user calibration record is found, a calibration record mark will appear.

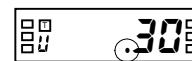
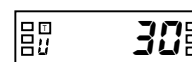

Calibration record mark

B. Perform aging until the aging timer counts down to 0. (If the STV needs an aging time longer than 30 minutes, continue aging until the aging requirement of the STV is satisfied).

- If you press the [left arrow] key in the middle of timer counting, aging is skipped and the parameter of calibration value 1 is displayed on the main indicator.



C. Press the [left arrow] key to display the parameter of calibration value 1.

- The parameter corresponding to the current analog range will appear on the main indicator. For the relationship between the analog range and the parameter, refer to the table on the next page.

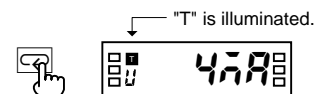

"T" is illuminated.

D. Press the [right arrow] key to display the set value of the parameter.

- The calibration value 1 will appear in hexadecimal on the main indicator.

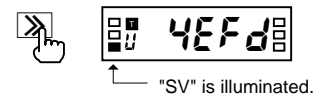









"SV" is illuminated.

E. Use the STV to provide a reference signal corresponding to calibration value 1.

- For the value of reference signals, refer to the table on the next page.

USER CALIBRATION

- F.** Press the  key.
- The teaching indicator will start blinking, indicating the reference signal is given to the product.
- G.** Press the  key again to temporarily store calibration value 1.
- If you press the  key instead of the  key, calibration value 1 is not stored and the parameter of calibration value 2 is displayed on the main indicator.
- H.** Press the  key to display the parameter of calibration value 2.
- I.** Repeat steps **D** to **H** to temporarily store calibration value 2.
- Parameter **5tr** will appear on the main indicator, indicating the temporal calibration values can be saved.
 - This parameter does not appear unless both calibration values 1 and 2 have been stored temporarily.
- J.** Press the  key to display the set value.
- no** will appear on the main indicator.
- K.** Press the  key again.
- The set value will start blinking, indicating the product is in the change state.
- L.** Press the  key.
- YES** will appear on the main indicator.
- M.** Press the  key.
- The calibration values are saved.
 - The aging timer count will appear on the main indicator.
- N.** Power the product off and on again to exit from the calibration level, and check for proper operation.

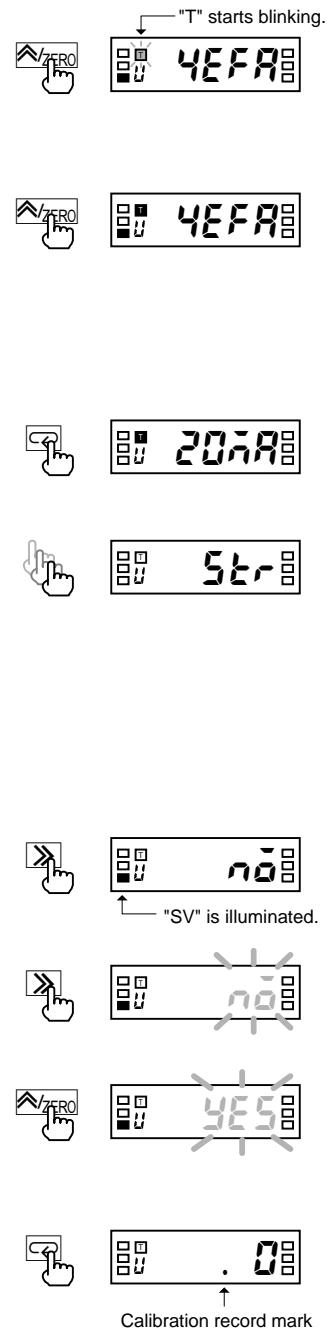

● Analog ranges and parameters/reference signals

Analog range	Calibration value 1		Calibration value 2	
	Parameter	Reference signal	Parameter	Reference signal
4 to 20 mA	4nA	4.00 mA	20nA	20.00 mA
1 to 5V	1u	1.000V	5u	5.000V
±5V	5u	5.000V	-5u	-5.000V
±10V	10u	10.000V	-10u	-10.000V



CHAPTER



9

TROUBLESHOOTING GUIDE

This chapter shows the meanings of error indications and the remedial actions to be taken in the event of error. It also contains a troubleshooting table that will be helpful in case a trouble may arise.

9.1	Error Indications	132
9.2	Troubleshooting Table.....	133

9.2 Troubleshooting Table

Symptom	Probable cause	Remedy	Reference page
The forced-zero function is inoperative even though the  key is pressed.	The “input type” parameter is set to “pulse”.	The forced-zero function is not available.	50 90
	Forced-zero lockout is active.	At the protect level, set the forced-zero function to “enable”.	48
The product does not enter the protect level even though the  +  is held down for 5 seconds.	The “move-to-protect-level” parameter is set to a value more than 5.	Set the “move-to-protect-level” parameter to an appropriate value.	76
Readouts vary greatly or decrease with increasing rotational speed.	The “input-pulse frequency range” parameter is set to “30 Hz”.	If the input pulse frequency exceeds 30 Hz, set the “input-pulse frequency range” parameter to “5 kHz”.	52 88
	The input pulse frequency exceeds 5 kHz.	Lower the input pulse frequency to 5 kHz or less. Note that the product does not generate an out-of-range error if the input pulse frequency exceeds 5 kHz.	
Readouts vary or are incorrect even when the rotational speed is low.	The pulse width of ON/OFF signals is too small.	Supply the product with pulses that have a width specified in this manual. The product cannot recognize input pulses correctly unless their width is as specified, even if the rotational speed is low.	88
The main indicator reads 0 when the rotational speed is low.	The “auto-zero time” parameter is set to a value that is not more than the maximum time interval of input pulses.	Set the “auto-zero time” parameter to a value exceeding the maximum time interval of input pulses.	68
		Otherwise, the auto-zero function may be triggered improperly.	86

TROUBLESHOOTING GUIDE

Symptom	Probable cause	Remedy	Reference page
The product continues to read "00000" on the main indicator since powered on.	The set value of the "startup compensation timer" parameter is too large.	Set the "startup compensation timer" parameter to an appropriate value. When the input type is set to "pulse", the startup compensation time can be set to up to 99.9 seconds.	70 86
	The "process value hold" function is active.	Cancel "process value hold". If the event input terminal is used for "process value hold", powering on the product in the ON state of the terminal will result in a readout of "00000", which is retained unless the terminal turns off.	89
The event/pulse input terminals cannot be turned on or off at all or sometimes.	The making residual current and/or breaking leakage current of input equipment are outside the specified limits.	Use such input equipment that conforms to the requirements of the making residual current and breaking leakage current specifications. Otherwise, the product cannot detect the ON/OFF signals from input equipment.	13
The product does not return responses at all to the host PC.	Wiring is incorrect.	Check wiring for correct connection and A/B polarity.	14
	The command frame contains a wrong unit No.	Specify a correct unit No. Otherwise, the product will not return a response to the host PC.	97
Comparative output does not turn off even when a process value goes back to normal.	The set value of the "hysteresis" parameter is too large.	Set the "hysteresis" parameter to an appropriate value.	66
			92

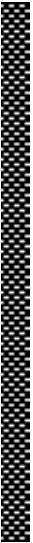
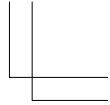
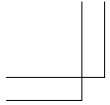

APPENDIX



Specifications 136
Parameter List 139
ASCII Code Table 140

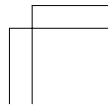
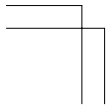
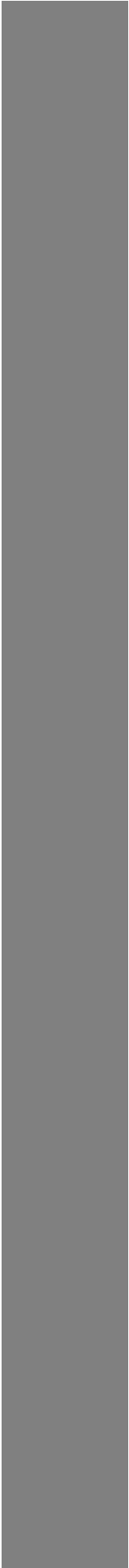

Specifications

■ Ratings

Supply voltage	24 VDC
Operating voltage range	85% to 110% of the rated supply voltage
Power consumption (see note)	2.5W max. (at max. DC load with all indicators lit)
Insulation resistance	20 MΩ min. (at 500 VDC) between external terminal and case. Insulation provided between inputs, outputs, and power supply.
Dielectric withstand voltage	1,000 VAC for 1 min between external terminal and case. Insulation provided between inputs, outputs, and power supply.
Noise immunity	±480 V on power supply terminals in normal mode, ±1,500 V in common mode, ±1 μs, or 100 ns for square-wave noise with 1 ns
Vibration resistance	Malfunction: 10 to 55 Hz, 10 min each in X, Y, and Z directions; acceleration: 9.8 m/s ² Destruction: 10 to 55 Hz, 30 min each in X, Y, and Z directions; acceleration: 19.6 m/s ²
Shock resistance	Malfunction: Models with transistor outputs: 196 m/s ² for 3 times each in X, Y, and Z directions Models with relay contact outputs: 98 m/s ² for 3 times each in X, Y, and Z directions Destruction: 294 m/s ² for 3 times each in X, Y, and Z directions
Ambient temperature	Operating: -10°C to 55°C (with no condensation or icing) Storage: -25°C to 65°C (with no condensation or icing)
Ambient humidity	Operating: 25% to 85% (with no condensation)
Ambient atmosphere	Must be free of corrosive gas
EMC	Emission Enclosure: EN55011 Group 1 class A Emission AC Mains: EN55011 Group 1 class A Immunity ESD: EN61000-4-2: 4-kV contact discharge (level 2) 8-kV air discharge (level 3) Immunity-RF-interference: ENV50140: 10 V/m (amplitude modulated, 80 MHz to 1 GHz) (level 3) 10 V/m (pulse modulated, 900 MHz) Immunity Conducted Disturbance: ENV50141: 10 V (0.15 to 80 MHz) (level 3) Immunity Burst: EN61000-4-4: 2-kV power line (level 3) 2-kV I/O signal-line (level 4)
Approved standards	UL508 (pending), CSA22.2 (pending); conforms to EN50081-2, EN50082-2, EN61010-1 (IEC61010-1); conforms to VDE106/part 100 (Finger Protection) when the terminal cover is mounted.
Weight	Approx. 100 g

Note: A operation power supply capacity greater than the rated capacity is required when the Digital Panel Meter is turned ON. Do not forget to take this into consideration when using several Digital Panel Meters. When power is supplied, all indicators will light and outputs will be OFF. When using startup compensation time operation, the display will read "00000" and all outputs will be OFF.

■ Input/Output Ratings

Relay Contact Output

(Incorporating G6K Relays)

Item	Resistive load ($\cos\phi = 1$)
Rated load	1 A at 30 VDC
Rated carry current	1 A max. (at COM terminal)
Max. contact voltage	60 VDC
Max. contact current	1 A (at COM terminal)
Max. switching capacity	30 VA
Min. permissible load (P level, reference value)	10 mV, 10 μ A
Mechanical life	50,000,000 times min. (at a switching frequency of 36,000 times/hr)
Electrical life (at an ambient temperature of 23°C)	100,000 times min. (at the rated load with a switching frequency of 1,800 times/hr)

Transistor Output

Rated load voltage	24 VDC
Max. load current	50 mA
Leakage current	100 μ A max.

■ Communications

Item	RS-485	
Transmission method	2-wire, half-duplex	
Synchronization method	Start-stop synchronization	
Baud rate	1,200/2,400/4,800/9,600/19,200 bps	
Transmission code	ASCII	
Communications	Reading/Writing to the K3GN	Read/write set values, read/write scaling values, enable/disable the writing of data through communications, forced-zero control, and other data.

■ Measuring Ranges

Process Voltage/Current Inputs

Input	Measuring range	Measuring accuracy	Input impedance	Display range
DC voltage	1.000 to 5.000 V/ 0.000 to 5.000 V	$\pm 0.1\%$ FS ± 1 digit max. (at 23 $\pm 3^\circ$ C)	1 M Ω min.	-19999 to 99999 (with scaling function)
	-5.000 to 5.000 V	$\pm 0.1\%$ FS ± 1 digit max. (at 23 $\pm 5^\circ$ C)		
	-10.00 to 10.00 V			
DC current	4.00 to 20.00 mA/ 0.00 to 20.00 mA	$\pm 0.1\%$ FS ± 1 digit max. (at 23 $\pm 3^\circ$ C)	60 Ω	

No-voltage Contact/Open Collector Inputs

Input	Measuring range	Measuring accuracy (at 23 $\pm 5^\circ$ C)	Displayable range
No-voltage contact (30 Hz max.) with ON/Off pulse width of 16 ms min.	0.05 to 30.00 Hz	$\pm 0.1\%$ FS ± 1 digit max.	-19999 to 99999 (with scaling function)
Open collector (5 kHz max.) with ON/OFF pulse width of 90 μ s min.	0.1 to 5000.0 Hz		

Digital Data Display (By RS-485 Communication)

Displayable range	-19999 to 99999
-------------------	-----------------

■ Characteristics

Input signal	Process voltage (1 to 5 V, 0 to 5 V, ± 5 V, ± 10 V) Process current (4 to 20 mA, 0 to 20 mA)	No-voltage contact (30 Hz max. with ON/OFF pulse width of 16 ms min.) Open collector (5 kHz max. with ON/OFF pulse width of 90 μ s min.)	Digital data display (by RS-485 communication)
A/D conversion method	Double integral method	—	
Sampling period	250 ms	—	
Display refresh period	Sampling period (sampling times multiplied by number of averaging times if average processing is selected.)		
Pulse measurement method	—	Periodic measurement	—
Connectable Sensors	—	ON residual voltage: 2.5 V max. OFF leakage current: 0.1 mA max. Load current: Must have a switching capacity of 15 mA min. Must be able to reliably switch load currents of 5 mA max.	
Max. displayed digits	5 digits (-19999 to 99999)		
Display	7-segment digital display, character height: 7.0 mm		
Polarity display	“-” is displayed automatically with a negative input signal.		
Zero display	Leading zeros are not displayed.		
Scaling function	Programmable with front-panel key inputs (range of display: -19999 to 99999). The decimal point position can be set as desired.		
External controls (see note 1)	HOLD: (Measurement value held) ZERO: (Forced-zero)	—	HOLD: (Measurement value held) ZERO: (Forced-zero)
Hysteresis setting	Programmable with front-panel key inputs (0001 to 9999)		
Other functions	Programmable Color Display Selectable output operating action Teaching set values Average processing (simple average) Lockout configuration Communications writing control (communications output models only)		
	Forced-zero set with front panel keys Control inputs (HOLD/ZERO) selection via front panel keys Field calibration	Startup compensation time (0.00 to 99.9 s) Auto-zero time (0.0 to 19.9 s)	Forced-zero set with front panel keys Control inputs (HOLD/ZERO) selection via front panel keys
Output	Relays: 2 SPST-NO Transistors: 3 NPN open collector 3 PNP open collector	—	
	Combinations: Communications output (RS-485) + relay outputs (2 SPST-NO); Communications output (RS-485) + transistor outputs (3 NPN open collector); Communications output (RS-485) + transistor outputs (3 PNP open collector)		
Communications	Communications function: RS-485		
Delay in comparative outputs (transistor outputs)	750 ms max.		
Enclosure ratings	Front panel: NEMA4X for indoor use (equivalent to IP66) Rear case: IEC standard IP20 Terminals: IEC standard IP20		
Memory protection	Non-volatile memory (EEPROM) (possible to rewrite 100,000 times)		

Note 1: The minimum input time for control signals is 80 ms.

Parameter List

Use this list to note your set values.

Level	Parameter	Indication	Setting range	Default	Unit	Set value
Protect	Operation/adjustment lockouts	ãRPlt	0 ~ 2	0		
	Initial setting/communication lockouts	ãCPlt	0 ~ 2	1		
	Setting change lockout	ãtPlt	ãFF/ãn	ãFF		
	Forced-zero lockout	ãrPlt	ãFF/ãn	ãFF		
Operation	OUT1 value	ãUt 1	-19999 ~ 99999	99999		
	OUT1 upper-limit value	ãUt 1H	-19999 ~ 99999	99999		
	OUT1 lower-limit value	ãUt 1L	-19999 ~ 99999	-19999		
	OUT2 value	ãUt 2	-19999 ~ 99999	-19999		
	OUT2 upper-limit value	ãUt 2H	-19999 ~ 99999	99999		
	OUT2 lower-limit value	ãUt 2L	-19999 ~ 99999	-19999		
Adjustment	Communication writing	ãããt	ãFF/ãn	ãFF		
Initial setting	Input type	ãn-t	RnRLG/PUL SE/rãt	RnRLG		
	Analog range	rRnGE	4-20/1-5/5/10	4-20		
	Input-pulse frequency range	P-FrE	30/5P	5P	Hz	
	Scaling input value 1	ãnP.1	-19999 ~ 99999	4.00		
	Scaling display value 1	dSP.1	-19999 ~ 99999	400		
	Scaling input value 2	ãnP.2	-19999 ~ 99999	20.00		
	Scaling display value 2	dSP.2	-19999 ~ 99999	2000		
	Scaling input value	ãnP	-19999 ~ 99999	5000.0		
	Scaling display value	dSP	-19999 ~ 99999	50000		
	Decimal point position	dP	0.0000/00.000/000.00/ 0000.0/00000	000.00		
	OUT1 type	ãUt 1t	Hã/Lã/Hã-Lã	Hã		
	OUT2 type	ãUt 2t	Hã/Lã/Hã-Lã	Lã		
	Move to advanced-function setting level	Rããu	-19999 ~ 99999	0		
	Communication setting	Communication unit No.	ã-nã	0 ~ 99	1	
Baud rate		bPS	1.2/2.4/4.8/9.6/19.2	9.6	kbps	
Word length		LEn	7/8	7	bit	
Stop bit length		ãbãt	1/2	2	bit	
Parity check		Prãtã	nãnE/EuEn/ãdd	EuEn		
Advanced-function setting	Parameter initialization	ãããt	ãFF/ãn	ãFF		
	No. of measurements for averaging	Ruã	ãFF/2/4/8	ãFF	times	
	Event input function selection	EuEnãt	HãLd/ãErã	HãLd		
	OUT1 hysteresis	Hãã1	0 ~ 9999	1		
	OUT2 hysteresis	Hãã2	0 ~ 9999	1		
	Auto-zero time	Ruããã	0.0 ~ 19.9	19.9	s	
	Startup compensation timer	ã-tãr	0.0 ~ 99.9	0.0	s	
	Display color change	ããããr	ãrã-r/ãrã/rãd-ã/rãd	ãrã-r		
	Display auto-return time	rããt	0 ~ 99	10	s	
	Move-to-protect-level time	Prããt	0 ~ 19	5	s	
	Send waiting time	ãããt	0 ~ 99	20	ms	
Move to calibration level	ãããu	-19999 ~ 99999	0			

ASCII Code Table

Upper Lower	0	1	2	3	4	5	6	7
0	NUL	DLE	SPACE	0	@	P		p
1	SOH	DC1	!	1	A	Q	a	q
2	STX	DC2	"	2	B	R	b	r
3	ETX	DC3	#	3	C	S	c	s
4	EOT	DC4	\$	4	D	T	d	t
5	ENQ	NAK	%	5	E	U	e	u
6	ACK	SYN	&	6	F	V	f	v
7	BEL	ETB	'	7	D	W	g	w
8	BS	CAN	(8	H	X	h	x
9	HT	EM)	9	I	Y	i	y
A	LF	SUB	*	:	J	Z	j	z
B	VT	ESC	+	;	K	[k	{
C	FF	FS	,	<	L	¥	l	
D	CR	GS	-	=	M]	m	}
E	SO	RS	.	>	N	^	n	~
F	SI	US	/	?	O	_	o	DEL

Index

A

adapter	10
address	100
adjustment	38
adjustment level	40
advanced-function setting	38
advanced-function setting level	40
alphabets	44
analog input	5, 13
analog photoelectric sensor	20
analog range	51, 114
ASCII character	97
auto-zero	86
auto-zero function	24
auto-zero time	68, 115
average processing	87

B

baud rate	115
BCC	97, 98

C

calibration	38
change state	44
chattering noise removal	88
check and change OUT set value	45
clearing all parameters	62
command frame	97
command text	97
commands and responses	105
communication	14
communication parameters	60
communication procedure	96
communication reading	116
communication setting	38
communication setting level	40
communication specification	96
communication unit No.	115
communication writing	109
communication writing (setting area 0)	117
comparative output	2, 14, 91
CompoWay/F	96
contact output	5
current leakage with transistor turned ON	13
current value	113

D

decimal point position	58, 115
dimensions	10

display auto-return time	74, 115
display color	72
display color change	93, 115

E

echoback test	99, 112
end code	98
error indications	132
ETX	97, 98
event input	13, 64, 88
event input function	115
event input/pulse input	5

F

FINS	96
forced-forced-zero execution	103
forced-zero	46, 88, 90
forced-zero cancel	103
forced-zero execution/cancel	109
forced-zero lockout	48, 114
frame	97

H

hexadecimal number	97
hysteresis	20, 66, 92

I

I/O circuits	5
I/O terminal connections	12
initial setting	30, 38
initial setting level	40
initial setting/communication lockouts	48, 114
input circuit diagrams	5
input pulse frequency	82, 114
input range over	30
input type	50, 114
input-pulse frequency range	52
inrush current	19
installation	10
installation procedure	11
internal block diagram	6

K

key protect	48
-------------------	----

L

levels.....	38
load	14
load current	13
lower-limit action.....	18, 22, 24, 91

M

main features.....	2
measurement.....	82
Model number legend	4
monitor state	44
move to protect level	103, 110
move to setting area 1	103, 110
move-to-protect-level time	76, 115
MRC	99
MRES	99

N

N88 BASIC.....	121
node No.....	97, 98
number of measurements for averaging.....	63, 87
numerics.....	44

O

OFF leakage current	13
ON and OFF pulses.....	88
ON residual current.....	13
operating voltage range.....	13
operation	38
operation instruction	99, 103, 120
operation/adjustment lockouts	48, 114
OUT1 hysteresis	115
OUT1 lower-limit value.....	46
OUT1 type	115
OUT1 upper-limit value.....	46
OUT1 value	46
OUT2 hysteresis	115
OUT2 lower-limit value.....	46
OUT2 type	115
OUT2 upper-limit value.....	46
OUT2 value	46
output circuit diagrams	5
output operating action	59
outside-the-range action.....	91

P

panel cutout dimensions.....	10
parameter	42
parameter writing (setting area 1)	119
parity bit.....	115
password	40
PMCR command	123

power consumption	13
power supply	13
power supply capacity	13
pressure sensor	22
process meter	30
process value hold	88, 89
programming example.....	121
protect.....	38
protect level	40
protect level parameter writing.....	118
protocol macro.....	123
pulse input	13, 88

R

read controller attribute	99, 111
read controller status.....	99, 111
read from variable area.....	99, 101
read parameter	107
read process value	105
read remote input value	106
read status	105
read version	112
remote indicator.....	34
remote input value	114
response frame.....	98
response text.....	98

S

sampling	82
scaling.....	2, 84
scaling display value	114
scaling display value 1	114
scaling display value 2	114
scaling factor	53, 55, 84
scaling input value.....	114
scaling input value 1.....	114
scaling input value 2.....	114
scaling operation error.....	32, 57
send waiting time.....	78, 115
serial communication board	123
set value.....	44
setting areas	104
setting change lockout	48, 114
shift.....	3, 90
SID	97
software reset.....	103, 104, 110
SRC	99
SRES	99
startup compensation.....	86
startup compensation time	70, 115
startup compensation timer.....	24
status.....	113
stop bit length	115
STV	128
STX	97, 98
sub-address	97, 98
supply voltage.....	13

T

tachometer 32
teaching function 54, 56
terminal arrangement..... 12
terminal connection 12
tightening torque 11
transistor output..... 6
transmission line connection 96
twisted-pair cable 14

U

ultrasonic displacement sensor 16
upper-limit action 18, 20, 22, 24, 91
user calibration 126

V

variable..... 100
variable area 100
variable area map 113
variable type..... 100
version..... 113

W

waterproof..... 11
watertight packing..... 11
word length 115
write OUT set value 107
write parameter (setting area 1) 108
write protect level parameter..... 108
write to variable area..... 99, 102