

850/851/852/853 Series Enclosed Fuse Holders for 5x20mm Fuses

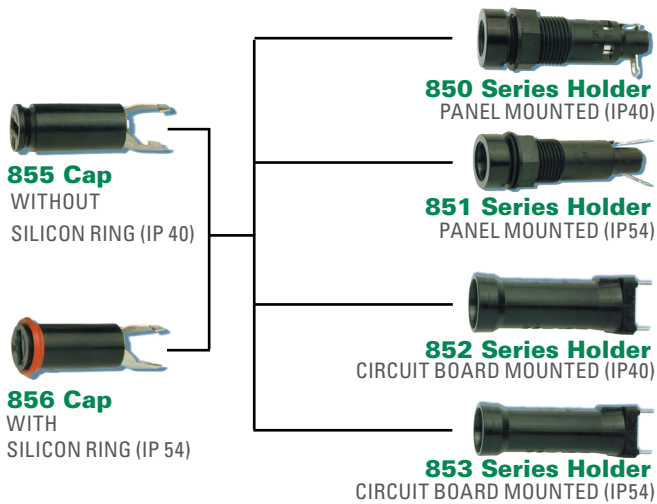

Agency Approval	
Agency	Agency File Number
	850 and 851 - 40034355 852 and 853 - 40033885
	E70164

Additional Information



Datasheet
850 Series



Resources
850 Series



Samples
850 Series



Datasheet
851 Series



Resources
851 Series



Samples
851 Series



Datasheet
852 Series



Resources
852 Series



Samples
852 Series



Datasheet
853 Series



Resources
853 Series



Samples
853 Series

Product Characteristics

	850/851 Series	852/853 Series
Compatible Fuse	5x20mm	
Materials	Holder: Black Thermoplastic Cap: Black Thermoplastic Both UL94V0	Holder/Cap: Black Thermoplastic, UL 94V0
	Sealing Ring: Silicon (Cap 856)	
	Metal Parts: Copper alloy, corrosion protected	
	Terminals: Solderable tinned	
Electrical Data (23°C)	Rated Voltage: 250V	
	Rated Current: 10 A	Rated Current: 6.3A (VDE) 12A (UL)
	Rated Power: 4W (VDE)	Rated Power: 2W (VDE)
Mounting	12.7mm diameter D-hole or 13mm round hole Admissible torque on plastic hex nut is 1.2Nm	(2) Solder pins 0.5mmx1.1mm
Terminals	Solderable only, 4mmx0.5mm (850) Solderable or 2.8mm quick connect - fits 0.5mm tab (851)	
Protection Class & Category	IP 40 (with Cap 855 acc. to IEC 60529) IP 54 (with Cap 856 acc. to IEC 60529) PC2 (IEC 60127-6)	
Operating Temp.	-40°C to +85°C	
Climatic Test	-40°C/+85°C/21 days (IEC 60068-2-1...3)	
Stock Conditions	0°C to 60°C, Max 70% R.H.	
Contact Resistance	≤ 5mΩ at 20mV	
Impulse Voltage	4 kV, 50Hz, 1 min., dry	
Insulation Resistance	> 10 ³ MΩ (500VDC, 1 min.)	
Solderability	350°C/2 sec. acc to IEC 60068-2-20, Test Ta, method 2	235°C/2 sec. acc to IEC 60068-2-20, Test Tb, method 1
Soldering Heat Resistance	350°C/10 sec. acc to IEC 60068-2-20, Test Tb, method 2	260°C/10 sec. acc to IEC 60068-2-20, Test Tb, method 1A
Minimum Cross Section	Conductor - 1.5mm ²	Conducting path - 0.2mm ²
Marking	Part No., 250V, Approvals	
Unit Weight	4.1g (850) / 1.8g (855)	3.2g (852) / 1.8g (855)
	4.2g (851) / 1.9g (856)	3.2g (853) / 1.9g (856)

Dimensions

850 Series

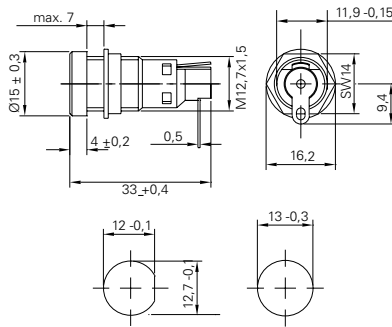

851 Series

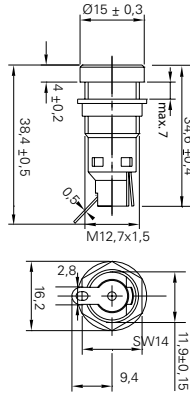

852/853 Series

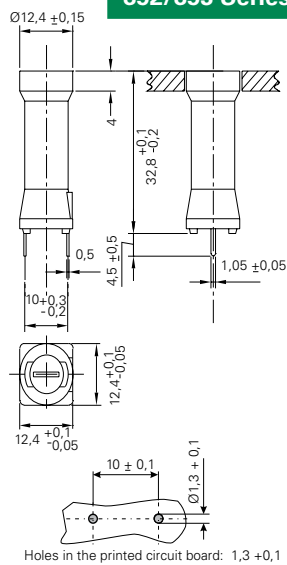

855 Cap

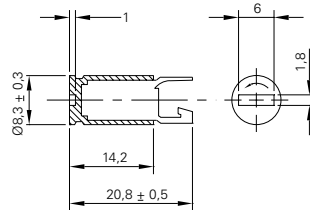

856 Cap

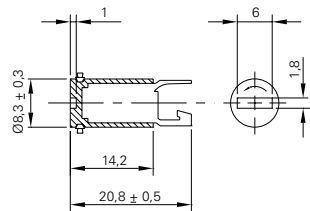

Ordering Information

Description	Ordering Number	Packaging
Cap, w/out ring (IP40)	855 0000 1009	Bulk 100
Cap, w/silicon ring (IP54)	856 0000 1009	Bulk 100
850 Series Holder (IP40)	850 0000 1009	Bulk 100
851 Series Holder (IP54)	851 0000 1009	Bulk 100
852 Series Holder (IP40)	852 0000 1009	Bulk 100
853 Series Holder (IP54)	853 0000 1009	Bulk 100