

THIS DRAWING IS UNPUBLISHED. RELEASED FOR PUBLICATION
 © COPYRIGHT - By - ALL RIGHTS RESERVED.

LOC	DIST	REVISIONS			
P	LTR	DESCRIPTION	DATE	DWN	APVD
G	14	S2	REVISED PER ECO-11-004587	11MAR11	RK HMR

AMP WIRE RANGE	Listed	LR7189 Certified
16-14 AWG SOLID OR STRANDED	16-14 AWG SOLID OR STRANDED	16-14 AWG SOLID OR STRANDED

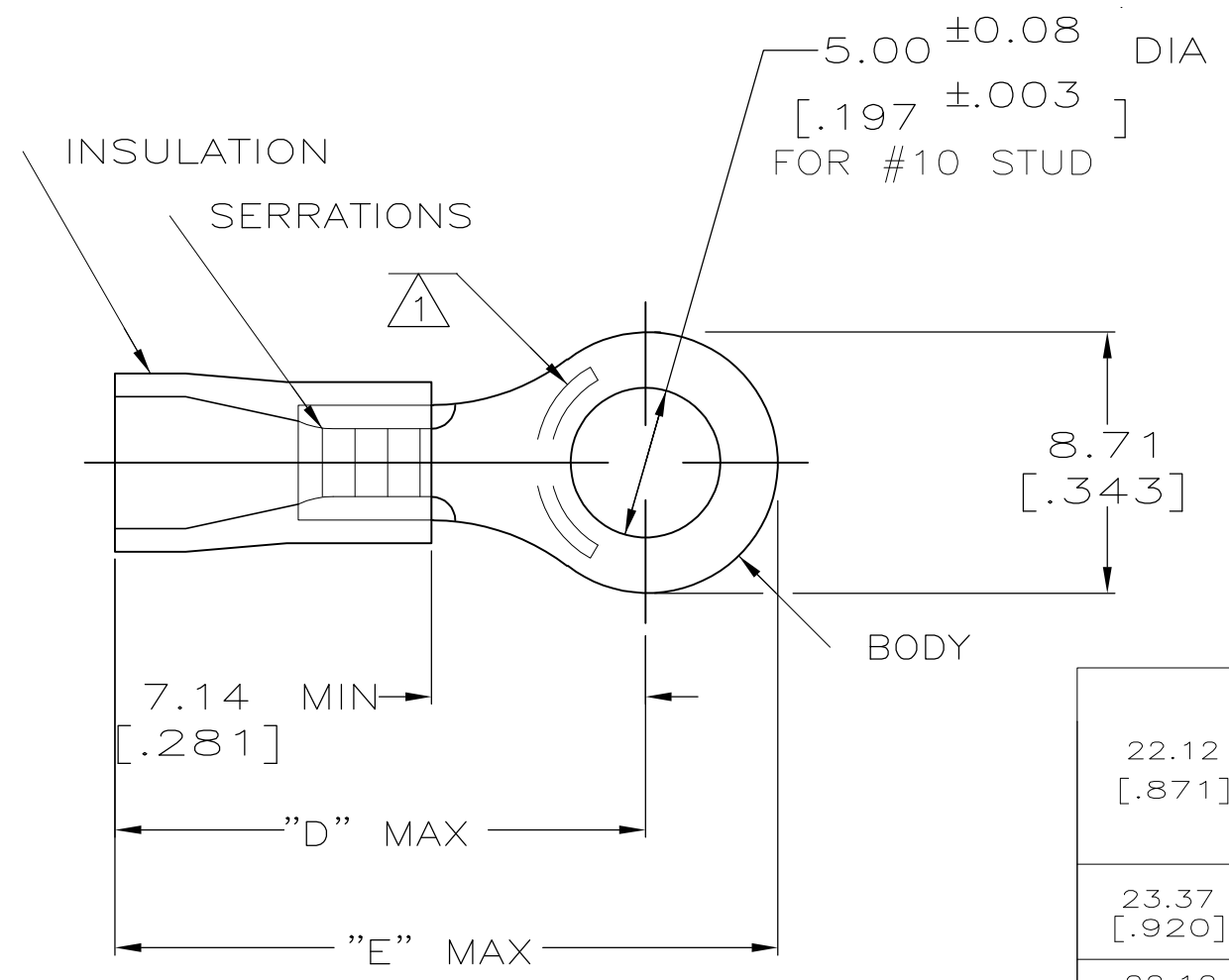

- 1 STAMP AMP 16-14* APPROX AS SHOWN
- 2 TONGUE MATERIAL THK: 0.79^{±0.05} [.031^{±.002}]
- 3 MATERIAL: BODY - CU PER ASTM B152
SLEEVE - PVC, COLOR - BLUE

"E"	"D"	WIRE INSULATION DIA	QTY	PACKAGE TYPE	PART NUMBER
22.12 [.871]	17.70 [.697]	3.00-4.90 [.118-.193]	50	LOOSE PC, BAG	8-34161-5
			5	LOOSE PC, BLS	8-34161-4
			100	LOOSE PC, BOX	8-34161-1
23.37 [.920]	18.95 [.746]	3.81-6.35 [.150-.250]	5000	ON TAPE, REEL	2-34161-3
			1000	LOOSE PIECE	2-34161-2
22.12 [.871]	17.70 [.697]	3.00-4.90 [.118-.193]	5000	ON TAPE, REEL	2-34161-1
			1000	LOOSE PIECE	34161

AMP INCORPORATED
CUSTOMER SERVICE SYSTEMS

FOR ADDITIONAL PRODUCT INFORMATION OR COPIES OF DRAWINGS AND TECHNICAL DOCUMENTS
 PRODUCT INFORMATION CENTER
 1-800-522-6752

FOR APPLICATION TOOLING INFORMATION
 TOOLING ASSISTANCE CENTER
 1-800-722-1111

FOR ORDER ENTRY
 1-800-526-5142

MAX RECOMMENDED OPERATING TEMPERATURE:
 105°C [221° F]

VOLTAGE RATING:
 N/A

CIRCULAR MIL AREA:
 1.04-2.62mm² [2,050-5,180]
 SOLID OR STRANDED

THIS DRAWING IS A CONTROLLED DOCUMENT.

DIMENSIONS: MM [INCHES]

TOLERANCES UNLESS OTHERWISE SPECIFIED:

0 PLC ± -
 1 PLC ± -
 2 PLC ± 0.20[.008]
 3 PLC ± -
 4 PLC ± -
 ANGLES ± -

MATERIAL: TIN PER ASTM B545

DWN DK SCHRUM 08/06/92
 CHK RE HERSEY 11/10/92
 APVD M ELLIS 11/10/92
 PRODUCT SPEC
 UL 486A
 APPLICATION SPEC
 NOT AVAILABLE
 WEIGHT -

STE TE Connectivity

NAME: TERMINAL, RING TONGUE, PLASTI-GRIP, WIRE SIZE, 16-14 AWG

SIZE: A3 CAGE CODE: 00779 DRAWING NO: C-34161 RESTRICTED TO: -

CUSTOMER DRAWING SCALE: 4:1 SHEET: 1 OF 1 REV: S2

Mouser Electronics

Authorized Distributor

Click to View Pricing, Inventory, Delivery & Lifecycle Information:

[TE Connectivity:](#)

[2-34161-1](#)