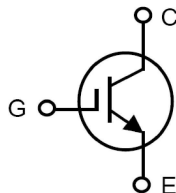


# 1200V XPT™ GenX4™ IGBT

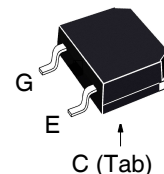
# IXYT55N120A4HV

$V_{CES} = 1200V$   
 $I_{C110} = 55A$   
 $V_{CE(sat)} \leq 1.8V$   
 $t_{fi(typ)} = 270ns$

Ultra Low-Vsat PT IGBT for  
up to 5kHz Switching



TO-268HV  
(IXYT..HV)



G = Gate      C = Collector  
 E = Emitter    Tab = Collector

Symbol	Test Conditions	Maximum Ratings	
$V_{CES}$	$T_J = 25^\circ C$ to $175^\circ C$	1200	V
$V_{CGR}$	$T_J = 25^\circ C$ to $175^\circ C$ , $R_{GE} = 1M\Omega$	1200	V
$V_{GES}$	Continuous	$\pm 20$	V
$V_{GEM}$	Transient	$\pm 30$	V
$I_{C25}$	$T_C = 25^\circ C$	175	A
$I_{C110}$	$T_C = 110^\circ C$	55	A
$I_{CM}$	$T_C = 25^\circ C$ , 1ms	350	A
<b>SSOA</b> <b>(RBSOA)</b>	$V_{GE} = 15V$ , $T_{VJ} = 125^\circ C$ , $R_G = 5\Omega$ Clamped Inductive Load	$I_{CM} = 110$ $V_{CE} \leq 0.8 \cdot V_{CES}$	A
$P_C$	$T_C = 25^\circ C$	650	W
$T_J$		-55 ... +175	$^\circ C$
$T_{JM}$		175	$^\circ C$
$T_{stg}$		-55 ... +175	$^\circ C$
$T_{SOLD}$	Plastic Body for 10s	260	$^\circ C$
<b>Weight</b>		4	g

## Features

- Optimized for Low Conduction Losses
- Positive Thermal Coefficient of  $V_{ce(sat)}$
- International Standard Package

## Advantages

- High Power Density
- Low Gate Drive Requirement

## Applications

- Power Inverters
- UPS
- Motor Drives
- SMPS
- PFC Circuits
- Battery Chargers
- Welding Machines
- Lamp Ballasts
- Inrush Current Protector Circuits

Symbol	Test Conditions ( $T_J = 25^\circ C$ , Unless Otherwise Specified)	Characteristic Values		
		Min.	Typ.	Max.
$BV_{CES}$	$I_C = 250\mu A$ , $V_{GE} = 0V$	1200		V
$V_{GE(th)}$	$I_C = 250\mu A$ , $V_{CE} = V_{GE}$	4.0		6.5 V
$I_{CES}$	$V_{CE} = V_{CES}$ , $V_{GE} = 0V$ $T_J = 150^\circ C$			5 $\mu A$ 2.5 mA
$I_{GES}$	$V_{CE} = 0V$ , $V_{GE} = \pm 20V$			$\pm 100$ nA
$V_{CE(sat)}$	$I_C = 55A$ , $V_{GE} = 15V$ , Note 1 $T_J = 150^\circ C$		1.5 1.8	V V

Symbol	Test Conditions ( $T_J = 25^\circ\text{C}$ Unless Otherwise Specified)	Characteristic Values		
		Min.	Typ.	Max.
$g_{fs}$	$I_C = 55\text{A}, V_{CE} = 10\text{V}$ , Note 1	22	36	S
$C_{ies}$	$V_{CE} = 25\text{V}, V_{GE} = 0\text{V}, f = 1\text{MHz}$		2150	pF
$C_{oes}$			125	pF
$C_{res}$			80	pF
$Q_{g(on)}$	$I_C = 55\text{A}, V_{GE} = 15\text{V}, V_{CE} = 0.5 \cdot V_{CES}$		110	nC
$Q_{ge}$			17	nC
$Q_{gc}$			56	nC
$t_{d(on)}$	<b>Inductive load, <math>T_J = 25^\circ\text{C}</math></b> $I_C = 40\text{A}, V_{GE} = 15\text{V}$ $V_{CE} = 0.5 \cdot V_{CES}, R_G = 5\Omega$ Note 2		23	ns
$t_{ri}$			35	ns
$E_{on}$			2.3	mJ
$t_{d(off)}$			300	ns
$t_{fi}$			270	ns
$E_{off}$			5.3	mJ
$t_{d(on)}$	<b>Inductive load, <math>T_J = 150^\circ\text{C}</math></b> $I_C = 40\text{A}, V_{GE} = 15\text{V}$ $V_{CE} = 0.5 \cdot V_{CES}, R_G = 5\Omega$ Note 2		21	ns
$t_{ri}$			33	ns
$E_{on}$			3.8	mJ
$t_{d(off)}$			380	ns
$t_{fi}$			530	ns
$E_{off}$			8.8	mJ
$R_{thJC}$				0.23 $^\circ\text{C/W}$

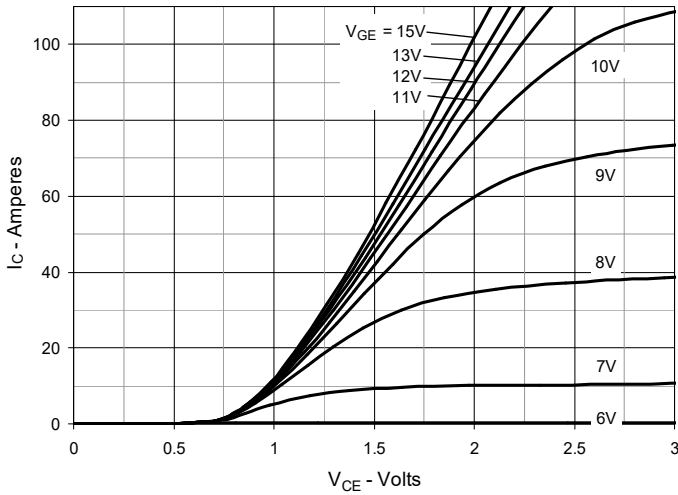
**Notes:**

1. Pulse test,  $t \leq 300\mu\text{s}$ , duty cycle,  $d \leq 2\%$ .
2. Switching times & energy losses may increase for higher  $V_{CE}$  (clamp),  $T_J$  or  $R_G$ .

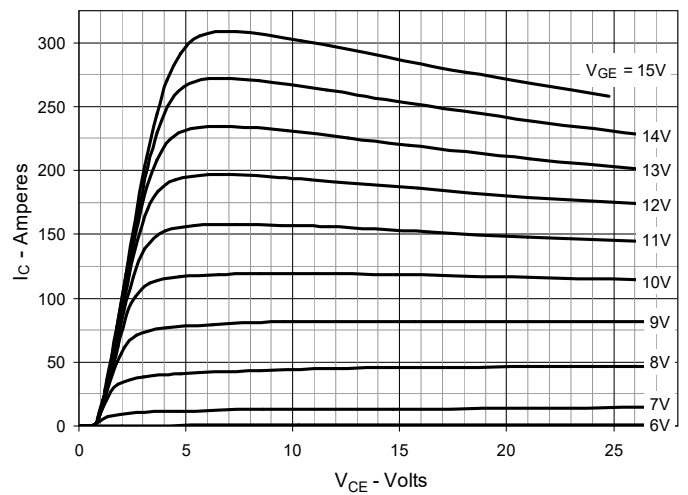
Littelfuse Reserves the Right to Change Limits, Test Conditions, and Dimensions.

IXYS MOSFETs and IGBTs are covered	4,835,592	4,931,844	5,049,961	5,237,481	6,162,665	6,404,065 B1	6,683,344	6,727,585	7,005,734 B2	7,157,338B2
by one or more of the following U.S. patents:	4,860,072	5,017,508	5,063,307	5,381,025	6,259,123 B1	6,534,343	6,710,405 B2	6,759,692	7,063,975 B2	
	4,881,106	5,034,796	5,187,117	5,486,715	6,306,728 B1	6,583,505	6,710,463	6,771,478 B2	7,071,537	

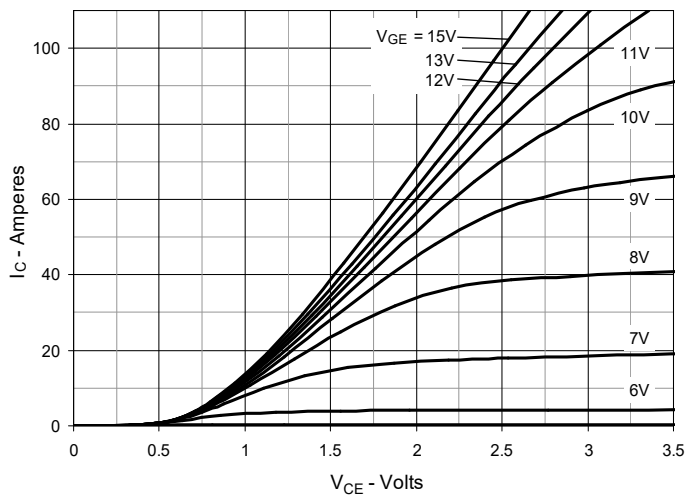
**Fig. 1. Output Characteristics @  $T_J = 25^\circ\text{C}$**



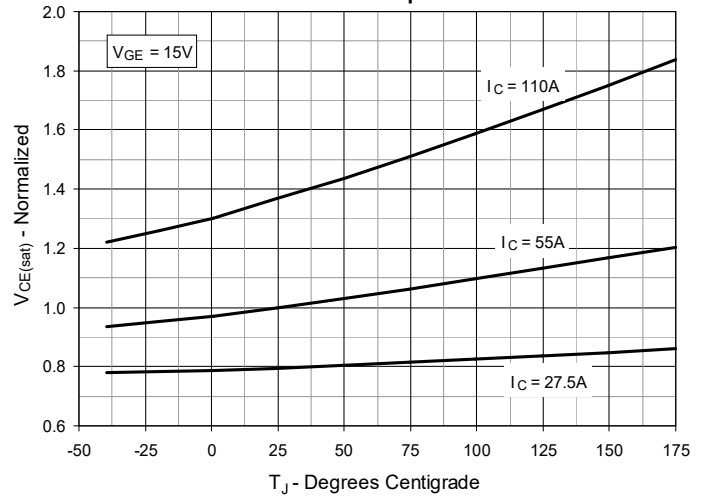
**Fig. 2. Extended Output Characteristics @  $T_J = 25^\circ\text{C}$**



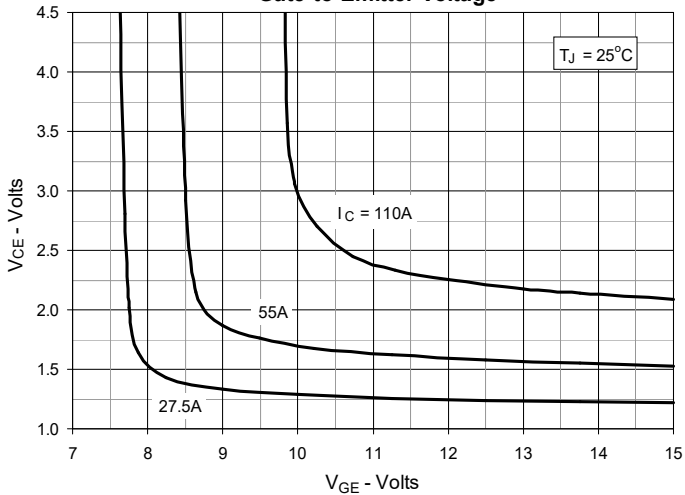
**Fig. 3. Output Characteristics @  $T_J = 150^\circ\text{C}$**



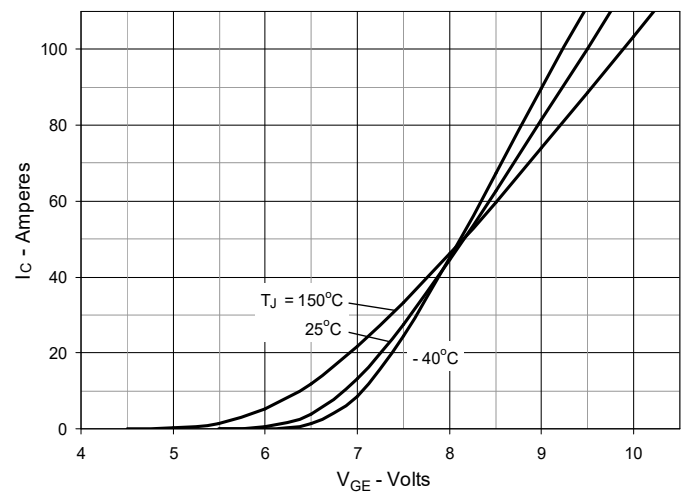
**Fig. 4. Dependence of  $V_{CE(sat)}$  on Junction Temperature**

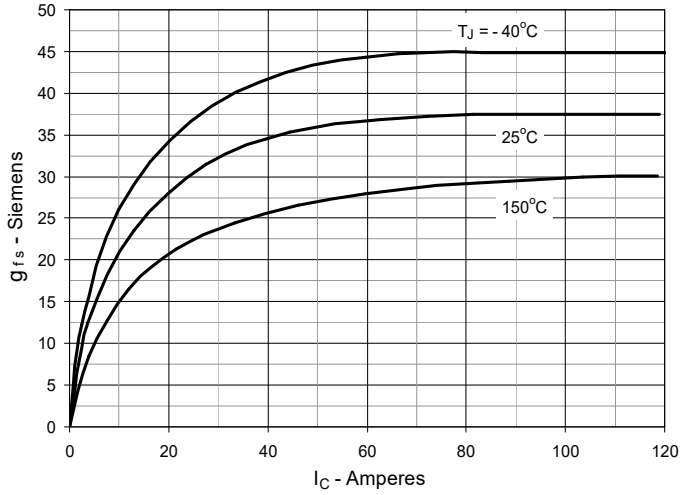
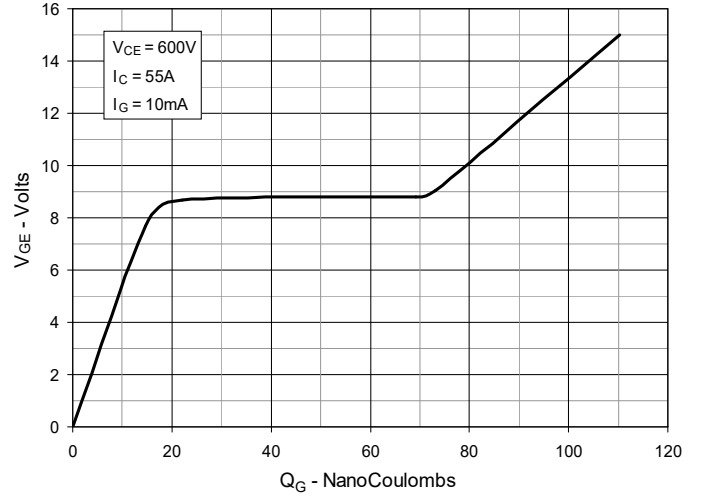
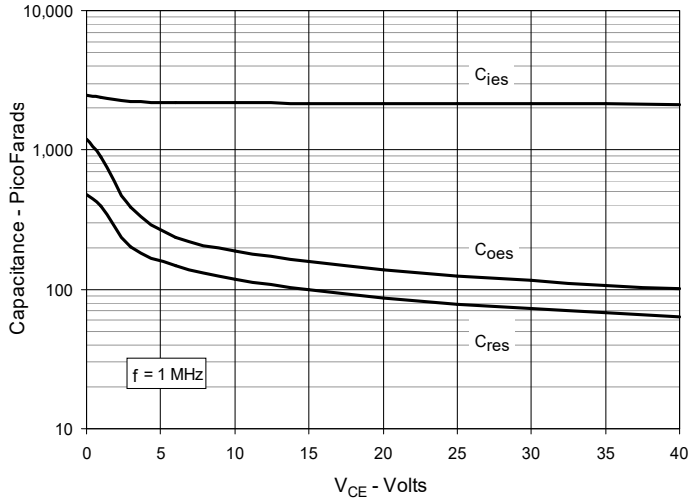
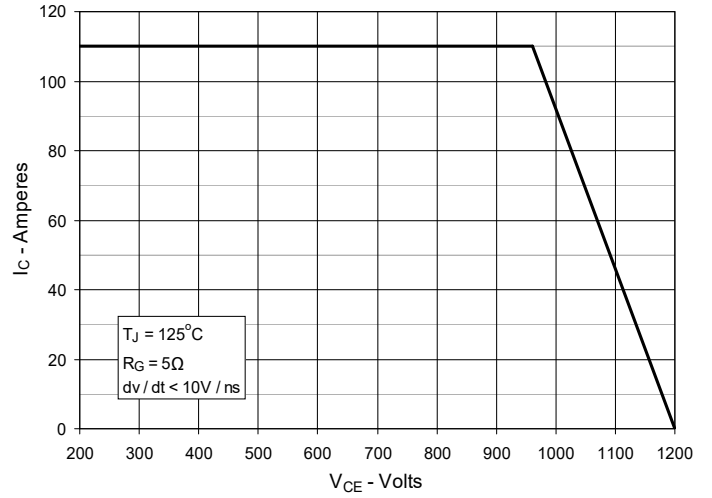
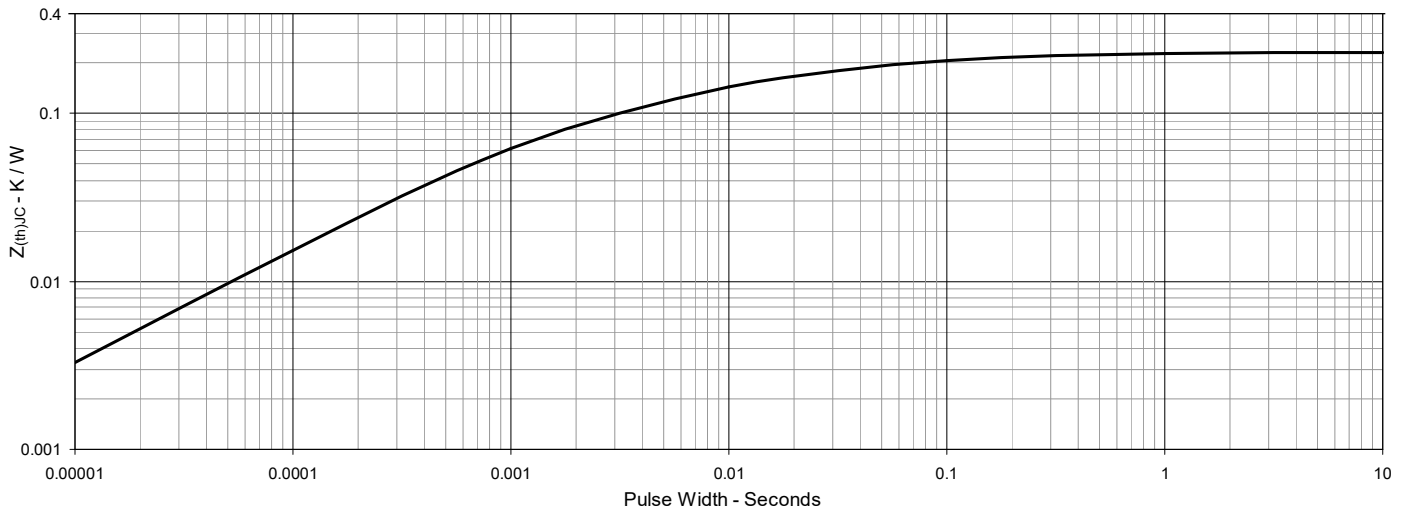


**Fig. 5. Collector-to-Emitter Voltage vs. Gate-to-Emitter Voltage**

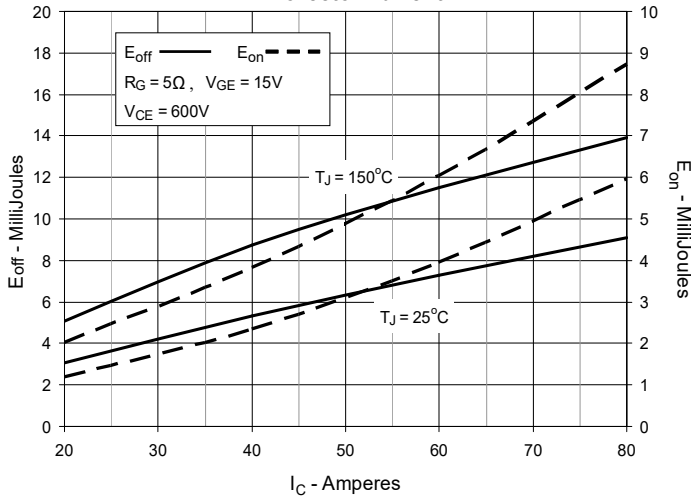


**Fig. 6. Input Admittance**

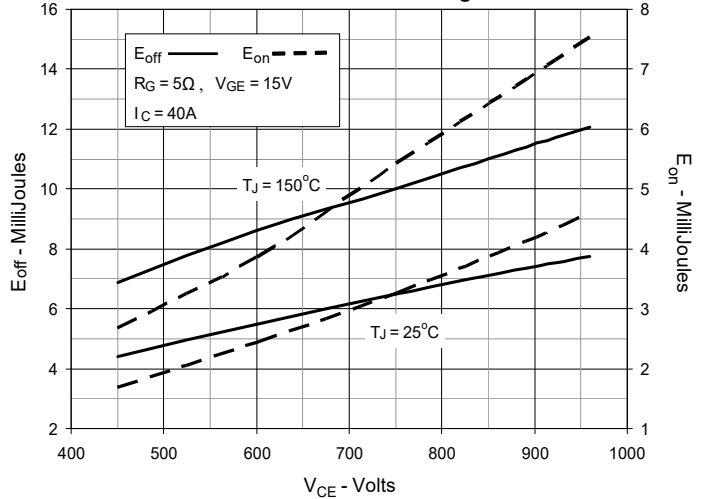


**Fig. 7. Transconductance**

**Fig. 8. Gate Charge**

**Fig. 9. Capacitance**

**Fig. 10. Reverse-Bias Safe Operating Area**

**Fig. 11. Maximum Transient Thermal Impedance**


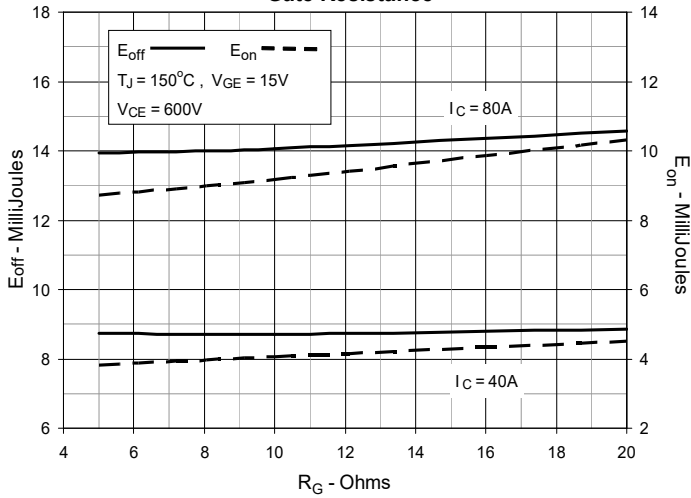
**Fig. 12. Inductive Switching Energy Loss vs. Collector Current**



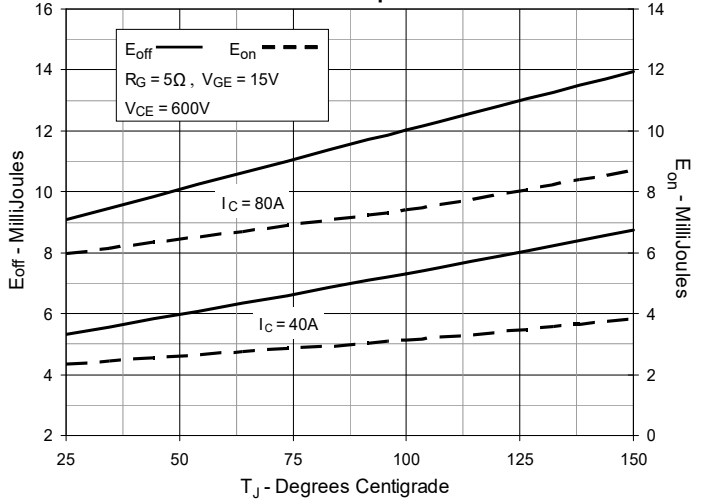
**Fig. 13. Inductive Switching Energy Loss vs. Collector-Emitter Voltage**



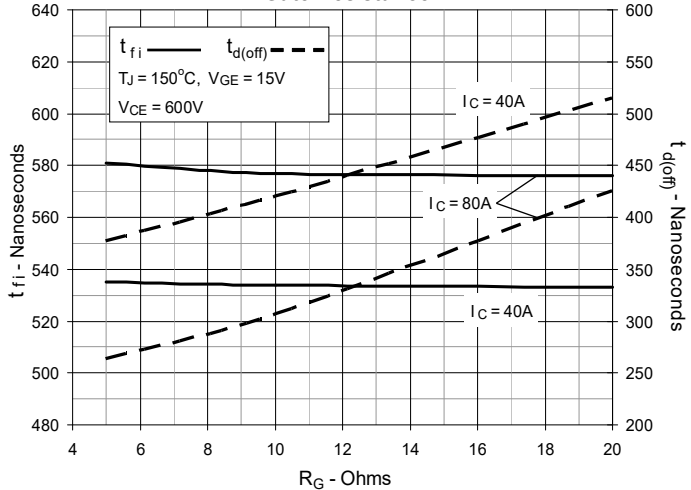
**Fig. 14. Inductive Switching Energy Loss vs. Gate Resistance**



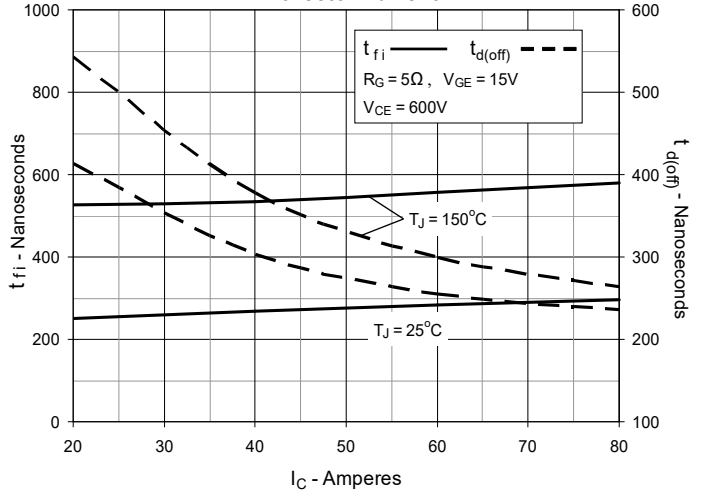
**Fig. 15. Inductive Switching Energy Loss vs. Junction Temperature**



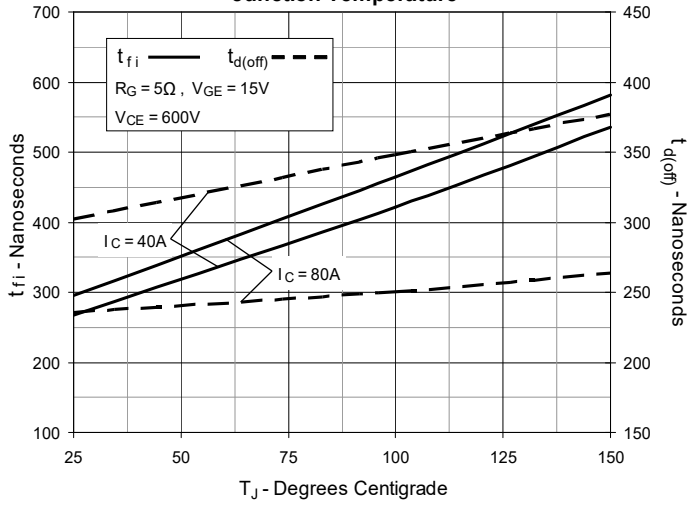
**Fig. 16. Inductive Turn-off Switching Times vs. Gate Resistance**



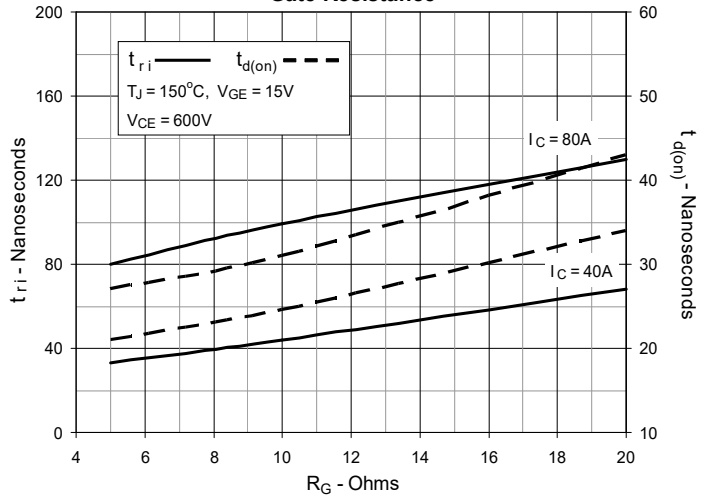
**Fig. 17. Inductive Turn-off Switching Times vs. Collector Current**



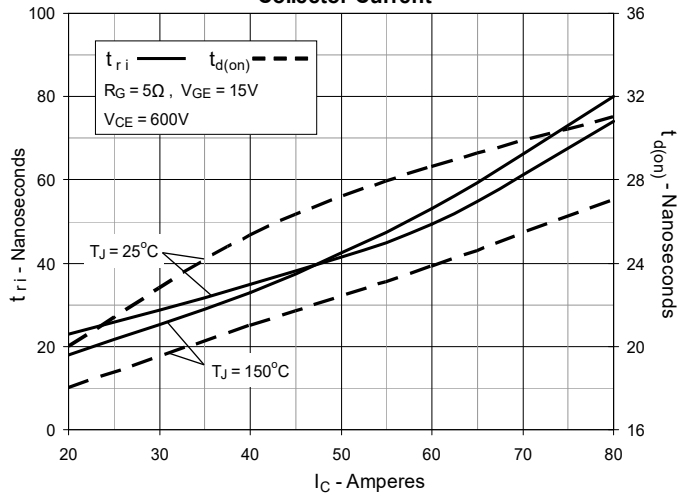
**Fig. 18. Inductive Turn-off Switching Times vs. Junction Temperature**



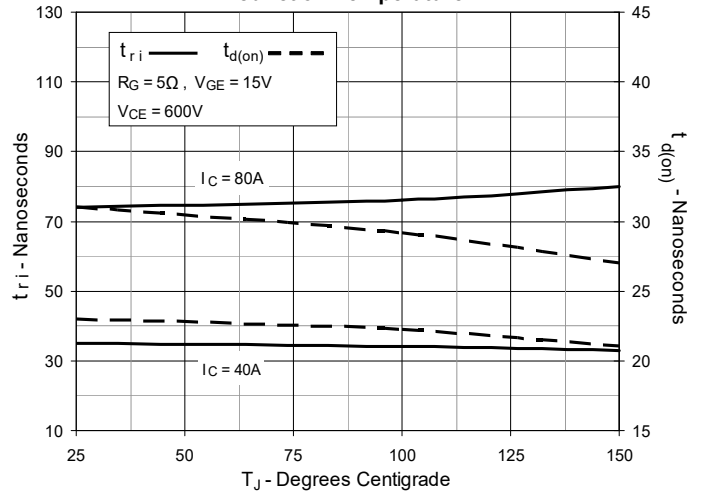
**Fig. 19. Inductive Turn-on Switching Times vs. Gate Resistance**

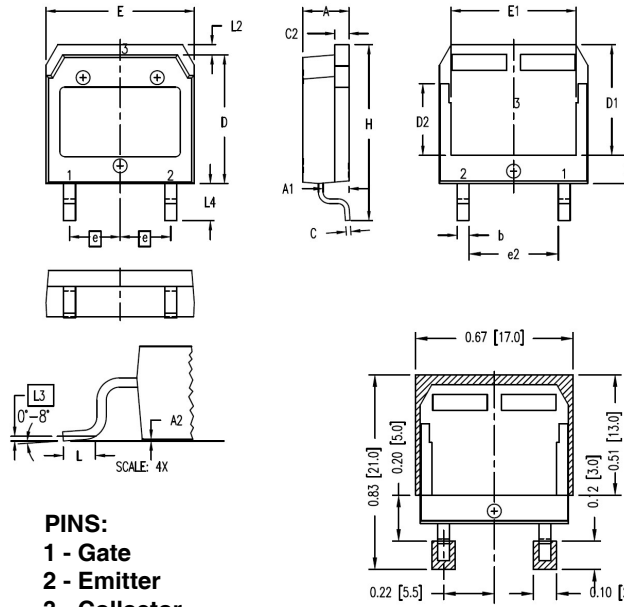


**Fig. 20. Inductive Turn-on Switching Times vs. Collector Current**



**Fig. 21. Inductive Turn-on Switching Times vs. Junction Temperature**



**TO-268HV Outline**


**PINS:**  
**1 - Gate**  
**2 - Emitter**  
**3 - Collector**

SYM	INCHES		MILLIMETER	
	MIN	MAX	MIN	MAX
A	.193	.201	4.90	5.10
A1	.106	.114	2.70	2.90
A2	.001	.010	0.02	0.25
b	.045	.057	1.15	1.45
C	.016	.026	0.40	0.65
C2	.057	.063	1.45	1.60
D	.543	.551	13.80	14.00
D1	.465	.476	11.80	12.10
D2	.295	.307	7.50	7.80
D3	.114	.126	2.90	3.20
E	.624	.632	15.85	16.05
E1	.524	.535	13.30	13.60
<b>e</b>	.215 BSC		5.45 BSC	
<b>(e2)</b>	.374	.386	9.50	9.80
H	.736	.752	18.70	19.10
L	.067	.079	1.70	2.00
L2	.039	.045	1.00	1.15
<b>L3</b>	.010 BSC		0.25 BSC	
L4	.150	.161	3.80	4.10



---

Disclaimer Notice - Information furnished is believed to be accurate and reliable. However, users should independently evaluate the suitability of and test each product selected for their own applications. Littelfuse products are not designed for, and may not be used in, all applications. Read complete Disclaimer Notice at [www.littelfuse.com/disclaimer-electronics](http://www.littelfuse.com/disclaimer-electronics).

Littelfuse Reserves the Right to Change Limits, Test Conditions, and Dimensions.

---



# Mouser Electronics

Authorized Distributor

Click to View Pricing, Inventory, Delivery & Lifecycle Information:

[IXYS:](#)

[IXYT55N120A4HV](#)