

Sn-Pb Surface Mount Ceramic Capacitors



JOHANSON DIELECTRICS - SYLMAR CALIFORNIA



Johanson Dielectrics Incorporated (JDI) is located in California's San Fernando Valley and has over 30 years experience supplying high quality ceramic chip capacitors to customers around the world. Our business philosophy is simple: Grow profitably by totally satisfying our customers' requirements for high quality, technologically

advanced ceramic electronic components. This means maintaining an intense focus in the areas of product development, new material technology advancements, automated manufacturing techniques and state of the art statistical process analysis and control systems. Put our experience to work for you today!



CONTENTS

Subject	Page
Sn-Pb Termination Overview	4-5
Sn-Pb SMT Multi-layer Ceramic Capacitors 10 - 200 VDC	6-7
Sn-Pb High Voltage Multi-layer Ceramic Capacitors 500 - 5,000 VDC	8-9
Sn-Pb High Voltage Safety Certified Chip Capacitors	10-11
Sn-Pb Large Size Chip Capacitors 50 - 5,000 VDC	12-13
Sn-Pb Tanceram [®] Multi-layer Ceramic Capacitors	14-15
Sn-Pb X2Y [®] Filter & Decoupling Capacitors	16-19
Dielectric Characteristics	20
High Reliability Testing & Part Number Breakdown	21
Packaging & Marking	22
On-line Data & Resources	23

Additional Johanson Products @ www.johansondielectrics.com

NEW Polyterm[®] Termination Capacitors
Ceramic Chip Capacitor Arrays
Ceramic Chip Capacitors, Tip & Ring 250 & 300 VDC
Ceramic Chip Capacitors, Low Inductance Ceramic Capacitors
Ceramic Chip Capacitors, High Temperature
Large Size Chip Capacitors 50 - 5,000 VDC

Additional Resources @ www.johansondielectrics.com

NEW Environmental Compliance Policy & Data
NEW On-line sample, quote, and technical information request system.
NEW Distributor Inventory Search Engine.
Part Number Cross Reference Guides
APPLICATION NOTE: Surface Mount MLCCs
APPLICATION NOTE: AC Power Handling
APPLICATION NOTE: Tantalum Replacement with MLCCs



Sn-Pb Ceramic MLCC Products



Johanson Dielectrics' tin-lead plated products are offered for high reliability, aerospace, and other applications where tin whiskering is a concern. The plating is tin lead over nickel barrier with 5% minimum lead content. The lead content of the plating in every manufacturing lot is verified using XRF method, and this data is available upon request. MIL-PRF-55681 and Hi Rel screened versions are also available.

TIN WHISKER TEST SUMMARY

In order to evaluate the tin whisker growth on pure tin and tin lead plated capacitors Johanson Dielectrics performed tin whisker testing on various sizes of capacitors using iNEMI and JESDA121 test methods.

The following samples were tested:

- 0805 X7R Pure Matte Tin Finish with nickel barrier
- 1210 X7R Pure Matte Tin Finish with nickel barrier
- 1210 X7R Tin Lead Finish with 5% minimum lead content (same lot as pure tin part)
- 1812 X7R Pure Matte Tin Finish with nickel barrier

Two different tests were performed:

1) Temperature Cycle Test: Temperature Cycle per JESD22-A104 Test Condition A Soak Mode 3 1000 cycles SEM inspections per JESD22-A121. The parts are temperature cycled from -55C to 85C, with a minimum of 10 minutes soak time at the minimum and maximum temperatures.

2) Temperature Humidity Test: 4000 hours at 60 C and 93% relative humidity per iNEMI recommendations.

Inspection of whiskers: The capacitors were inspected by SEM before and after each test at 250 and 2500 magnification.

The parts were evaluated to the requirements of Class 2 devices as stipulated by iNEMI 'Tin Whisker Acceptance Test Requirements', July 28, 2004, paragraph 18.2.3. The maximum acceptable whisker length is 40 um.

The whisker length reported is the total axial whisker length as per JEDEC standard JESD22A121 definition 3.1. Although only whiskers of 10um or greater in length are classified as 'true' whiskers as per JEDEC standard JESD22A121 definition 3.2, whiskers of all lengths are reported below.

Part Description	Number of parts tested	Maximum Whisker Length (um)		Meets iNEMI Class 2
		Temp Cycling (1000 cycles)	Temp Humidity (4000 hrs)	
0805 Pure Tin	15	4	No Whiskers Present	Yes
1210 Pure Tin	9	14	1	Yes
1812 Pure Tin	9	17	No Whiskers Present	Yes
1210 Tin Lead	9	No Whiskers Present	No Whiskers Present	Yes

Sn-Pb Ceramic MLCC Products

SN95PB5 1210 SIZE MLCC

0 Cycles, 2500X

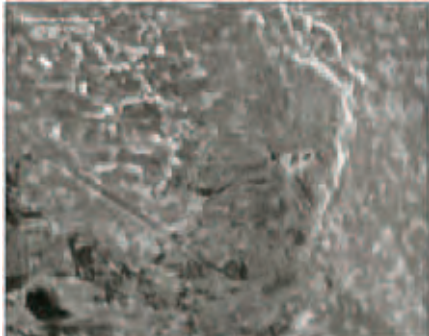

1000 Cycles, 2500X



1,000 Cycles, 250X

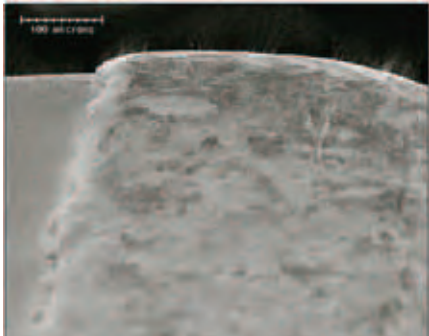

SN100 1210 SIZE MLCC

0 Cycles, 2500X

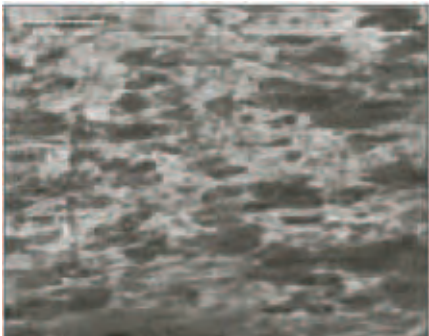

1000 Cycles, 2500X

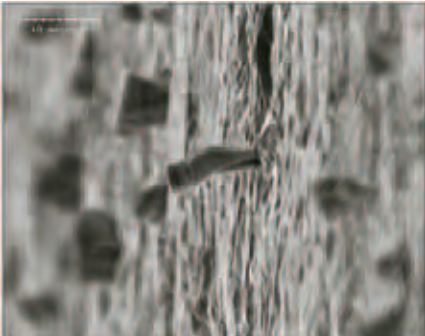

1,000 Cycles, 250X

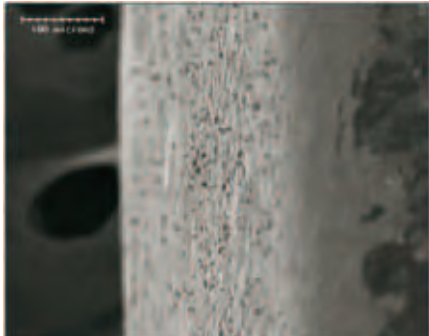

SN100 1812 SIZE MLCC

0 Cycles, 2500X

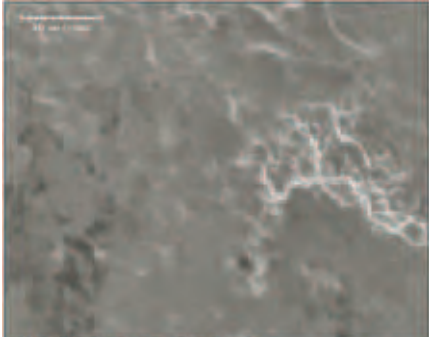

1000 Cycles, 2500X

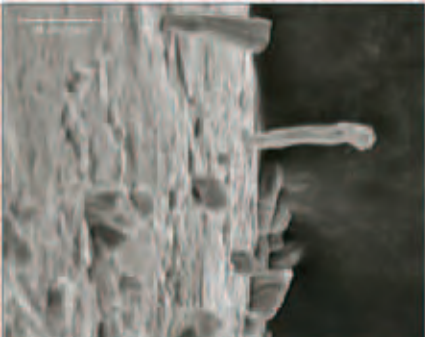

1,000 Cycles, 250X

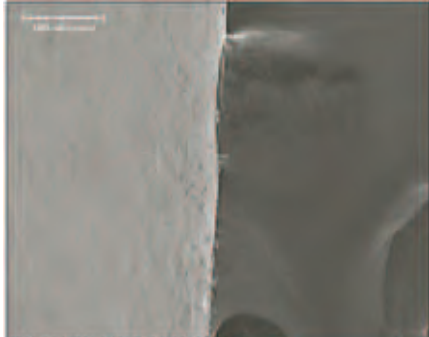

Detailed test reports are available at <http://www.johansondielectrics.com/technicalnotes/tin/>



Sn-Pb Surface Mount MLCCs 16 - 200 VDC

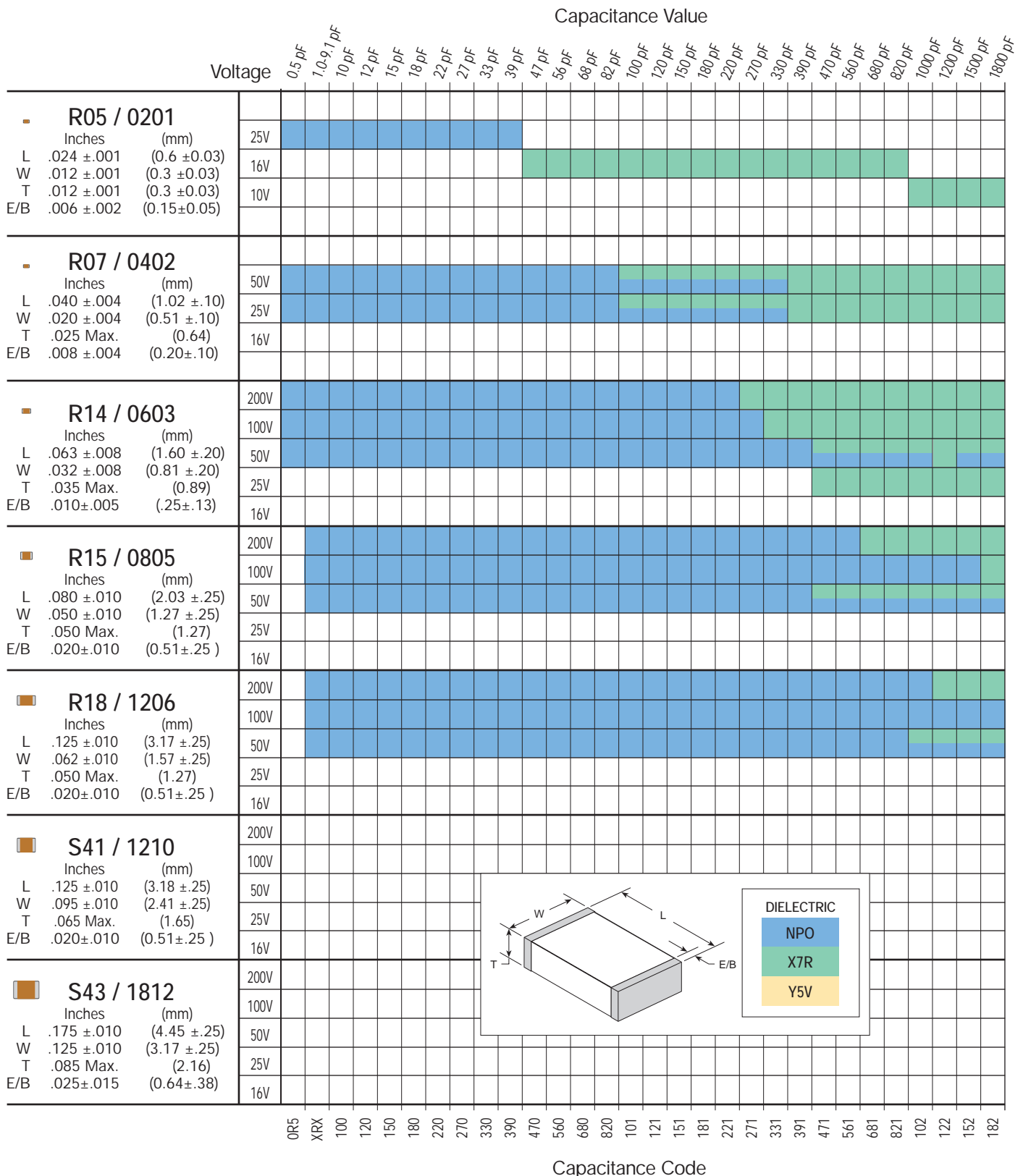

Sn-Pb Surface Mount MLCCs 16 - 200 VDC

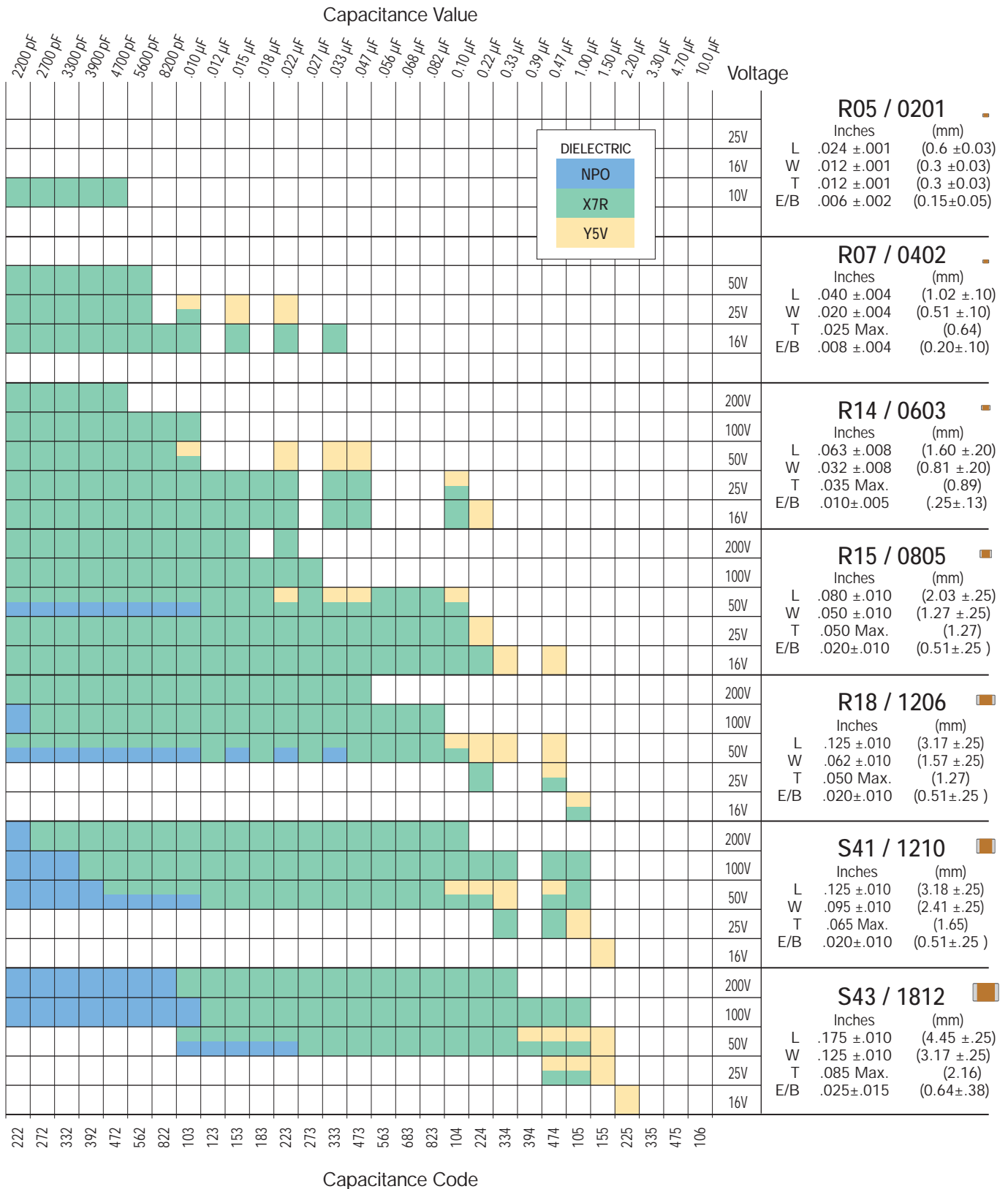

Dielectric specifications and part number breakdown may be found on pages 20 & 21.



Sn-Pb High Voltage Surface Mount MLCCs 500 - 5,000 VDC



These high voltage capacitors feature a special internal electrode design which reduces voltage concentrations by distributing voltage gradients throughout the entire capacitor. This unique design also affords increased capacitance values in a given case size and voltage rating. The capacitors are designed and manufactured to the general requirement of EIA198 and are subjected to a 100% electrical testing making them well suited for a wide variety of telecommunication, commercial, and industrial applications.

APPLICATIONS

- Analog & Digital Modems
- LAN/WAN Interface
- Lighting Ballast Circuits
- Voltage Multipliers
- DC-DC Converters
- Back-lighting Inverters

Mechanical Characteristics

Available Capacitance

			Rated Voltage	NPO Dielectric		X7R Dielectric	
				Minimum	Maximum	Minimum	Maximum
R15/0805 ■		Inches (mm)	250 VDC	-	-	1000 pF	0.022 µF
	L	.080 ±.010 (2.03 ±.25)	500 VDC	10 pF	680 pF	1000 pF	0.012 µF
	W	.050 ±.010 (1.27 ±.25)	630 VDC	10 pF	560 pF	1000 pF	3900 pF
	T	.055 Max. (1.40)	1000 VDC	10 pF	390 pF	100 pF	2200 pF
	E/B	.020 ±.010 (0.51±.25)					
R18/1206 ■		Inches (mm)	250 VDC	-	-	1000 pF	0.068 µF
	L	.125 ±.010 (3.17 ±.25)	500 VDC	10 pF	1800 pF	1000 pF	0.027 µF
	W	.062 ±.010 (1.57 ±.25)	630 VDC	10 pF	1200 pF	1000 pF	6800 pF
	T	.067 Max. (1.70)	1000 VDC	10 pF	1000 pF	100 pF	1500 pF
	E/B	.020 ±.010 (0.51±.25)	2000 VDC	10 pF	210 pF	100 pF	1000 pF
			3000 VDC	10 pF	82 pF	100 pF	120 pF
S41/1210 ■		Inches (mm)	250 VDC	-	-	1000 pF	0.12 µF
	L	.125 ±.010 (3.18 ±.25)	500 VDC	10 pF	3900 pF	1000 pF	0.047 µF
	W	.095 ±.010 (2.41 ±.25)	630 VDC	10 pF	3300 pF	1000 pF	0.027 µF
	T	.080 Max. (2.03)	1000 VDC	10 pF	2200 pF	100 pF	0.015 µF
	E/B	.020 ±.010 (0.51±.25)	2000 VDC	10 pF	560 pF	100 pF	6800 pF
			3000 VDC	10 pF	180 pF	100 pF	220 pF
R29/1808 ■		Inches (mm)	500 VDC	10 pF	3300 pF	1000 pF	0.068 µF
	L	.180 ±.010 (4.57 ±.25)	630 VDC	10 pF	2700 pF	1000 pF	0.027 µF
	W	.080 ±.010 (2.03 ±.25)	1000 VDC	1.0 pF	2200 pF	100 pF	0.018 µF
	T	.080 Max. (2.03)	2000 VDC	1.0 pF	820 pF	100 pF	6800 pF
	E/B	.020 ±.010 (0.51±.25)	3000 VDC	1.0 pF	470 pF	100 pF	3300 pF
			4000 VDC	1.0 pF	220 pF	100 pF	270 pF
			5000 VDC	1.0 pF	82 pF	100 pF	120 pF

Available capacitance values include the following significant retma values and their multiples:





1.0 1.2 1.5 1.8 2.2 2.7 3.3 3.9 4.7 5.6 6.8 8.2 (1.0 = 1.0, 10, 100, 1000, etc.)

Consult factory for non-retma values and sizes or voltages not shown.

Sn-Pb High Voltage Surface Mount MLCCs 500 - 5,000 VDC

Mechanical Characteristics

Available Capacitance

	Rated Voltage	NPO Dielectric		X7R Dielectric	
		Minimum	Maximum	Minimum	Maximum
S43 / 1812  Inches (mm) L .180 ±.010 (4.57 ±.25) W .125 ±.010 (3.17 ±.25) T .110 Max. (2.80) E/B .025 ±.015 (0.64±.38)	250 VDC	-	-	0.010 µF	0.22 µF
	500 VDC	100 pF	0.01 µF	1000 pF	0.1 µF
	630 VDC	100 pF	8200 pF	1000 pF	0.082 µF
	1000 VDC	10 pF	6800 pF	1000 pF	0.056 µF
	2000 VDC	10 pF	2200 pF	100 pF	0.010 µF
	3000 VDC	10 pF	1200 pF	100 pF	4700 pF
	4000 VDC	10 pF	560 pF	10 pF	1500 pF
	5000 VDC	10 pF	150 pF	10 pF	680 pF
S49 / 1825  Inches (mm) L .180 ±.010 (4.57 ±.25) W .250 ±.010 (6.35 ±.25) T .140 Max. (3.56) E/B .025 ±.015 (0.64±.38)	500 VDC	100 pF	0.027 µF	0.01 µF	0.33 µF
	630 VDC	100 pF	0.022 µF	0.01 µF	0.22 µF
	1000 VDC	10 pF	0.015 µF	1000 pF	0.10 µF
	2000 VDC	10 pF	5600 pF	100 pF	0.022 µF
	3000 VDC	10 pF	2200 pF	100 pF	8200 pF
	4000 VDC	10 pF	1000 pF	100 pF	2000 pF
	5000 VDC	10 pF	270 pF	100 pF	820 pF
	S47 / 2220  Inches (mm) L .225 ±.015 (5.72 ±.38) W .200 ±.015 (5.08 ±.38) T .150 Max. (3.81) E/B .025 ±.015 (0.64±.38)	500 VDC	1000 pF	0.027 µF	0.01 µF
630 VDC		1000 pF	0.027 µF	0.01 µF	0.27 µF
1000 VDC		100 pF	0.018 µF	1000 pF	0.12 µF
2000 VDC		100 pF	6800 pF	1000 pF	0.022 µF
3000 VDC		10 pF	2700 pF	100 pF	0.01 µF
4000 VDC		10 pF	1200 pF	100 pF	2200 pF
5000 VDC		10 pF	390 pF	100 pF	1000 pF
S48 / 2225  Inches (mm) L .225 ±.010 (5.72 ±.25) W .255 ±.015 (6.48 ±.38) T .150 Max. (3.81) E/B .025 ±.015 (0.64±.38)		500 VDC	1000 pF	0.033 µF	0.01 µF
	630 VDC	1000 pF	0.027 µF	0.01 µF	0.33 µF
	1000 VDC	100 pF	0.022 µF	1000 pF	0.15 µF
	2000 VDC	100 pF	8200 pF	1000 pF	0.039 µF
	3000 VDC	10 pF	4700 pF	100 pF	0.01 µF
	4000 VDC	10 pF	2200 pF	100 pF	3900 pF
	5000 VDC	10 pF	680 pF	100 pF	1500 pF

Available capacitance values include the following significant retma values and their multiples: 1.0 1.2 1.5 1.8 2.2 2.7 3.3 3.9 4.7 5.6 6.8 8.2 (1.0 = 1.0, 10, 100, 1000, etc.) Consult factory for non-retma values and sizes or voltages not shown.

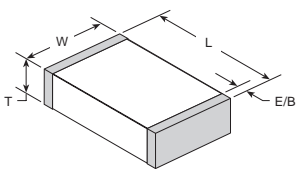

ELECTRICAL CHARACTERISTICS

Meets the standard NPO & X7R dielectric specifications listed on page 20

Dielectric Withstanding Voltage DWV = 750 VDC for 500 WVDC rated units,
 DWV = 945 VDC for 630 WVDC rated units,
 DWV = 1.2 X rated WVDC for ratings ≥ 1,000 WVDC

NOTE: Capacitors may require a surface coating to prevent external arcing.

HOW TO ORDER

202	R29	N	101	K	T	4	E															
VOLTAGE 501 = 500 V 631 = 630 V 102 = 1000 V 202 = 2000 V 302 = 3000 V 402 = 4000 V 502 = 5000 V	CASE SIZE See Chart	DIELECTRIC N = NPO/COG W = X7R	CAPACITANCE 1st two digits are significant; third digit denotes number of zeros, R = decimal. 1R0 = 1.0 pF 101 = 100 pF	TOLERANCE NPO: J = ± 5% K = ± 10% X7R: K = ± 10% M = ± 20%	TERMINATION T = Tin-Lead w/ 5% min. Pb MARKING 4 = Unmarked 6 = EIA "J" Code*	TAPE MODIFIER <table border="1"> <thead> <tr> <th>Code</th> <th>Tape</th> <th>Reel</th> </tr> </thead> <tbody> <tr> <td>E</td> <td>Embossed</td> <td>7"</td> </tr> <tr> <td>U</td> <td>Embossed</td> <td>13"</td> </tr> <tr> <td>T</td> <td>Paper</td> <td>7"</td> </tr> <tr> <td>R</td> <td>Paper</td> <td>13"</td> </tr> </tbody> </table> Tape specs. per EIA RS481		Code	Tape	Reel	E	Embossed	7"	U	Embossed	13"	T	Paper	7"	R	Paper	13"
Code	Tape	Reel																				
E	Embossed	7"																				
U	Embossed	13"																				
T	Paper	7"																				
R	Paper	13"																				
Part number written: 202R29N101KT4E																						



Sn-Pb Safety Certified Capacitors

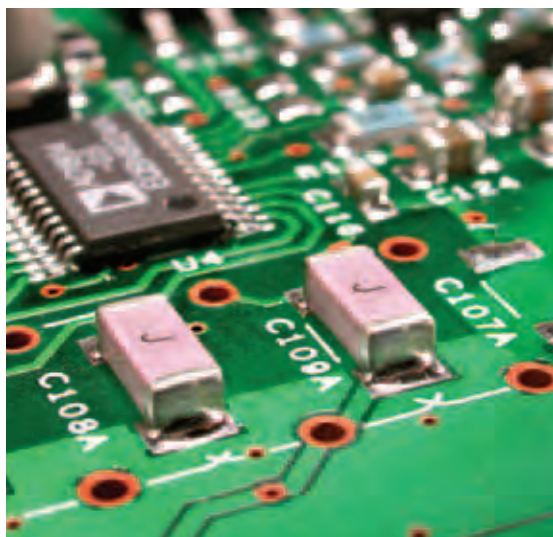

Johanson Dielectrics Type SC ceramic chip capacitors are designed for AC voltage surge and lightning protection in line-to-ground interface applications in computer network, modem, facsimile and other equipment.

Johanson's safety capacitor offering includes four different case sizes and NPO and X7R dielectric materials.

These devices are surface mount ready with barrier terminations and tape and reel packaging.

Additional information on capacitor safety ratings may be found below. Specific certification details may be found under each product listing on the facing page.

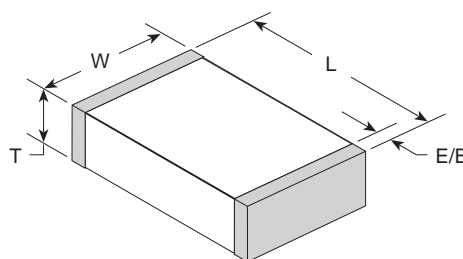

SAFETY RATING	VOLTAGE RATING	WITHSTANDING VOLTAGE	IMPULSE VOLTAGE	CASE SIZE	JOHANSON ORDERING P/N
X2/Y3	250 VAC	1,500 VAC	2,500 V	1808	302R29____V_E-****-SC
Y3	250 VAC	1,500 VAC	N/A	1812	302S43____V_E-****-SC
X1/Y2	250 VAC	1,500 VAC	5,000 V	1808	502R29____V_E-****-SC
Y2	250 VAC	1,500 VAC	5,000 V	2211	502R30____V_E-****-SC
X1/Y2	250 VAC	1,500 VAC	5,000 V	2220	502S47____V3E-****-SC

X Capacitors are defined as suitable for use in situations where failure of the capacitor would not lead to danger of electric shock.

Y Capacitors are defined as suitable for use in situations where failure of the capacitor could lead to danger of electric shock.

HOW TO ORDER SAFETY CERTIFIED

302	R29	N	101	K	T	3	E - ***** -	SC						
IMPULSE VOLTAGE 302 = 3000V 502 = 5000V	SIZE See Size Chart	DIELECTRIC N = NPO W = X7R	CAPACITANCE 1st two digits are significant; third digit denotes number of zeros; 101 = 100 pF	TOLERANCE NPO: J = ±5% K = ±10% X7R: K = ±10% M = ±20%	TERMINATION T = Tin-Lead w/ 5% min. Pb	MARKING 3 = Special (J) 4 = No marking	TAPE MODIFIER <table border="1" style="font-size: small; width: 100%;"> <tr> <th>Code</th> <th>Tape</th> <th>Reel</th> </tr> <tr> <td>E</td> <td>Embossed</td> <td>7"</td> </tr> </table> Tape specifications conform to EIA RS481	Code	Tape	Reel	E	Embossed	7"	TYPE SC = Safety Certified
Code	Tape	Reel												
E	Embossed	7"												

P/N written: 302R29N101KT3E-****-SC

Sn-Pb Safety Certified Capacitors

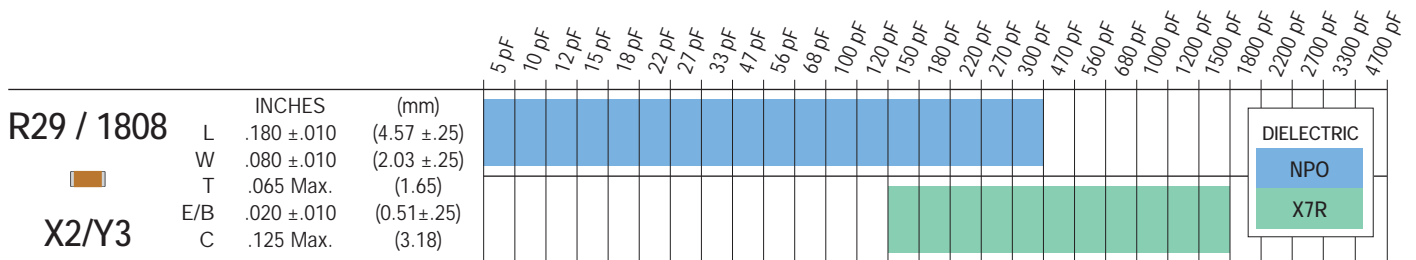

TUV Rheinland Certificate Numbers 2172792 & 2172793 Standards: EN132400:1994+A1, IEC 60384-14:1993+A1, EN 60950:1992+A1+A2+A3+A4+A11
 UL File Number E212609 Standards:UL 1950, Third Edition • Semko Reference Numbers 0026092-1 & 0003222-1 Standards: EN 132400:1994+A2:1998, IEC 60384-14, Second Edition:1993+A1:1995, Robustness of Terminations (cl 4.3) tested according to IEC 60384-1 amendment 3 cl 4.34 & 4.35, Resistance to Soldering Heat (cl 4.4) tested according to IEC 60384-1 amendment 3 cl 4.14.2, Impulse test made with 2.5KV according to clause 6.4.2.1 in IEC 60950, Creepage distance between live parts of different polarity meets the requirements in IEC 60950

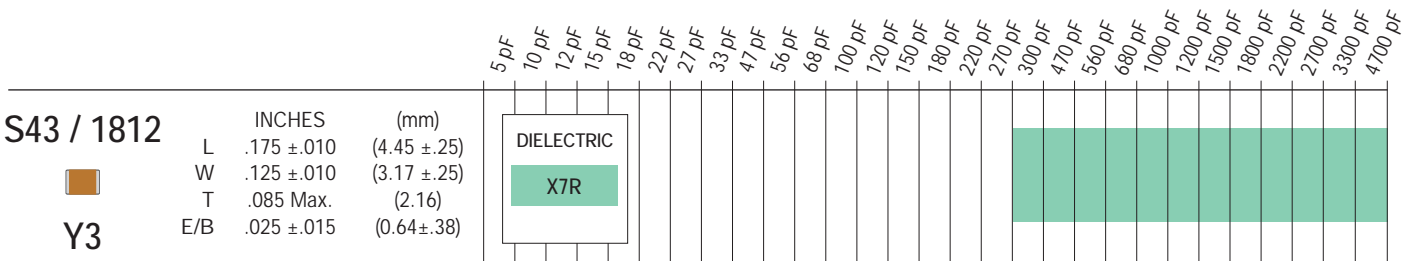

TUV Rheinland Certificate Number 2172792 Standards: EN132400:1994+A1, IEC 60384-14:1993+A1, EN 60950:1992+A1+A2+A3+A4+A11

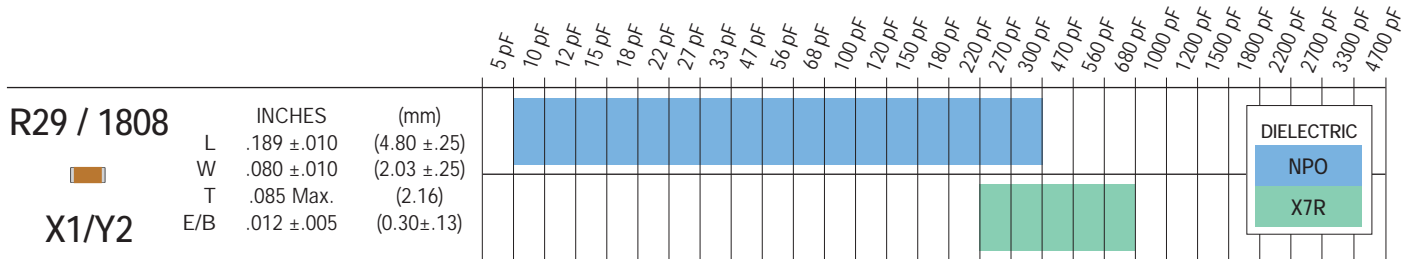

TUV Rheinland Certificate Numbers T72041313 and T72041314 Standards: EN132400:1994+A2+A3+A4, EN60950-1:2001, IEC 384-14:1993+A1

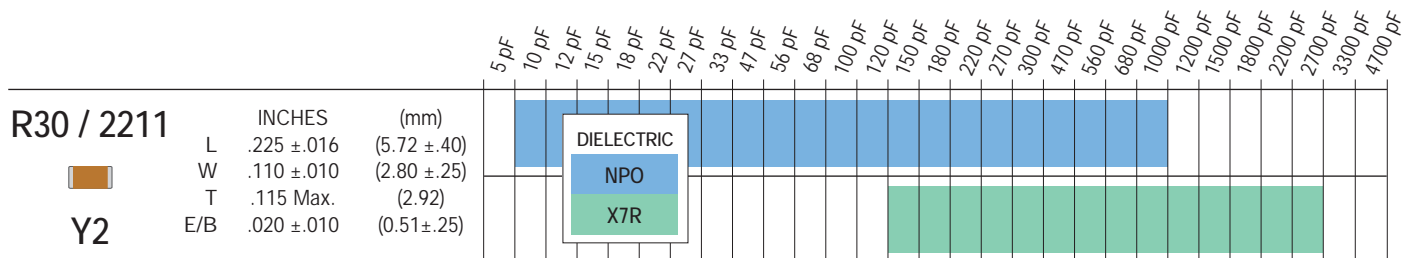

TUV Rheinland Certificate Numbers 2279224, 2172779 & 72041313 Standards: EN132400:1994+A2, IEC 60384-14:1993+A1

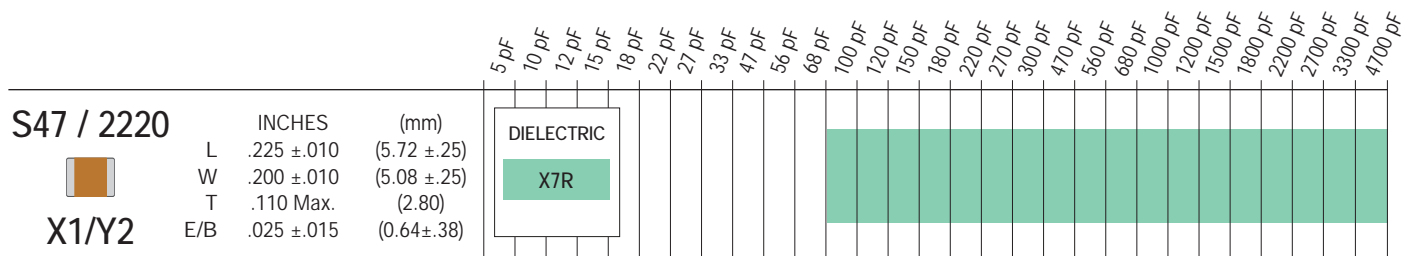

TUV Rheinland Certificate Number 2272848 Standards: IEC 60384-14:1993+A, EN 132400:1994+A2 UL File E212609 & UL60950 3rd Edition



Sn-Pb Large Size Capacitor Chips 50 - 5,000 VDC

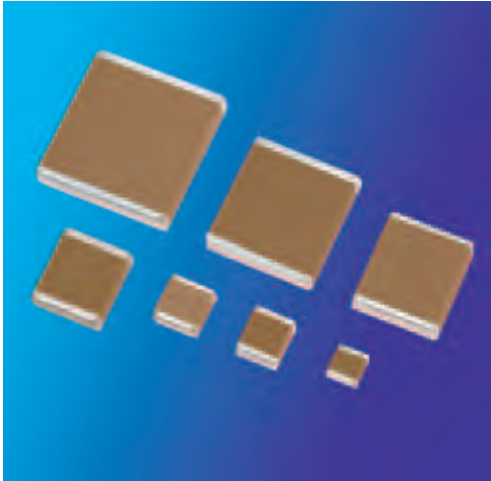



KEY FEATURES

- Rated Working Voltages from 50 to 15,000 VDC
- Low ESR Ceramic Out-performs Tantalums
- Compact MLC Designs Smaller Than Film or Disc
- MIL-PRF-55681 & Hi-Rel Screened Versions Available
- Custom Sizes, Voltages, and Values Available

APPLICATIONS

- Power Supplies
- Voltage Multipliers
- Data Isolation
- Surge Protection
- Industrial Control Circuits
- Custom Applications

MAXIMUM CAPACITANCE VS DC VOLTAGE RATING

			50 V	100 V	250 V	500 V	1K V	2K V	3K V	4K V	5K V	
S49 / 1825	 Inches (mm) L .180 ±.010 (4.57 ±.25) W .250 ±.010 (6.35 ±.25) T .140 Max. (3.56 Max) E/B .025 ±.015 (0.64±.38)	NPO	473	383	273	273	153	562	222	102	271	
		X7R	185	105	563	334	104	223	822	202	821	
S47 / 2220	 Inches (mm) L .225 ±.015 (5.72 ±.38) W .200 ±.015 (5.08 ±.38) T .150 Max. (3.81 Max) E/B .025 ±.015 (0.64±.38)	NPO	683	473	333	273	183	682	272	122	391	
		X7R	185	155	564	334	184	273	103	332	152	
S48 / 2225	 Inches (mm) L .225 ±.010 (5.72 ±.25) W .255 ±.015 (6.48 ±.38) T .150 Max. (3.81 Max) E/B .025 ±.015 (0.64±.38)	NPO	753	563	393	333	223	822	472	222	681	
		X7R	225	185	824	474	224	473	153	562	222	

Available capacitance values include the following significant retma values and their multiples:





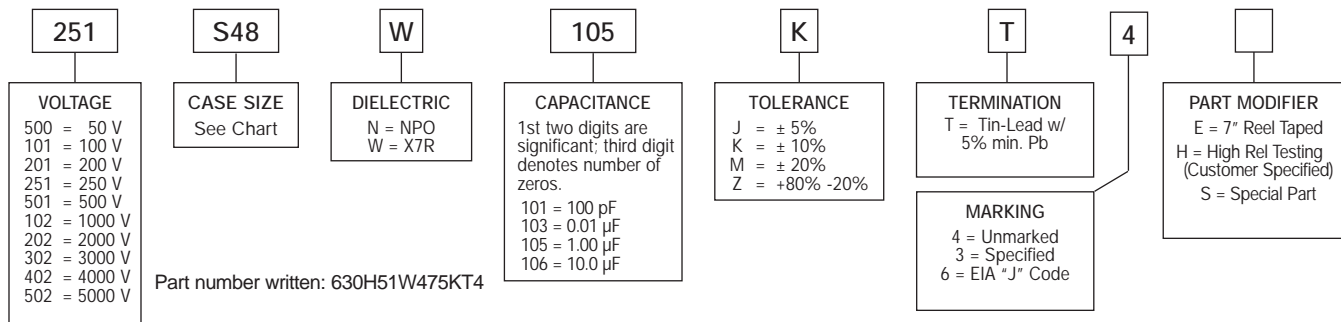

1.0 1.2 1.5 1.8 2.2 2.7 3.3 3.9 4.7 5.6 6.8 8.2 (1.0 = 1.0, 10, 100, 1000, etc.)

HOW TO ORDER



Sn-Pb Large Size Capacitor Chips 50 - 5,000 VDC

MAXIMUM CAPACITANCE VS DC VOLTAGE RATING

H42 / 1515  Inches (mm) L .150 ±.015 (3.81 ±.38) W .150 ±.015 (3.81 ±.38) T .150 Max. (3.81 Max) E/B .025 ±.015 (0.64±.38)		500 V	1K V	2K V	3K V	4K V	5K V			
	NPO	472	152	681	331	151	101			
	X7R	124	393	123	392	561	331			
H47 / 2520  Inches (mm) L .250 ±.018 (6.35 ±.46) W .200 ±.015 (5.08 ±.38) T .150 Max. (3.81 Max) E/B .025 ±.015 (0.64±.38)		500 V	1K V	2K V	3K V	4K V	5K V			
	NPO	223	332	152	681	331	221			
	X7R	394	124	273	822	222	102			
H51 / 3530  Inches (mm) L .350 ±.035 (8.89 ±.89) W .300 ±.030 (7.62 ±.76) T .200 Max (5.08 Max) E/B .025 ±.015 (0.64±.38)		500 V	1K V	2K V	3K V	4K V	5K V			
	NPO	563	472	332	152	102	471			
	X7R	824	394	104	273	682	332			
H54 / 3640  Inches (mm) L .360 ± .030 (9.14 ± .76) W .400 ± .030 (10.16 ±.76) T .200 Max (5.08 Max) E/B .025 ±.015 (0.64±.38)		50 V	100 V	250 V	500 V	1K V	2K V	3K V	4K V	5K V
	NPO	224	184	154	683	822	332	222	152	681
	X7R	565	475	225	155	564	124	333	822	392
H62 / 4540  Inches (mm) L .450 ± .045 (11.4 ±1.1) W .400 ± .040 (10.16 ±1.0) T .200 Max (5.08 Max) E/B .025 ±.015 (0.64±.38)		500 V	1K V	2K V	3K V	4K V	5K V			
	NPO	104	103	682	332	222	102			
	X7R	155	684	184	473	183	103			
H70 / 6560  Inches (mm) L .650±.065 (16.5±1.7) W .600±.060 (15.2±1.5) T .200 Max (5.08 Max) E/B .025 ±.015 (0.64±.38)		50 V	100 V	250 V	500 V	1K V	2K V	3K V	4K V	5K V
	NPO	564	474	334	224	223	153	682	472	332
	X7R	156	106	475	335	155	334	104	223	103

Available capacitance values include the following significant retma values and their multiples:
 1.0 1.2 1.5 1.8 2.2 2.7 3.3 3.9 4.7 5.6 6.8 8.2 (1.0 = 1.0, 10, 100, 1000, etc.)
 Consult factory for sizes, values, & voltages not shown.

ELECTRICAL CHARACTERISTICS

Meets the standard NPO & X7R dielectric specifications listed on page 28 & 29 except

Dielectric Withstanding Voltage DWV = 750 VDC for 500 WVDC rated units,
 DWV = 945 VDC for 630 WVDC rated units,
 DWV = 1.2 X rated WVDC for ratings ≥ 1,000 WVDC

NOTE: Circuit applications above 1KVDC may require surface coating to prevent external arcing.

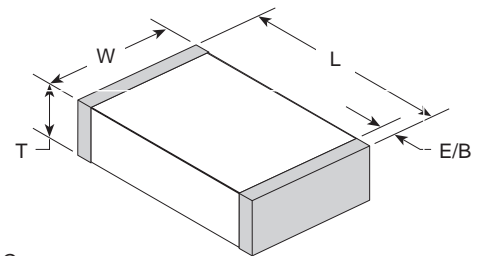

Sn-Pb Tanceram® Chip Capacitors



TANCERAM® chip capacitors can replace tantalum capacitors in many applications and offer several key advantages over traditional tantalums. Because Tanceram® capacitors exhibit extremely low ESR, equivalent circuit performance can often be achieved using considerably lower capacitance values. Low DC leakage reduces current drain, extending the battery life of portable products. Tancerams® high DC breakdown voltage ratings offer improved reliability and eliminate large voltage de-rating common when designing with tantalums.

ADVANTAGES

- Low ESR
- Higher Surge Voltage
- Reduced CHIP Size
- Higher Insulation Resistance
- Low DC Leakage
- Non-polarized Devices
- Improved Reliability
- Higher Ripple Current

APPLICATIONS

- SWITCHING POWER SUPPLY SMOOTHING (INPUT/OUTPUT)
- DC/DC Converter Smoothing (Input/Output)
- BACKLIGHTING INVERTERS
- General Digital Circuits

Typical ESR Comparison

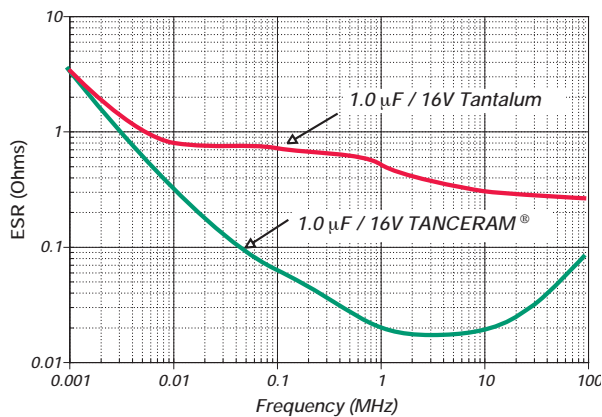

Typical Breakdown Voltage Comparison

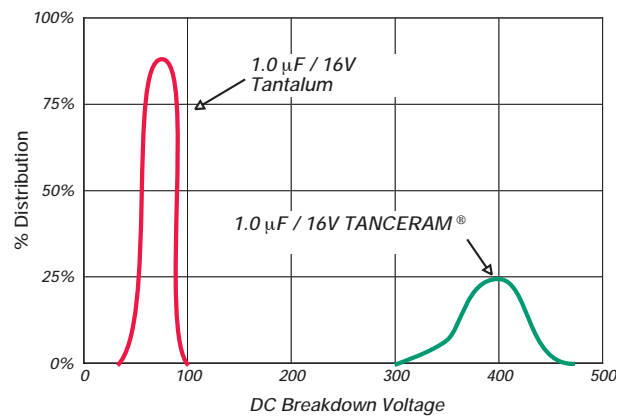

HOW TO ORDER TANCERAM®

6R3	S43	X	106	M	T	4	E									
VOLTAGE 500 = 50 V 250 = 25 V 160 = 16 V 100 = 10 V 6R3 = 6.3 V	CASE SIZE See Chart	DIELECTRIC W = X7R X = X5R Y = Y5V	CAPACITANCE 1st two digits are significant; third digit denotes number of zeros. 474 = 0.47 μF 105 = 1.00 μF	TOLERANCE Y5V Z = +80% -20% X7R/X5R K = ±10% M = ±20%	TERMINATION T = Tin-Lead w/ 5% min. Pb	MARKING 4 = Unmarked	TAPE MODIFIER <table style="font-size: small; width: 100%;"> <thead> <tr> <th>Code</th> <th>Type</th> <th>Reel</th> </tr> </thead> <tbody> <tr> <td>E</td> <td>Plastic</td> <td>7"</td> </tr> <tr> <td>T</td> <td>Paper</td> <td>7"</td> </tr> </tbody> </table> Tape specifications conform to EIA RS481	Code	Type	Reel	E	Plastic	7"	T	Paper	7"
Code	Type	Reel														
E	Plastic	7"														
T	Paper	7"														

P/N written: 6R3S43X106MT4E



Sn-Pb Tanceram® Chip Capacitors

CAPACITANCE SELECTION

CASE SIZE			50 V	25 V	16 V	10 V	6.3 V	50 V	25 V	16 V	10 V	6.3 V	50 V	25 V	16 V	10 V	6.3 V	50 V	25 V	16 V	10 V	6.3 V	50 V	25 V	16 V	10 V	6.3 V	50 V	25 V	16 V	10 V	6.3 V	50 V	25 V	16 V	10 V	6.3 V
			.047 pF	0.10 μF	0.22 μF	0.33 μF	0.47 μF	1.0 μF	2.2 μF	3.3 μF	4.7 μF	10 μF	22 μF	47 μF	100 μF																						
0402 R07	L	Inches	(mm)																																		
	W	.040 ±.004	(1.02 ±.10)																																		
	T	.020 ±.004	(0.51 ±.10)																																		
	E/B	.025 Max.	(0.64)																																		
	E/B	.008 ±.004	(0.20±.10)																																		
0603 R14	L	Inches	(mm)																																		
	W	.063 ±.008	(1.60 ±.20)																																		
	T	.032 ±.008	(0.81 ±.20)																																		
	E/B	.035 Max.	(0.89)																																		
	E/B	.010±.005	(.25±.13)																																		
0805 R15	L	Inches	(mm)																																		
	W	.080 ±.010	(2.03 ±.25)																																		
	T	.050 ±.010	(1.27 ±.25)																																		
	E/B	.060 Max.	(1.52)																																		
	E/B	.020±.010	(0.51±.25)																																		
1206 R18	L	Inches	(mm)																																		
	W	.125 ±.010	(3.17 ±.25)																																		
	T	.062 ±.010	(1.57 ±.25)																																		
	E/B	.070 Max.	(1.78)																																		
	E/B	.020 +.015-.010	(0.51+.38-.25)																																		
1210 S41	L	Inches	(mm)																																		
	W	.125 ±.010	(3.18 ±.25)																																		
	T	.095 ±.010	(2.41 ±.25)																																		
	E/B	.110 Max.	(2.8)																																		
	E/B	.020 +.015-.010	(0.51+.38-.25)																																		
1812 S43	L	Inches	(mm)																																		
	W	.175 ±.010	(4.45 ±.25)																																		
	T	.125 ±.010	(3.17 ±.25)																																		
	E/B	.110 Max.	(2.8)																																		
	E/B	.035±.020	(0.89±.51)																																		
	* T	.140 Max.	(3.55)																																		

DIELECTRIC

X7R

X5R

Y5V

ELECTRICAL CHARACTERISTICS

	X7R	X5R	Y5V
Temperature Coefficient:	±15% (-55 to +125°C)	±15% (-55 to +85°C)	+22%, -82% (-30 to +85°C)
Dissipation Factor:	For ≥ 50 VDC: 5% max. For ≤ 25 VDC: 10% max.	For ≥ 50 VDC: 5% max. For ≤ 25 VDC: 10% max.	For ≥ 10 VDC: 16% max. For 6.3 VDC: 20% max.
Insulation Resistance (Min. @ 25°C, WVDC)	500 ΩF or 10 GΩ, whichever is less		
Dielectric Strength:	2.5 X WVDC, 25°C, 50mA max.		
Test Conditions:	Capacitance values ≤ 22 μF: 1.0kHz±50Hz @ 1.0±0.2 Vrms Capacitance values > 22 μF: 120Hz±10Hz @ 0.5V±0.1 Vrms		
Other:	See page 20 for additional dielectric specifications.		



X2Y® Filter & Decoupling Capacitors

The X2Y® Design - A Capacitive Circuit

X2Y® components share many common features with standard multi-layer ceramic capacitors (MLCC) for easy adoption by end-users.

- Same component sizes (0603, 0805, 1206, etc.)
- Same dielectric, electrode and termination materials
- Same pick and place equipment
- Same industry test standards for component reliability

A standard multi-layer ceramic capacitor (MLCC) consists of opposing electrode layers A & B. The X2Y® design adds another set of electrode layers (G) which effectively surround each existing electrode of a two-terminal capacitor. The only external difference is two additional side terminations, creating a four-terminal capacitive circuit, which allows circuit designers a multitude of attachment options.



X2Y® Circuit 1: Filtering

When used in circuit 1 configuration the X2Y® filter capacitor is connected across two signal lines. Differential mode noise is filtered to ground by the two Y capacitors, A & B. Common mode noise is cancelled within the device.

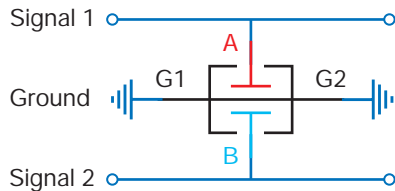

Experts agree that balance is the key to a “quiet” circuit. X2Y® is a balanced circuit device with two equal halves, tightly matched in both phase and magnitude with respect to ground. Several advantages are gained by two balanced capacitors sharing a single ceramic component body.

- Exceptional common mode rejection
- Effect of voltage variation eliminated
- Effects of aging & temperature are equal on both caps
- Matched line-to-ground capacitance

InAmp Input Filter Example

In this example, a single Johanson X2Y® component was used to filter noise at the input of a DC instrumentation amplifier. This reduced component count by 3-to-1 and costs by over 70% vs. conventional filter components that included 1% film Y-capacitors.

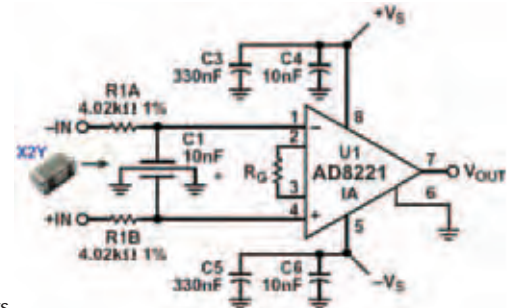

Parameter	X2Y® 10nF	Discrete 10nF, 2 @ 220 pF	Comments
DC offset shift	< 0.1 μ V	< 0.1 μ V	Referred to input
Common mode rejection	91 dB	92 dB	

Source: Analog Devices, “A Designer’s Guide to Instrumentation Amplifiers (2nd Edition)” by Charles Kitchin and Lew Counts

Common Mode Choke Replacement

In this example, a 5 μ H common mode choke is replaced by an 0805, 1000pF X2Y® component achieving superior EMI filtering by a component a fraction of the size and cost.

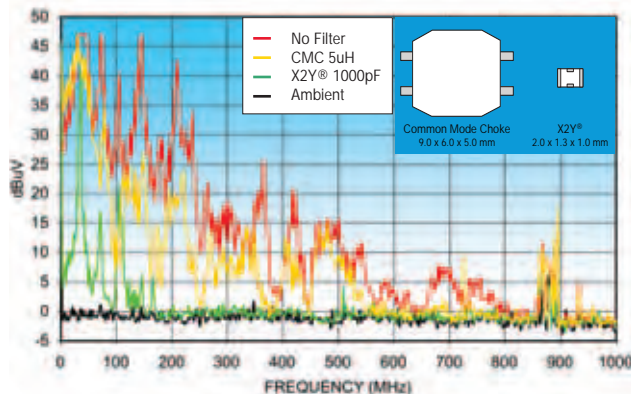

DC Motor EMI Reduction: A Superior Solution

One X2Y® component has successfully replaced 7 discrete filter components while achieving superior EMI filtering.

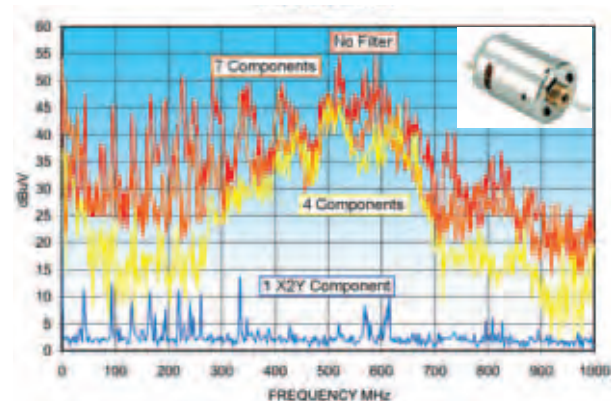

X2Y® Filter & Decoupling Capacitors

X2Y® Circuit 2: Decoupling

When used in circuit 2 configuration, A & B capacitors are placed in parallel effectively doubling the apparent capacitance while maintaining an ultra-low inductance. The low inductance advantages of the X2Y® Capacitor Circuit enables high-performance bypass networks at reduced system cost.

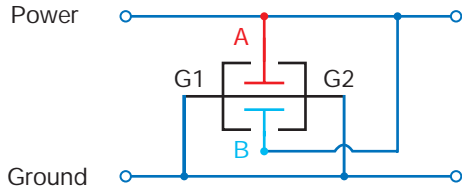

- Low ESL (device only and mounted)
- Broadband performance
- Effective on PCB or package

- Lower via count, improves routing
- Reduces component count
- Lowers placement cost

Component Performance

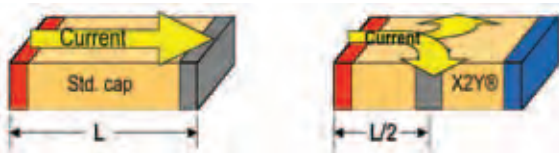

The X2Y® has short, multiple and opposing current paths resulting in lower device inductance.

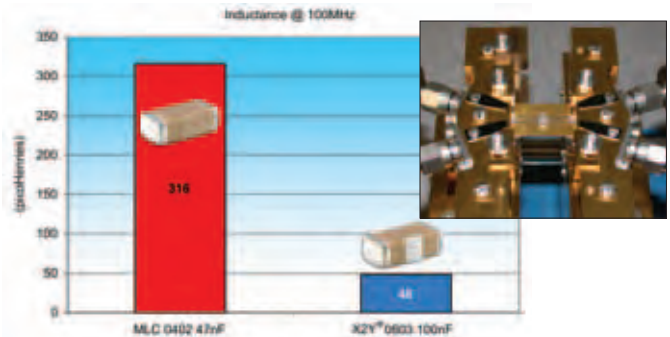

Mounted Performance

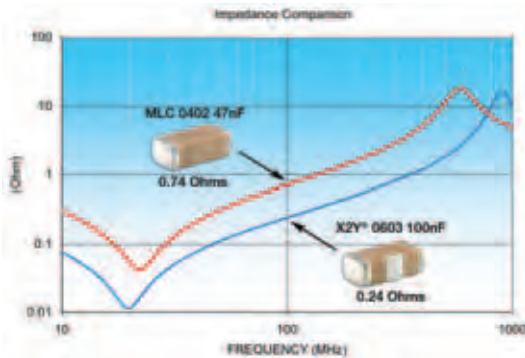

Mutual coupling from opposing polarity vias lowers inductance when mounted on a PCB.

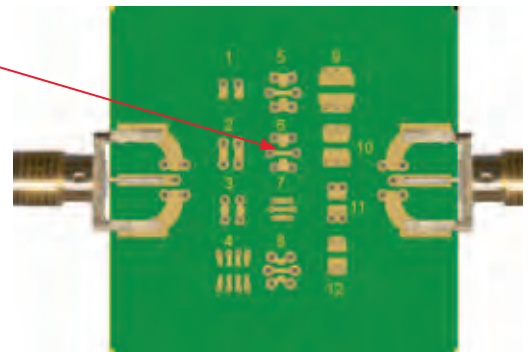

SYSTEM PERFORMANCE

1:5 MLCC Replacement Example

X2Y's® proven technology enables end-users to use one X2Y capacitor to replace five conventional MLCCs in a typical high performance IC bypass design. Vias are nearly cut in half, board space is reduced and savings are in dollars per PCB.

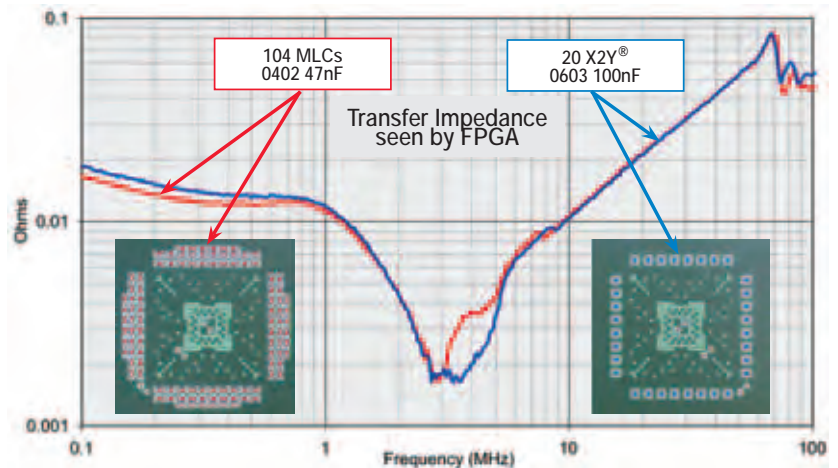

Sn-Pb X2Y® Filter & Decoupling Capacitors



X2Y® filter capacitors employ a unique, patented low inductance design featuring two balanced capacitors that are immune to temperature, voltage and aging performance differences.

These components offer superior decoupling and EMI filtering performance, virtually eliminate parasitics, and can replace multiple capacitors and inductors saving board space and reducing assembly costs.

ADVANTAGES

- One device for EMI suppression or decoupling
- Replace up to 7 components with one X2Y
- Differential and common mode attenuation
- Matched capacitance line to ground, both lines
- Low inductance due to cancellation effect

APPLICATIONS

- FPGA / ASIC / μ -P Decoupling
- DDR Memory Decoupling
- Amplifier Filter & Decoupling
- High Speed Data Filtering
- Cellular Handsets

Equivalent Circuits

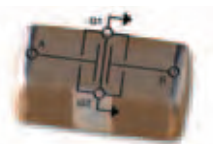
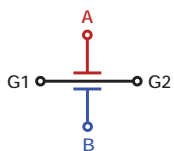

Cross-sectional View

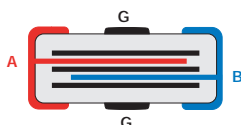

Dimensional View

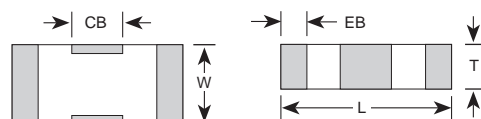

SIZE EIA (JDI)	Circuit 1 (Y Cap.)		1.0pF	5.6pF	10pF	22pF	27pF	33pF	47pF	100pF	220pF	470pF	1000pF	1500pF	2200pF	4700pF	.010mF	.022mF	.047mF	.10mF	.12mF	.22mF	.33mF	.40mF	.47mF		
	Circuit 2 (2*Y Cap.)		2.0pF	11.2pF	20pF	44pF	54pF	66pF	94pF	200pF	440pF	940pF	2000pF	3000pF	4400pF	9400pF	.020mF	.044mF	.094mF	0.20mF	0.24mF	0.44mF	0.68mF	0.80mF	0.94mF		
	Order Code		1R0	5R6	100	220	270	330	470	101	221	471	102	152	222	472	103	223	473	104	124	224	334	404	474		
0603 X14	NPO	50																									
		50																									
	X7R	25																									
		10																									
		6.3																									
0805 X15	NPO	100																									
		50																									
	X7R	100																									
50																											
1206 X18	NPO	50																									
	X7R	100																									
		50																									
1210 X41	X7R	100																									
		50																									
1410 X44	X7R	100																									
		50																									
1812 X43	X7R	100																									
		50																									

= NPO
 = X7R

Circuit 1 (Balanced Filtering) = A (or B) to G Circuit 2 (Decoupling) = A + B to G [A to B capacitance = 1/2 C1]
 Rated voltage is for A or B to ground. A to B rating is 2 X Vrated Contact the factory for other voltage ratings and capacitance values.

X2Y® technology patents and registered trademark under license from X2Y ATTENUATORS, LLC



Sn-Pb X2Y® Filter & Decoupling Capacitors

Filtering Circuit 1 S21 Signal-to-Ground

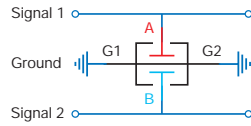

Decoupling Circuit 2 S21 Power-to-Ground

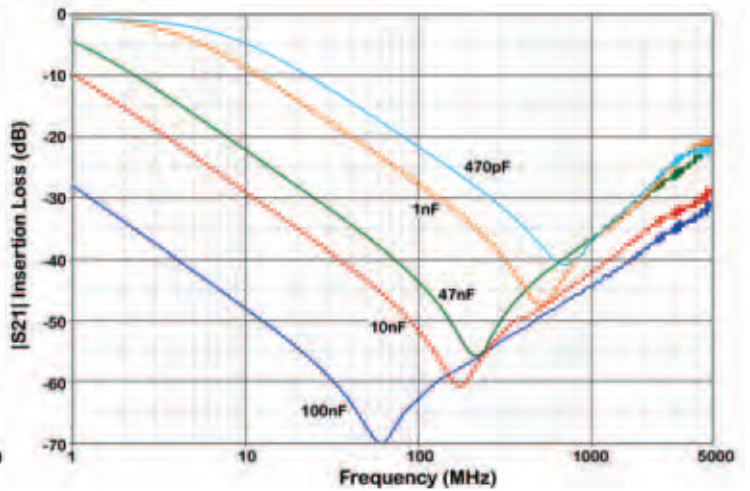
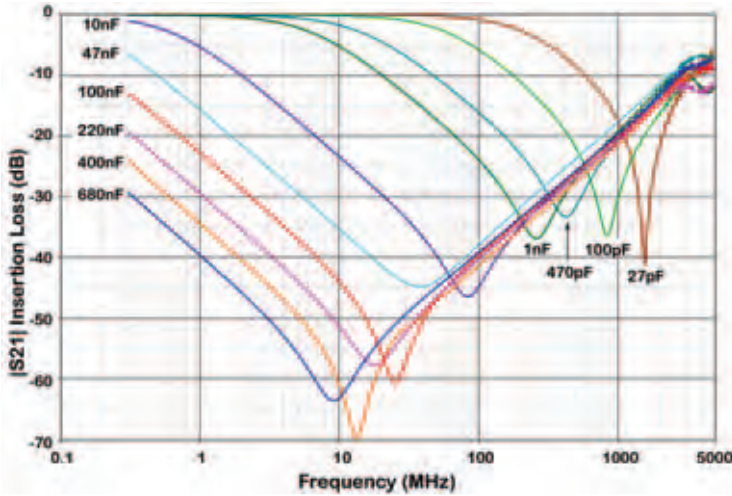
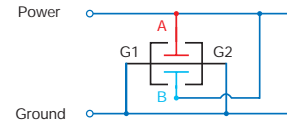

Additional test data and related information available at www.johansondielectrics.com/x2y/

MECHANICAL CHARACTERISTICS

	0402 (X07)		0603 (X14)		0805 (X15)		1206 (X18)		1210 (X41)		1410 (X44)		1812 (X43)	
	IN	mm	IN	mm	IN	mm	IN	mm	IN	mm	IN	mm	IN	mm
L	0.045 ± 0.003	1.143 ± 0.076	0.064 ± 0.005	1.626 ± 0.127	0.080 ± 0.008	2.032 ± 0.203	0.124 ± 0.010	3.150 ± 0.254	0.125 ± 0.010	3.175 ± 0.254	0.140 ± 0.010	3.556 ± 0.254	0.174 ± 0.010	4.420 ± 0.254
W	0.024 ± 0.003	0.610 ± 0.076	0.035 ± 0.005	0.889 ± 0.127	0.050 ± 0.008	1.270 ± 0.203	0.063 ± 0.010	1.600 ± 0.254	0.098 ± 0.010	2.489 ± 0.254	0.098 ± 0.010	2.490 ± 0.254	0.125 ± 0.010	3.175 ± 0.254
T	0.020 max	0.508 max	0.026 max	0.660 max	0.040 max	1.016 max	0.050 max	1.270 max	0.070 max	1.778 max	0.070 max	1.778 max	0.090 max	2.286 max
EB	0.008 ± 0.003	0.203 ± 0.076	0.009 ± 0.004	0.229 ± 0.102	0.009 ± 0.004	0.229 ± 0.102	0.009 ± 0.004	0.229 ± 0.102	0.009 ± 0.005	0.229 ± 0.127	0.009 ± 0.005	0.229 ± 0.127	0.009 ± 0.005	0.229 ± 0.127
CB	0.010 ± 0.003	0.305 ± 0.076	0.018 ± 0.004	0.457 ± 0.102	0.022 ± 0.005	0.559 ± 0.127	0.040 ± 0.005	1.016 ± 0.127	0.045 ± 0.005	1.143 ± 0.127	0.045 ± 0.005	1.143 ± 0.127	0.045 ± 0.005	1.143 ± 0.127

HOW TO ORDER X2Y® FILTER & DECOUPLING CAPACITORS

6R3	X14	W	104	M	T	4	T
VOLTAGE 6R3 = 6.3 V 100 = 25 V 250 = 25 V 500 = 50 V 101 = 100 V	CASE SIZE X07 = 0402 X14 = 0603 X15 = 0805 X18 = 1206 X41 = 1210 X43 = 1812 X44 = 1410	DIELECTRIC N = NPO W = X7R	CAPACITANCE 1st two digits are significant; third digit denotes number of zeros. 474 = 0.47 µF 105 = 1.00 µF	TOLERANCE M = ± 20%	TERMINATION T = Tin-Lead w/ 5% min. Pb	MARKING 4 = Unmarked	TAPE MODIFIER Code Tape Reel E Embossed 7" U Embossed 13" T Paper 7" R Paper 13" Tape specs. per EIA RS481

P/N written: 6R3X14W104MT4T

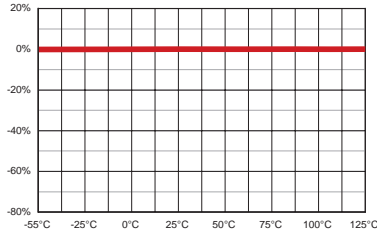
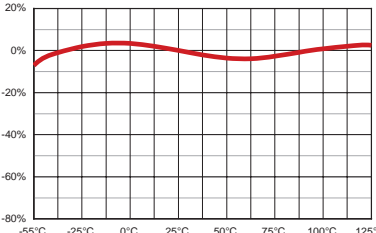

Electrical Characteristics

PARAMETER	NPO		X7R	
TEMPERATURE COEFFICIENT:	0 ± 30 ppm/°C	-55 to +125°C	± 15%	-55 to +125°C
				
DISSIPATION FACTOR:	.001 (0.1%) max		For Vrated ≥ 50 VDC, DF = 2.5% max For Vrated = 25 VDC, DF = 3.0% max For Vrated = 16 VDC, DF = 3.5% max	
AGING:	None		2.5% / decade hour	
INSULATION RESISTANCE:	IR @ 25°C, WVDC = 1000ΩF or 100GΩ whichever is less ¹ IR @ 125°C, WVDC = 10% of 25°C rating			
DIELECTRIC STRENGTH:	For Vrated = 6 - 200 VDC, DWV = 2.5 X WVDC, 25°C, 50mA max. For Vrated = 201 - 499 VDC, DWV = 2.0 X WVDC, 25°C, 50mA max. For Vrated = 500 - 999 VDC, DWV = 1.5 X WVDC, 25°C, 50mA max. For Vrated = 1000+ VDC, DWV = 1.2 X WVDC, 25°C, 50mA max.			
TEST PARAMETERS:	C > 100 pF; 1kHz ±50Hz; 1.0±0.2 VRMS C ≤ 100 pF 1Mhz ±50kHz; 1.0±0.2 VRMS		1kHz ±50Hz; 1.0±0.2 VRMS	
NOTES:	1) Tanceram Series: See Tanceram datasheet			

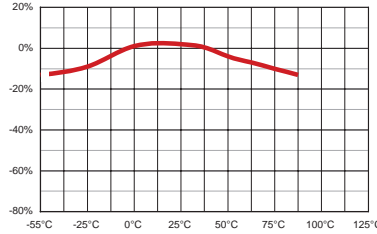
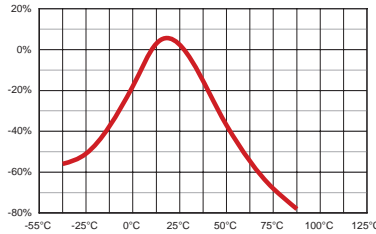
PARAMETER	X5R		Y5V	
TEMPERATURE COEFFICIENT:	± 15%	-55 to +85°C	+22% -82%	-30 to +85°C
				
DISSIPATION FACTOR:	For Vrated ≥ 25 VDC, DF = 3.0% max For Vrated = 16 VDC: DF = 3.5% max For Vrated = 10 VDC: DF = 5.0% max		For Vrated ≥ 25 VDC, DF = 5.0% max For Vrated = 16 VDC, DF = 7.0% max For Vrated = 10 VDC, DF = 9.0% max	
AGING:	2.5 % / decade hour		7.0% / decade hour	
INSULATION RESISTANCE:	IR @ 25°C, WVDC = 1000ΩF or 100GΩ whichever is less ²		IR @ 25°C, WVDC = 100ΩF or 10GΩ whichever is less	
DIELECTRIC STRENGTH:	DWV = 2.5 X WVDC, 25°C, 50mA max.		DWV = 2.5 X WVDC, 25°C, 50mA max.	
TEST PARAMETERS:	1kHz ±50Hz; 0.5±0.2 VRMS		1kHz ±50Hz; 1.0±0.2 VRMS	
NOTES:	2) Tanceram X5R IR = 500 ΩF or 10 GΩ			

High Reliability Testing Options

TEST	STANDARD
GROUP A TESTING	
100 Hour Burn In	MIL-PRF-55681
100% Electrical	MIL-PRF-55681
100% Visual	MIL-PRF-55681
Solderability	MIL-PRF-55681
Hot IR	MIL-PRF-55681
GROUP B TESTING	
Solderability	MIL-PRF-55681
TVC	MIL-PRF-55681
Class H Element Evaluation	MIL-PRF-38534
Class S Element Evaluation	MIL-PRF-38534
Class K Element Evaluation	MIL-PRF-38534

TEST	STANDARD
GROUP C TESTING	
Solderability	MIL-PRF-55681
TVC	MIL-PRF-55681
Thermal Shock 10 Cycles	MIL-PRF-55681
Resistance to Solder Heat	MIL-PRF-55681
Moisture Resistance	MIL-PRF-55681
Humidity	MIL-PRF-55681
2000 Hour Life Test	MIL-PRF-55681
Thermal Shock 100 Cycles	MIL-C-123
DPA	EIA 469
Shear Test / Bond Pull Test	As required
Wire Bond	As required
Similarity Data	As required

High reliability testing is available per published Military standards or customer specification. Please contact the factory for any required testing not listed.

Part Number Breakdown

500	R15	N	101	J	T	4	H
VOLTAGE	CASE SIZE	DIELECTRIC	CAPACITANCE	TOLERANCE	TERMINATION	MARKING	MODIFIER
100 = 10 V	R05=0201	N = NPO	1st two digits are significant; third digit denotes number of zeros, R = decimal.	* B = ± 0.10 pF	T = Tin-Lead with 5% min. Pb content	4 = Unmarked	Tape Code
160 = 16 V	R07=0402	W = X7R		* C = ± 0.25 pF		6 = EIA "J" Code*	Tape Type
250 = 25 V	A11=0405	X = X5R		* D = ± 0.50 pF		*Not available on sizes ≥ 0402	Reel Size
500 = 50 V	R14=0603	Y = Y5V		F = ± 1 %			U Embossed 13"
101 = 100 V	R15=0805		1R0 = 1.0 pF	G = ± 2%			R Punched 13"
201 = 200 V	X15=0805 X2Y		100 = 10 pF	J = ± 5%			E Embossed 7"
251 = 250 V	A18=0612		102 = 1,000 pF	K = ± 10%			T Punched 7"
301 = 300 V	R18=1206		474 = 0.47 µF	M = ± 20%			None = Bulk Packaging
501 = 500 V	X18=1206 X2Y			Z = +80 -20%			High Reliability Code
631 = 630 V	S41=1210			*Values < 10 pF only			H = High Rel tested per specified customer requirements.
102 = 1000 V	X41=1210 X2Y						
202 = 2000 V	X44=1410 X2Y						
302 = 3000 V	R29=1808						
402 = 4000 V	S43=1812						
502 = 5000 V	X43=1812 X2Y						
	S47=2220						
	S49=1825						
	S48=2225						

Part number written: 500R15N101JT4T

PLEASE NOTE: Not all combinations of JDI P/Ns are valid. Please refer to the appropriate "How to Order" section for a particular product or contact your Sales Representative if you need assistance.



Capacitor Packaging & Marking



Johanson capacitors are available taped per EIA standard 481. Tape options include 7" and 13" diameter reels. Johanson uses high quality, dust free, punched 8mm paper tape and plastic embossed 8mm tape for thicker MLCCs. Quantity per reel ranges are listed in the tables below and are dependent on chip thickness.

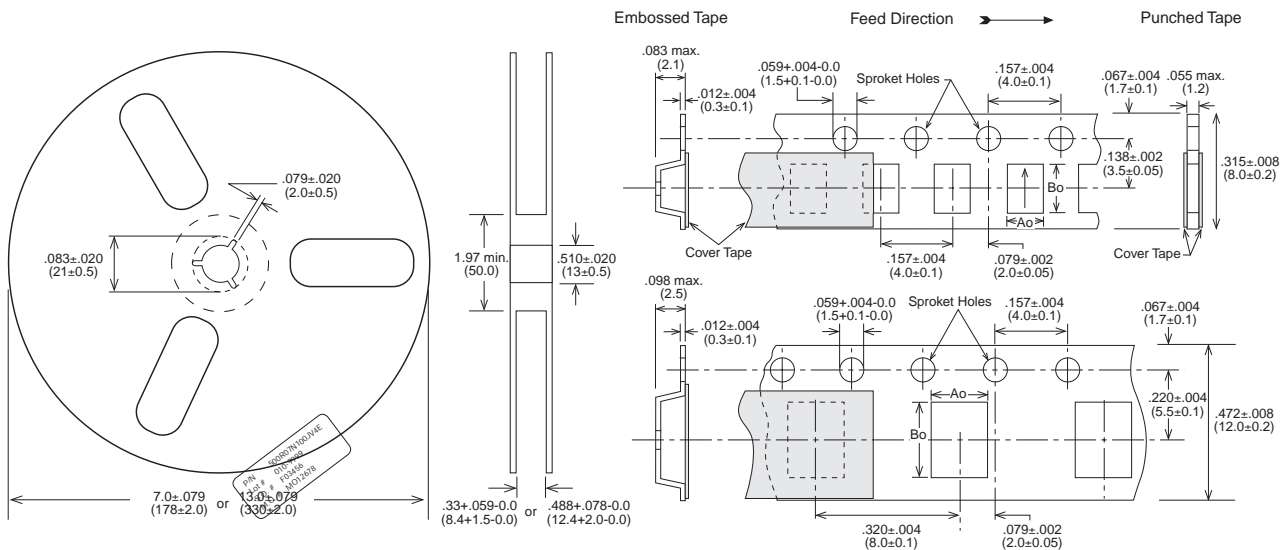

COMPONENT TYPE / SIZE	7" DIAMETER REEL				13" DIAMETER REEL			
	REEL QUANTITY	TAPE TYPE	TAPE SIZE	TAPE CODE	REEL QUANTITY	TAPE TYPE	TAPE SIZE	TAPE CODE
R05 / 0201 MLCC	15000	Paper	8mm	T	N/A	N/A		N/A
R07 / 0402 MLCC	10000	Paper	8mm	T	N/A	N/A		N/A
R14 / 0603 MLCC	4000	Paper	8mm	T	10000	Paper	8mm	R
R15 / 0805 MLCC	3000 - 4000	Paper / Embossed	8mm	T	10000	Paper / Embossed	8mm	U
R18 / 1206 MLCC	3000 - 4000	Paper / Embossed	8mm	T	10000	Paper / Embossed	8mm	U
S41 / 1210 MLCC	2000 - 4000	Embossed	8mm	E	10000	Embossed	8mm	U
R29 / 1808 MLCC	2000	Embossed	12mm	E	5000	Embossed	12mm	U
S43 / 1812 MLCC	1000	Embossed	12mm	E	5000	Embossed	12mm	U
S47 / 2220 MLCC	1000	Embossed	12mm	E	5000	Embossed	12mm	U
S49 / 1825 MLCC	1000	Embossed	12mm	E	5000	Embossed	12mm	U
S48 / 2225 MLCC	1000	Embossed	12mm	E	5000	Embossed	12mm	U

Online Resources: www.johansondielectrics.com

The screenshot displays the website for Johanson Dielectrics, Inc. The browser window title is "Surface Mount Ceramic Capacitors". The address bar shows "http://www.johansondielectrics.com/". The website header includes the company name "JOHANSON DIELECTRICS" and "SURFACE MOUNT CERAMIC CAPACITORS". A navigation menu lists: Contact / Sales Reps / Distributors / Partners / Company / Employment / Site Map / Site Search. The date is "Monday, October 4th, 2004".

Left Sidebar (Navigation):

- Surface Mount Products
- Leaded Products
- Technical Notes
- Prototyping Kits
- Cross Reference Charts
- X2Y® Technology
- Distributor Inventory

Searches:

SMT Caps:

Voltage Size Capacitance

JDI Part Number:

Enter at least first 7 chars.

Product Quick Links:

Product Search

Main Content Area:

Welcome to Johanson Dielectrics!

For everything from high volume, low cost capacitors to application specific ceramic solutions, Johanson Dielectrics has you covered.

Our wide product offering includes the following Capacitors: Ceramic SMT and Leaded High Voltage and High Temperature, Y2 Safety Certified, Tip & Ring, Tanceram (for Tantalum replacement), Dual and Multi Capacitor Arrays, Low Inductance, X2Y, Switchmode.

The combination of a high-quality and extensive product offering, low lead times, and a worldwide network of sales and manufacturing locations makes Johanson Dielectrics a world-class business partner.

Put our experience to work for you today!

Also, visit our partner companies for High Frequency and Ultra low ESR RF Capacitors, RF Inductors, Chip Antennas, Baluns, Diplexers, Couplers, Low Pass Filters and Band Pass Filters, Planar arrays and specialty products.

Environmental Compliance
Read our ROHS Compliance Statement, [click here.](#)

New Product!
X1/Y2 Safety Certified Capacitors
Size 1808, 250 VAC
10-680 pF, X7R & NPO Dielectrics
[Click here for more info](#)

Bottom Footer:

Product Information: [Surface Mount Products](#) / [Technical Notes](#) / [Prototyping Kits](#) / [Cross Reference Charts](#) / [X2Y Technology](#) / [Distributor Inventory](#)
Company Information: [Contact](#) / [Sales Reps](#) / [Distributors](#) / [Partners](#) / [Company](#) / [Employment](#) / [Site Map](#) / [Site Search](#)

Please contact our webmaster to report any problems you might experience. [Click here for recommended browsers and settings.](#)

All information on this page is subject to our [Legal Disclaimer](#). © Copyright 2004, All rights reserved.

Johanson Dielectrics, Inc. reserves the right to make design and price changes without notice. All sales are subject to the terms and conditions printed on the back side of our sales order acknowledgment forms, including a limited warranty and remedies for non-conforming goods or defective goods. We will be pleased to provide a copy of these terms and conditions for your review.



Your Technology Partner



15191 Bledsoe St., Sylmar, California 91342
TEL (818) 364-9800 • FAX (818) 364-6100
<http://www.johansondielectrics.com>

Mouser Electronics

Authorized Distributor

Click to View Pricing, Inventory, Delivery & Lifecycle Information:

Johanson:

[502R29W221KV3ESC](#) [502R29W102KV3ESC](#) [502R29N330JV3ESC](#) [502R29N330JV3E-****-SC](#)
[502R29W221KV3E-****-SC](#) [502R29W221MV3E-****-SC](#) [502R29N680JV3E-****-SC](#) [502R29N270KV3E-****-SC](#)
[502R29W151MV3E-****-SC](#) [502R29W151KV3U-****-SC](#) [502R29W181MV3E-****-SC](#) [502R29W221MV3U-****-SC](#)
[502R29N270JV3E-****-SC](#) [502R29N470JV3E-****-SC](#) [502R29N470KV3E-****-SC](#) [502R29W181KV3E-****-SC](#)
[502R29N560JV3E-****-SC](#) [502R29N330KV3E-****-SC](#) [502R29W221KV3U-****-SC](#) [502R29W151MV3U-****-SC](#)
[502R29N680KV3E-****-SC](#) [502R29W151KV3E-****-SC](#) [502R29N560KV3E-****-SC](#) [502R29W181MV3U-****-SC](#)
[502R29W181KV3U-****-SC](#) [500R05N260KV4T](#) [500R05N200KV4T](#) [500R05N200JV4T](#) [500R05N230JV4T](#)
[500R05N2R0DV4T](#) [500R05N220KV4T](#) [500R05N220JV4T](#) [500R05N1R8DV4T](#) [500R05N270KV4T](#)
[500R05N2R0BV4T](#) [500R05N250KV4T](#) [500R05N260JV4T](#) [500R05N230KV4T](#) [500R05N2R0CV4T](#)
[500R05N2R2DV4T](#) [500R05N240JV4T](#) [500R05N1R6DV4T](#) [500R05N240KV4T](#) [500R05N1R8BV4T](#) [500R05N250JV4T](#)
[500R05N270JV4T](#) [500R05N1R8CV4T](#) [500R05N2R2CV4T](#) [500R05N2R2BV4T](#)