



## Series 34B: Sealed Miniature Toggle Switches

### SERIES 34B Sealed Miniature Toggle Switches

#### FEATURES

- Save Space and Weight
- SPDT, DPDT, and 3PDT Circuitry
- Choice of Actuators, Bushings and Terminations
- Sealed per IP67

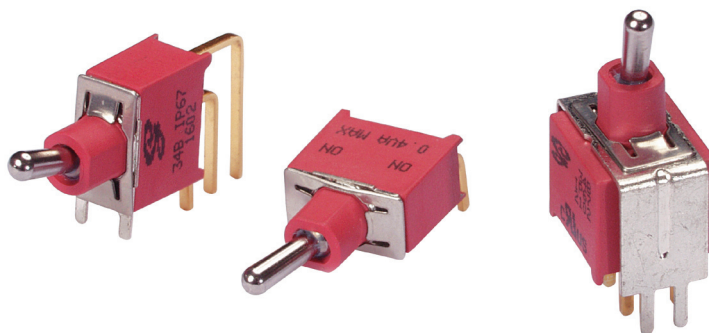

#### MODELS in inches (and millimeters)

##### SPDT

Model No.	Switching Position		
WSP1	ON	NONE	ON
WSP2	ON	NONE	(ON)
WSP3	ON	OFF	ON
WSP4	(ON)	OFF	(ON)
WSP5	ON	OFF	(ON)
Term. Comm.	2-3	OPEN	2-1

( )=MOMENTARY

SCHEMATIC

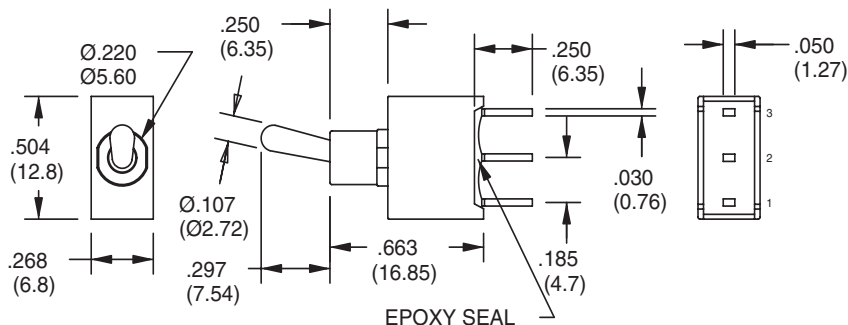

EPOXY SEAL

##### DPDT

Model No.	Switching Position		
WDP1	ON	NONE	ON
WDP2	ON	NONE	(ON)
WDP3	ON	OFF	ON
WDP4	(ON)	OFF	(ON)
WDP5	ON	OFF	(ON)
Term. Comm.	2-3 5-6	OPEN	2-1 5-4

( )=MOMENTARY

SCHEMATIC

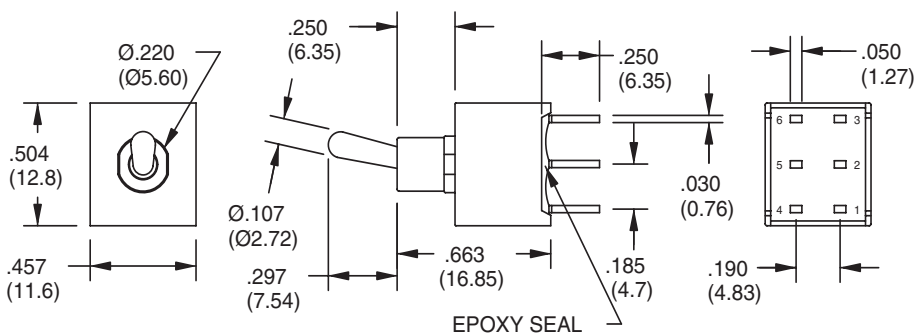
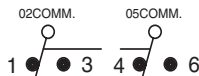

EPOXY SEAL

##### 3PDT

Model No.	Switching Position		
W3P1	ON	NONE	ON
W3P2	ON	NONE	(ON)
W3P3	ON	OFF	ON
W3P4	(ON)	OFF	(ON)
W3P5	ON	OFF	(ON)
Term. Comm.	2-3 5-6	OPEN	2-1 5-4

( )=MOMENTARY

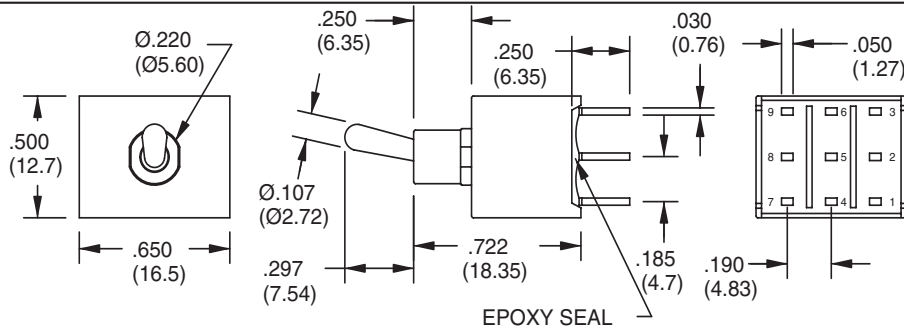
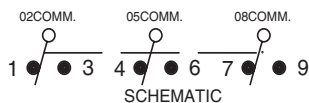

EPOXY SEAL

**ACTUATOR OPTIONS** in inches (and millimeters)

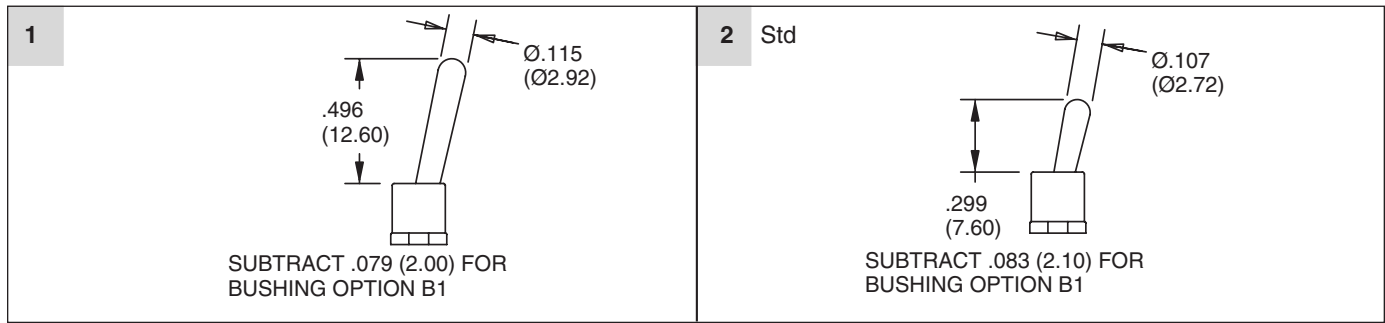

**BUSHING OPTIONS** in inches (and millimeters)

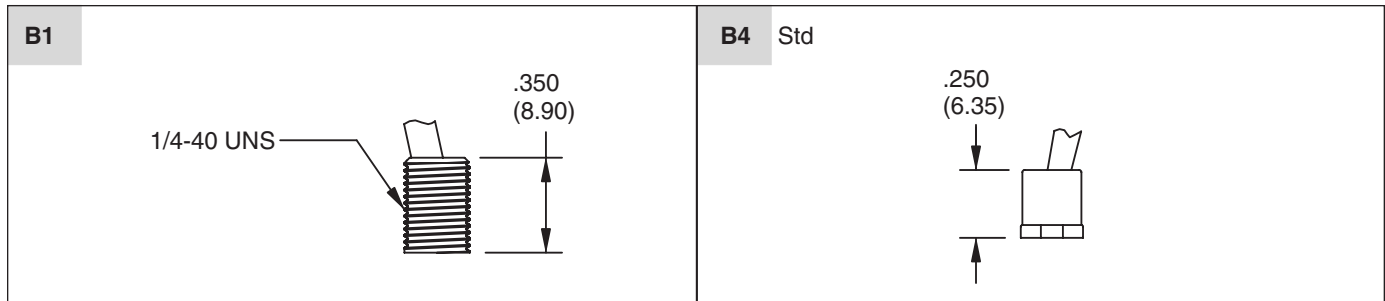

**TERMINATION OPTIONS** in inches (and millimeters)

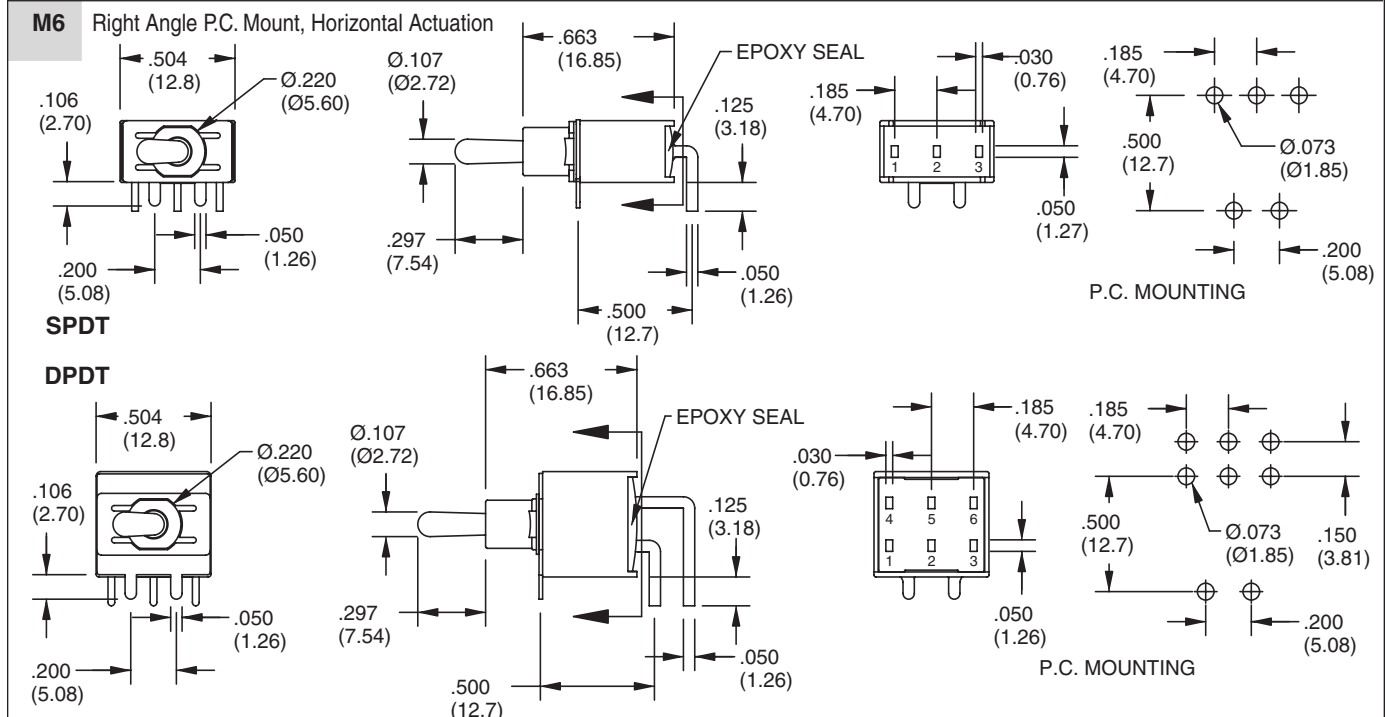
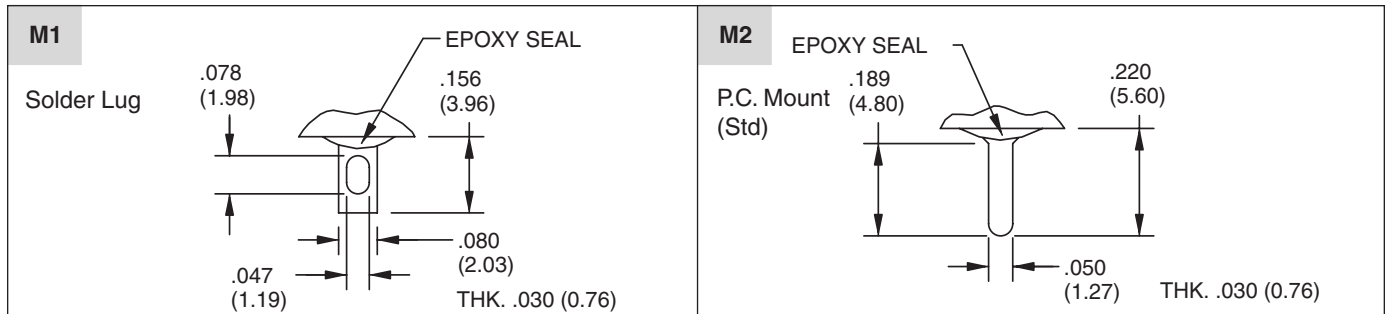

Toggle Switches



## Series 34B: Sealed Miniature Toggle Switches

### TERMINATION OPTIONS in inches (and millimeters)

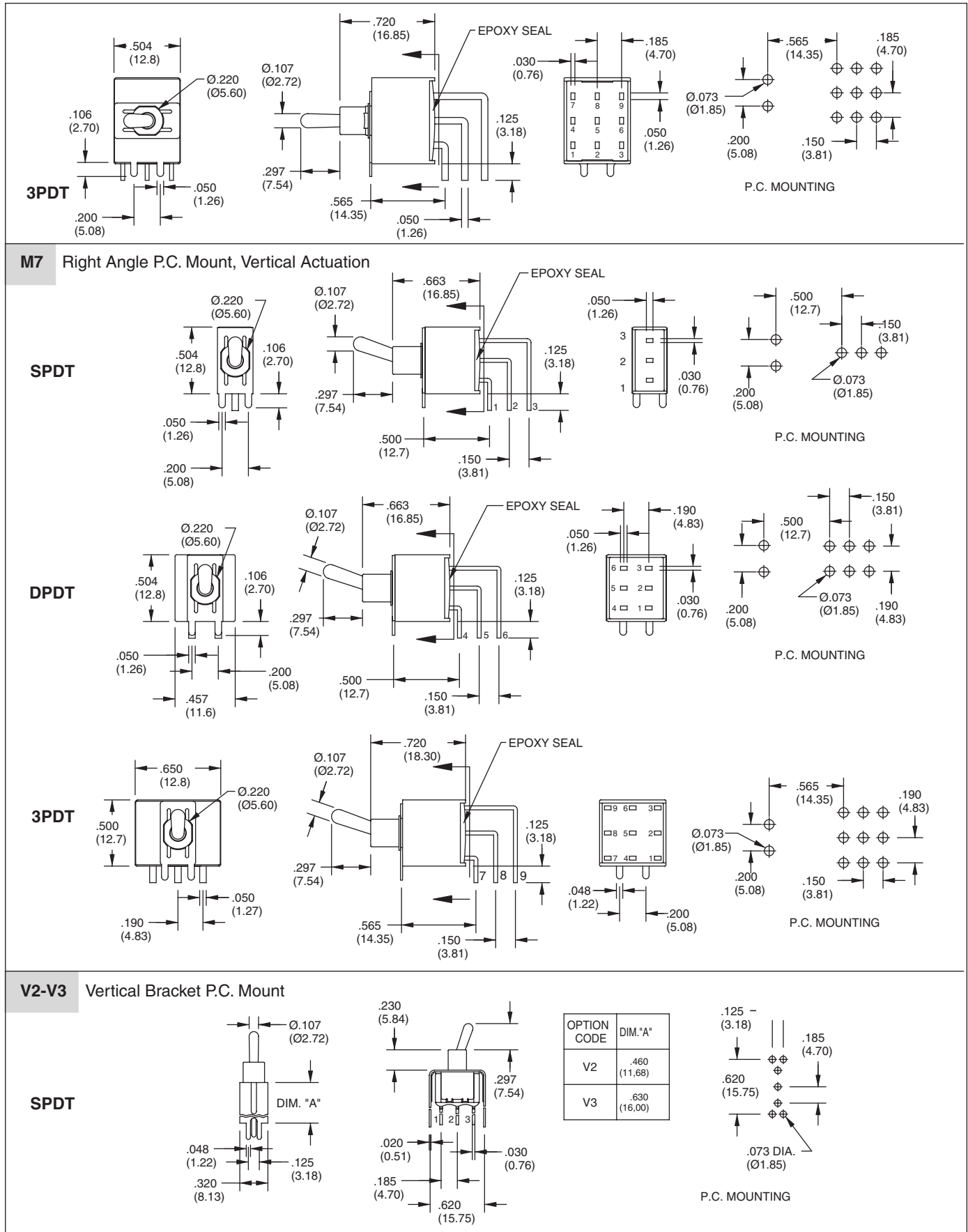

Toggle Switches

## Series 34B: Sealed Miniature Toggle Switches



### TERMINATION OPTIONS in inches (and millimeters)

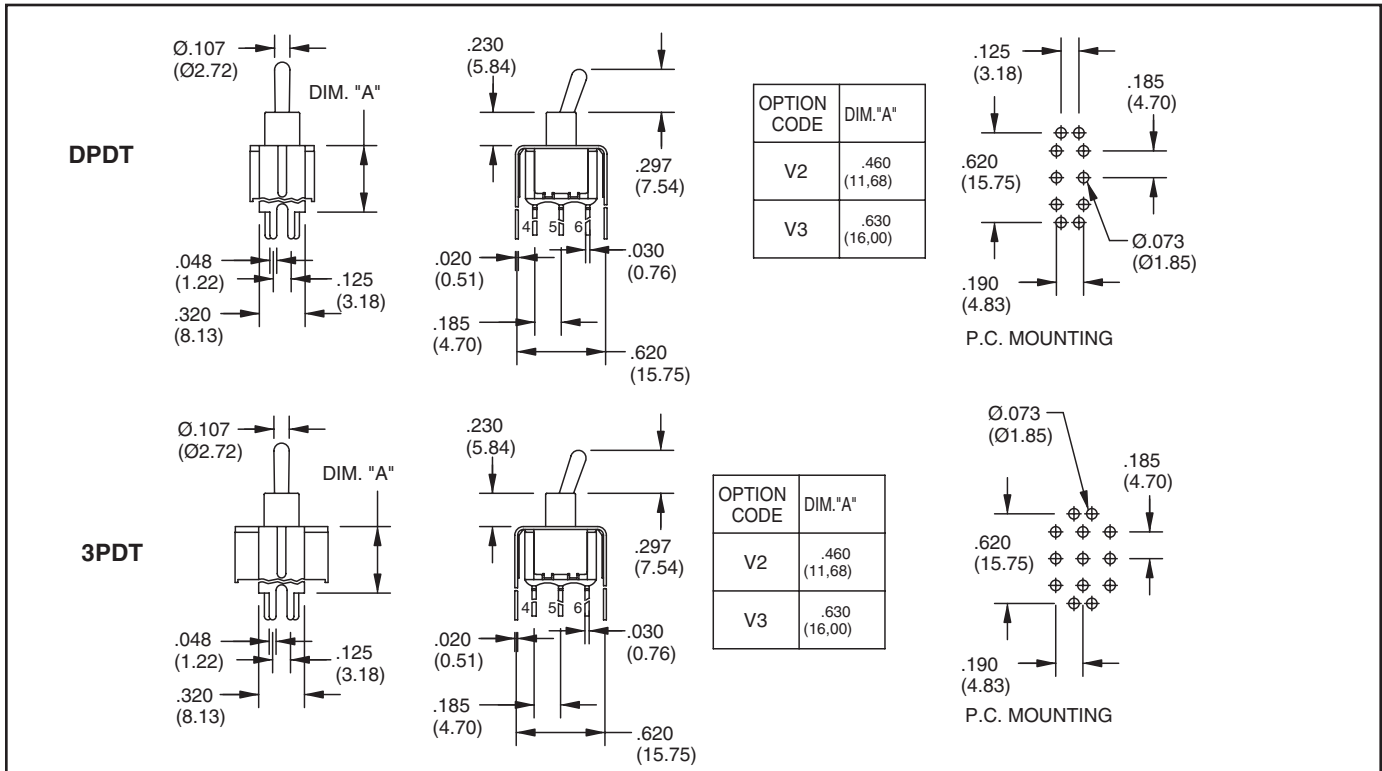

### SPECIFICATIONS

#### RATINGS

**Contact Rating:** Q option - 5A with resistive load @ 125VAC or 28 VDC; 2A with resistive load @ 250 VAC. R option-0.4 VA max @ 20 Vmax (AC or DC)

**Electrical Life:** 50,000 make-and-break cycles at full load

**Contact Resistance:** 10 milliohms max. initial @ 2-4 VDC, 100 mA

**Insulation Resistance:** 1,000 megaohms min  
**Dielectric Strength:** 1,500 V RMS @ sea level  
**Operating Temperature:** -30°C to 85°C

#### MATERIALS

**Case and Bushings:** Glass-filled nylon 6/6, flame retardant, heat stabilized (UL94V-0)  
**Frame:** Spring steel

**Actuator:** Brass, chrome plated. Internal O-ring seal standard with all actuators.

**Switch Support:** Brass, tin-plated

**Actuator Pivot & Mounting Bracket:** Nylon

**Actuator Pivot Retainer:** Stainless Steel

**Terminal and Contacts:** Copper alloy with plated over nickel or silver plate

**Terminal Seal:** Epoxy

### ORDERING INFORMATION

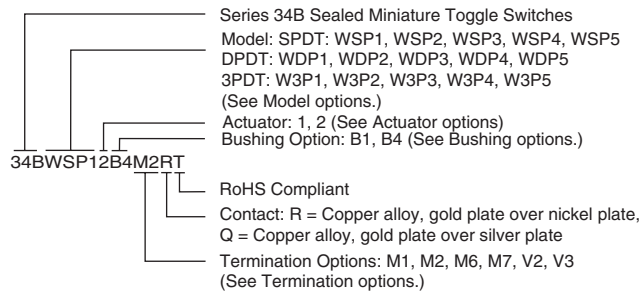

Available from your local Grayhill Component Distributor.

For prices and discounts, contact a local Sales Office, an authorized local Distributor or Grayhill.

### HARDWARE in inches (and millimeters)

