

REV. A	ECN NO.	DATE 2006/03/01	SIGN DAVID	DESCRIPTION Released Rev.A
B	LE3-710136	2006/12/13	Gao Ling	Move O-ring to ZSE00100774

THIS DOCUMENT IS SUBJECT TO CHANGE WITHOUT NOTICE. IT IS CONFIDENTIAL AND A PROPERTY OF Amphenol LTW. DISCLOSURE TO THIRD PARTY HAS TO BE AUTHORIZED BY Amphenol LTW.

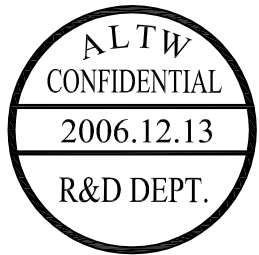

- Note:
- * @C Important Dimension.
 - * Waterproof Rate : IP68
IP68:1M of depth of water 24 hours
(防水等級 IP68)
(IP68:1米水深 24小時)
 - * Do Mating Test After Glued
點膠後, 須作對插測試
 - △* HD-SUB Conn. :Black Core , PBT
 - △* Plastic Jacket : Black , Nylon+GF
 - △* Pin : Copper Alloy , Gold Plated
 - △* Ring : Light Blue,Silicone
 - △* Screw : Copper Alloy,Nickel Plated,#4-40 UNC
 - * The 180° Board Lock Needs To Connect The Iron Shell
180° 型支架需接鐵殼

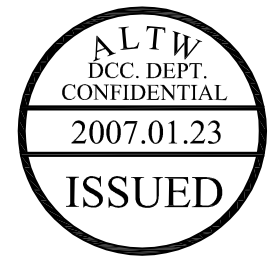
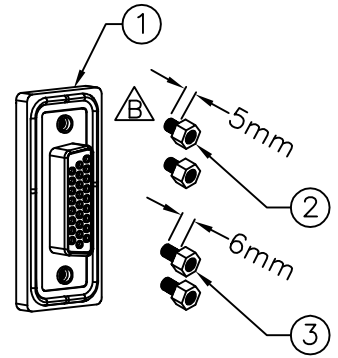
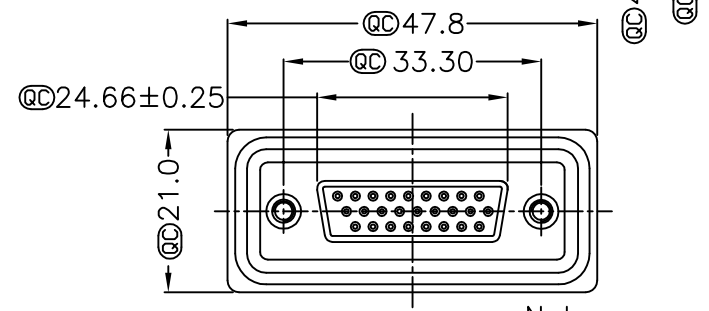
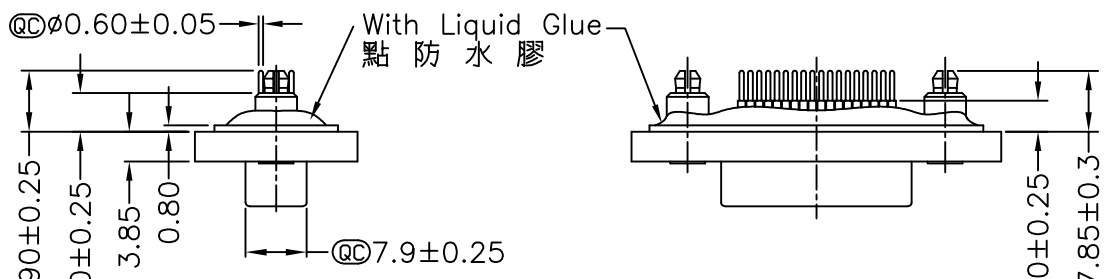
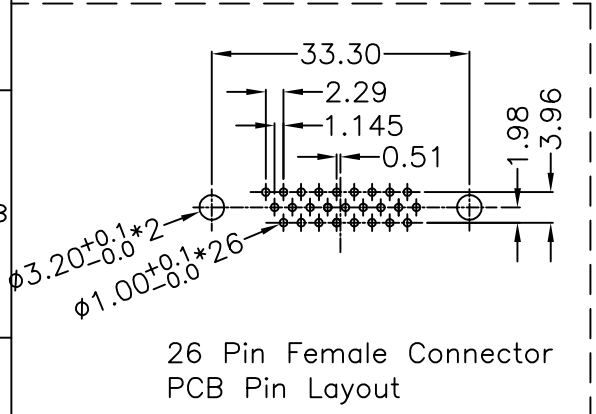

Screw L=5.0 For Panel Thickness Under 1.2mm
適用板厚為1.2mm以下

Screw L=6.0 For Panel Thickness Between 1.2~2.0mm
適用板厚為1.2~2.0mm

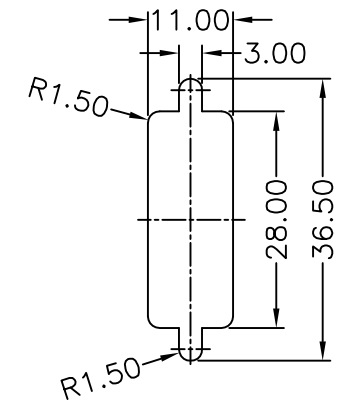

Recommended Panel Cut-Out
建議挖孔尺寸

UNIT:mm		TITLE HD-SUB Connector 26Pin Female For Panel,PCB 180° Board Lock
TOLERANCE .X ±0.25 .XX ±0.1 .XXX ±0.05 ANGLES ±1°	SCALE Free	SHEET 1 OF 1
REV. B	SIZE A4	@C :Inspection Item

Amphenol LTW
安費諾亮泰企業股份有限公司

ITEM NO HDB-26PFFP-SA8001	DRAWN BY Gao Ling	DATE 2006/12/13
DWG NO HDB-26PFFP-SA8001	CHECKED BY SIMON	DATE 2006/12/22
CUSTOMER ALTW	APPROVED BY MAX	DATE 2006/12/22

DRAWN BY Gao Ling	DATE 2006/12/13
CHECKED BY SIMON	DATE 2006/12/22
APPROVED BY MAX	DATE 2006/12/22

Mouser Electronics

Authorized Distributor

Click to View Pricing, Inventory, Delivery & Lifecycle Information:

[Amphenol:](#)

[HDB-26PFFP-SA8001](#)