

TOSHIBA CMOS LINEAR INTEGRATED CIRCUIT SILICON MONOLITHIC

TC75W55FU, TC75W55FK

DUAL OPERATIONAL AMPLIFIER

TC75W55 is a CMOS operational amplifier with low supply voltage, low supply current.

FEATURES

- Low supply voltage : $V_{DD} = \pm 0.9 \sim 3.5V$ or $1.8 \sim 7V$
- Low supply current : $I_{DD} (V_{DD} = 3V) = 20 \mu A$ (Typ.)
- The internally phase compensated operational amplifier.
- Small package

MAXIMUM RATINGS (Ta = 25°C)

CHARACTERISTIC	SYMBOL	RATING	N
Supply Voltage	V_{DD}, V_{SS}	7	V
Differential Input Voltage	DV_{IN}	± 7	V
Input Voltage	V_{IN}	$V_{DD} \sim V_{SS}$	V
Power Dissipation	P_D	250 (SM8)	mW
		200 (US8)	
Operating Temperature	T_{opr}	-40~85	°C
Storage Temperature	T_{stg}	-55~125	°C

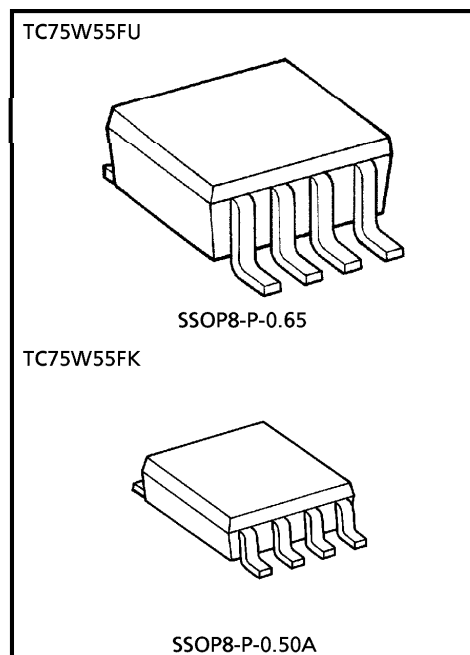

Weight
 SSOP8-P-0.65 : 0.021g (Typ.)
 SSOP8-P-0.50A : 0.01g (Typ.)

MARKING (TOP VIEW)

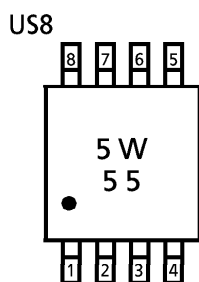
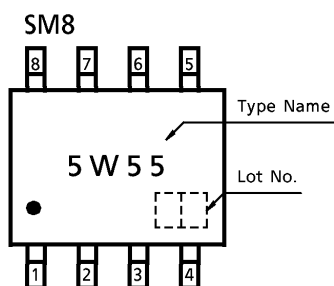

PIN CONNECTION (TOP VIEW)

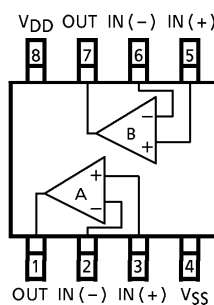

980508EBA1

- TOSHIBA is continually working to improve the quality and the reliability of its products. Nevertheless, semiconductor devices in general can malfunction or fail due to their inherent electrical sensitivity and vulnerability to physical stress. It is the responsibility of the buyer, when utilizing TOSHIBA products, to observe standards of safety, and to avoid situations in which a malfunction or failure of a TOSHIBA product could cause loss of human life, bodily injury or damage to property. In developing your designs, please ensure that TOSHIBA products are used within specified operating ranges as set forth in the most recent products specifications. Also, please keep in mind the precautions and conditions set forth in the TOSHIBA Semiconductor Reliability Handbook.
- The products described in this document are subject to foreign exchange and foreign trade laws.
- The information contained herein is presented only as a guide for the applications of our products. No responsibility is assumed by TOSHIBA CORPORATION for any infringements of intellectual property or other rights of the third parties which may result from its use. No license is granted by implication or otherwise under any intellectual property or other rights of TOSHIBA CORPORATION or others.
- The information contained herein is subject to change without notice.

ELECTRICAL CHARACTERISTICS

DC CHARACTERISTICS ($V_{DD} = 3.0V$, $V_{SS} = GND$, $T_a = 25^\circ C$)

CHARACTERISTIC	SYMBOL	TEST CIR-CUIT	TEST CONDITION	MIN.	TYP.	MAX.	UNIT
Input Offset Voltage	V_{IO}	1	$R_S = 10k\Omega$	—	2	10	mV
Input Offset Current	I_{IO}	—	—	—	1	—	pA
Input Bias Current	I_I	—	—	—	1	—	pA
Common Mode Input Voltage	CMV_{IN}	2	—	0.0	—	2.1	V
Voltage Gain (Open Loop)	G_V	—	—	60	70	—	dB
Maximum Output Voltage	V_{OH}	3	$R_L \geq 1M\Omega$	2.9	—	—	V
	V_{OL}	4	$R_L \geq 1M\Omega$	—	—	0.1	
Common Mode Input Signal Rejection Ratio	CMRR	2	$V_{IN} = 0.0 \sim 2.1V$	60	70	—	dB
Supply Voltage Rejection Ratio	SVRR	1	$V_{DD} = 1.8 \sim 7.0V$	60	70	—	dB
Supply Current	I_{DD}	5	—	—	20	40	μA
Source Current	I_{source}	6	—	10	20	—	μA
Sink Current	I_{sink}	7	—	100	450	—	μA

DC CHARACTERISTICS ($V_{DD} = 1.8V$, $V_{SS} = GND$, $T_a = 25^\circ C$)

CHARACTERISTIC	SYMBOL	TEST CIR-CUIT	TEST CONDITION	MIN.	TYP.	MAX.	UNIT
Input Offset Voltage	V_{IO}	1	$R_S = 100k\Omega$	—	2	10	mV
Input Offset Current	I_{IO}	—	—	—	1	—	pA
Input Bias Current	I_I	—	—	—	1	—	pA
Common Mode Input Voltage	CMV_{IN}	2	—	0.0	—	0.9	V
Voltage Gain (Open Loop)	G_V	—	—	60	70	—	dB
Maximum Output Voltage	V_{OH}	3	$R_L \geq 1M\Omega$	1.7	—	—	V
	V_{OL}	4	$R_L \geq 1M\Omega$	—	—	0.1	
Supply Current	I_{DD}	5	—	—	16	32	μA
Source Current	I_{source}	6	—	8	16	—	μA
Sink Current	I_{sink}	7	—	100	400	—	μA

AC CHARACTERISTICS ($V_{DD} = 3.0V$, $V_{SS} = GND$, $T_a = 25^\circ C$)

CHARACTERISTIC	SYMBOL	TEST CIR-CUIT	TEST CONDITION	MIN.	TYP.	MAX.	UNIT
Slew Rate	SR	—	—	—	0.08	—	V / μs
Unity Gain Cross Frequency	f_T	—	—	—	160	—	kHz

AC CHARACTERISTICS ($V_{DD} = 1.8V$, $V_{SS} = GND$, $T_a = 25^\circ C$)

CHARACTERISTIC	SYMBOL	TEST CIR-CUIT	TEST CONDITION	MIN.	TYP.	MAX.	UNIT
Slew Rate	SR	—	—	—	0.06	—	V / μs
Unity Gain Cross Frequency	f_T	—	—	—	140	—	kHz

TEST CIRCUIT

1. SVRR, V_{IO}

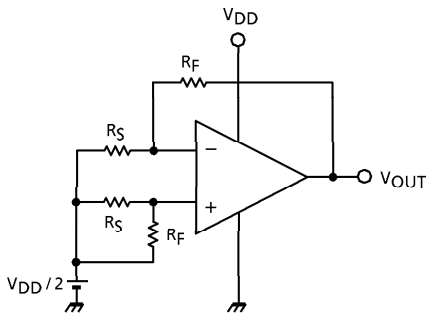

- SVRR
 $V_{DD} = 1.8V : V_{DD} = V_{DD1}, V_{OUT} = V_{OUT1}$
 $V_{DD} = 7.0V : V_{DD} = V_{DD2}, V_{OUT} = V_{OUT2}$

$$SVRR = 20 \log \left(\left| \frac{V_{OUT1} - V_{OUT2}}{V_{DD1} - V_{DD2}} \right| \times \frac{R_S}{R_F + R_S} \right)$$

- V_{IO}

$$V_{IO} = \left(V_{OUT} - \frac{V_{DD}}{2} \right) \times \frac{R_S}{R_F + R_S}$$

2. CMRR, CMV_{IN}

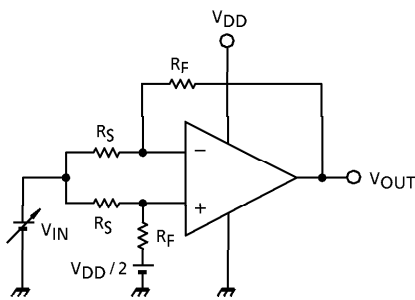

- CMRR
 $V_{IN} = 0.0V : V_{IN} = V_{IN1}, V_{OUT} = V_{OUT1}$
 $V_{IN} = 2.1V : V_{IN} = V_{IN2}, V_{OUT} = V_{OUT2}$

$$CMRR = 20 \log \left(\left| \frac{V_{OUT1} - V_{OUT2}}{V_{IN1} - V_{IN2}} \right| \times \frac{R_S}{R_F + R_S} \right)$$

- CMV_{IN}

3. V_{OH}

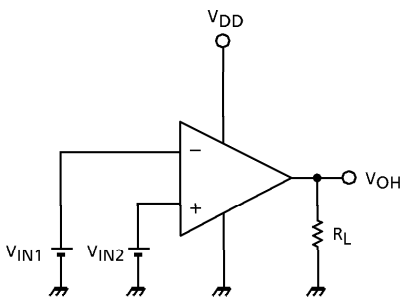

- V_{OH}

$$V_{IN1} = \frac{V_{DD}}{2} - 0.05V$$

$$V_{IN2} = \frac{V_{DD}}{2} + 0.05V$$

4. VOL

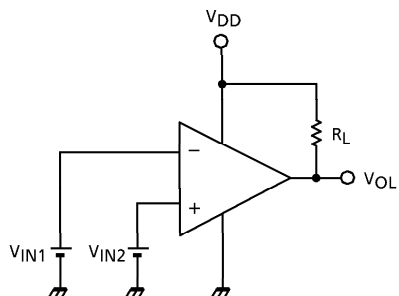

- VOL

$$V_{IN1} = \frac{V_{DD}}{2} + 0.05V$$

$$V_{IN2} = \frac{V_{DD}}{2} - 0.05V$$

5. IDD

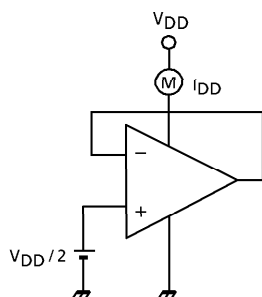

6. Isource

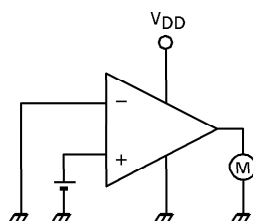

7. Isink

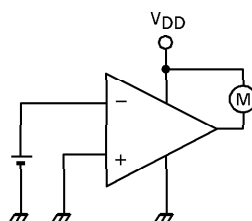

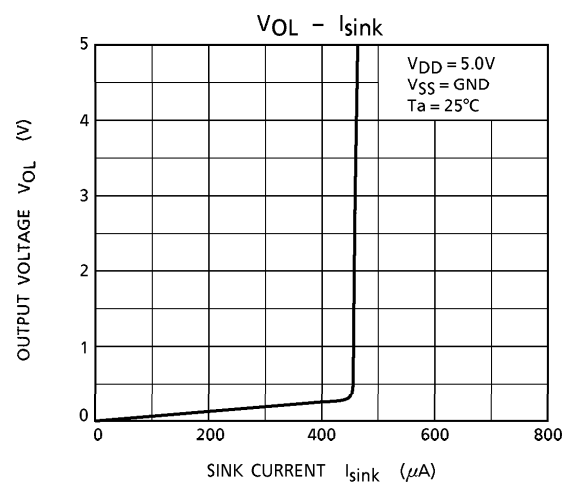
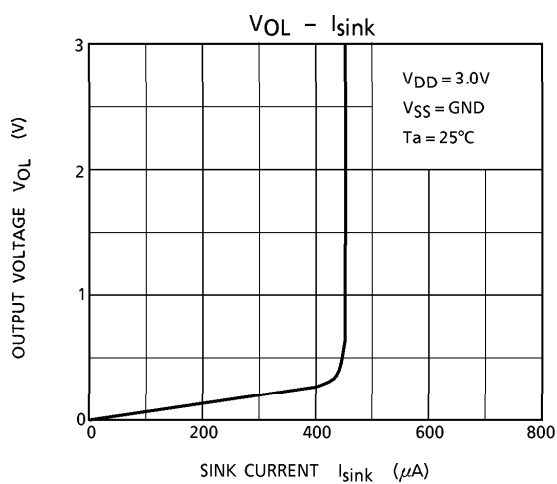
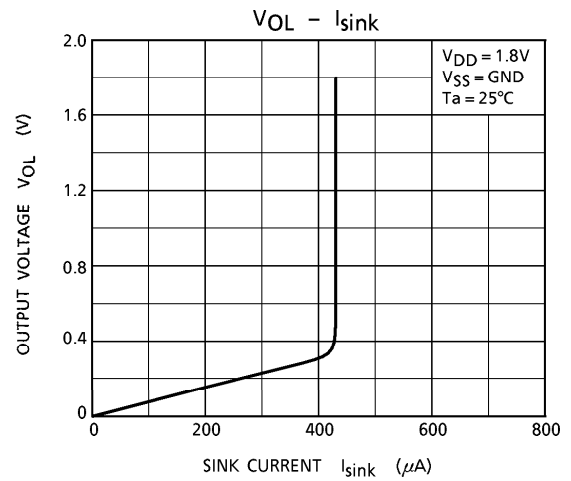
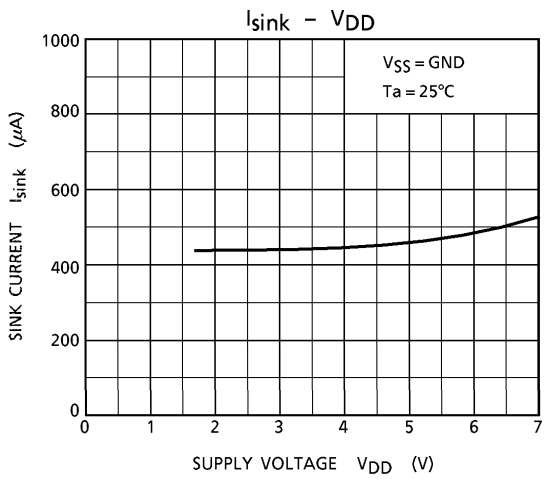
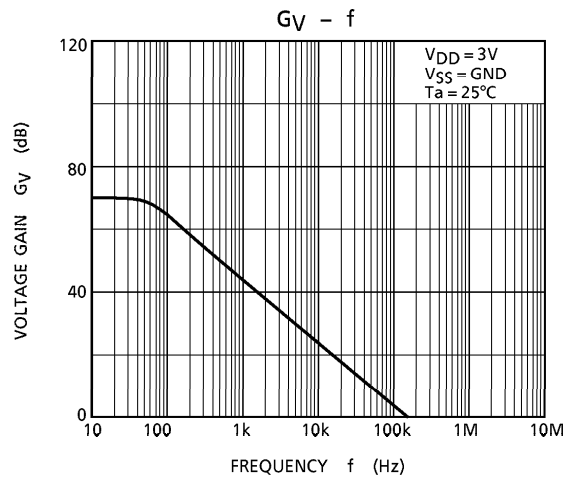
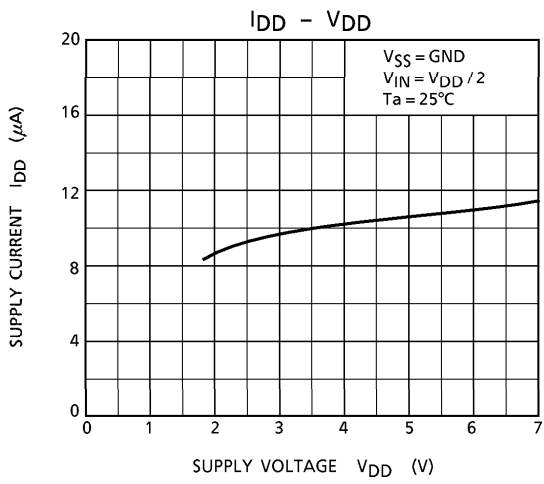

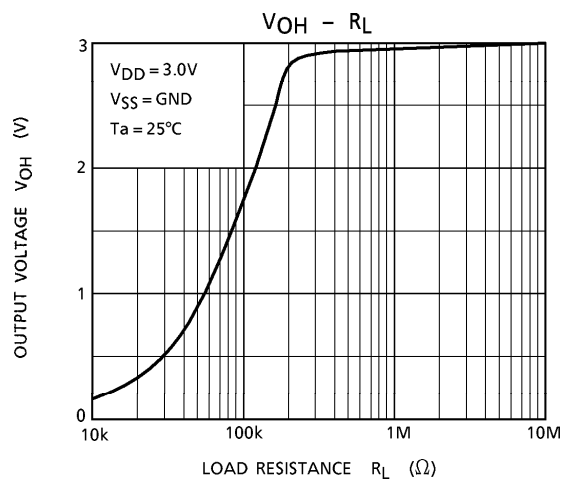
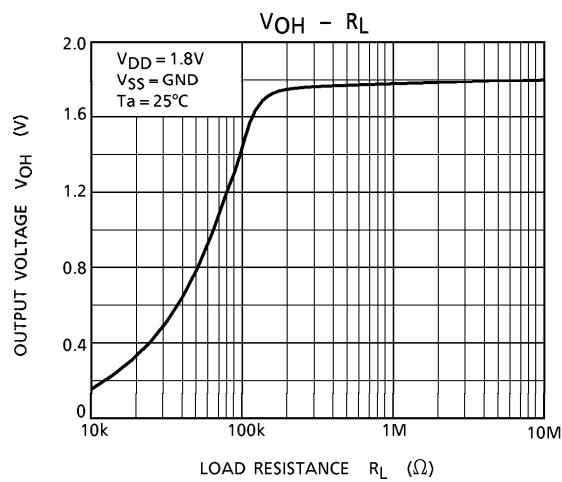
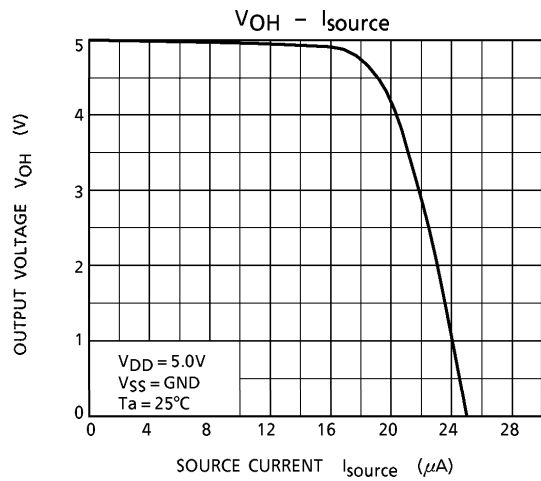
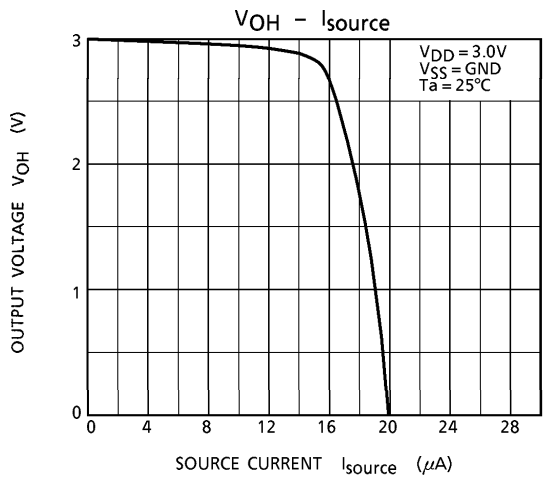
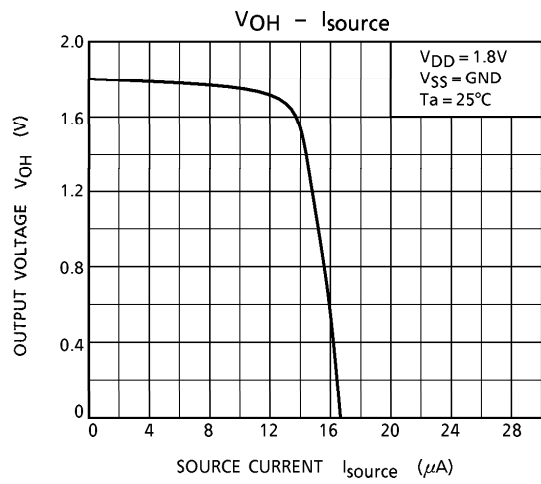
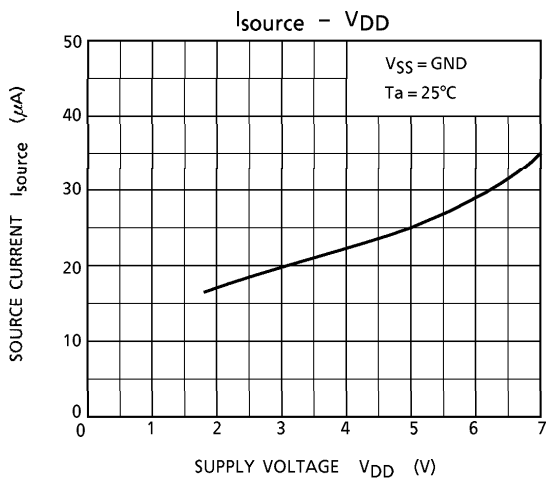

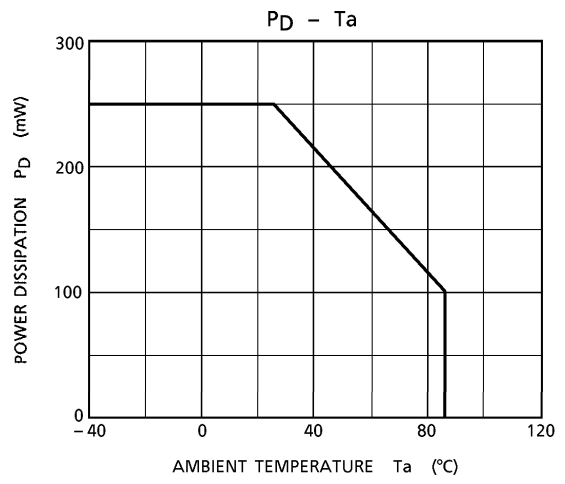
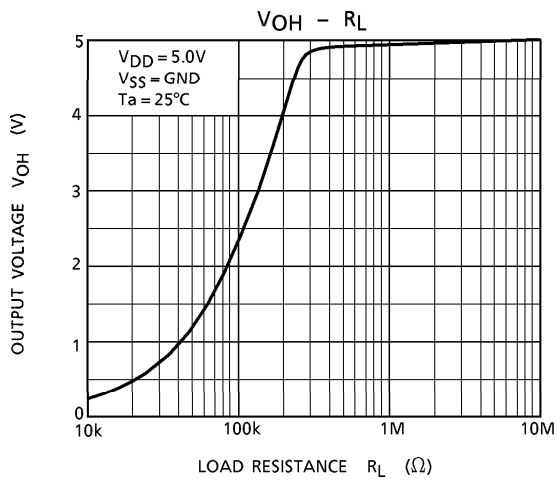

OUTLINE DRAWING
SSOP8-P-0.65

Unit : mm

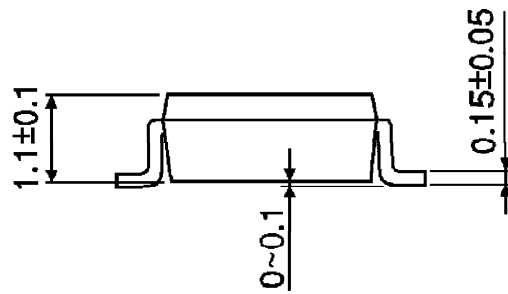
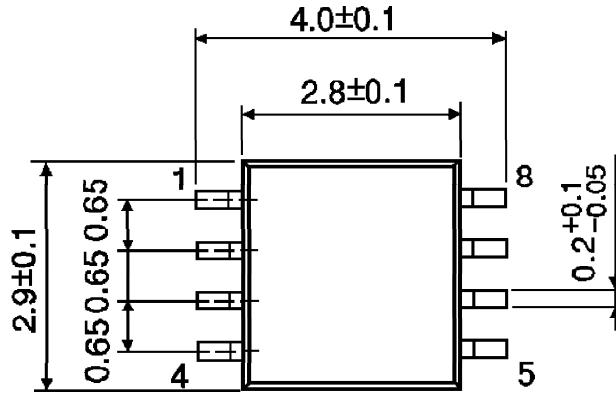

Weight : 0.021g (Typ.)

OUTLINE DRAWING
SSOP8-P-0.50A

Unit : mm

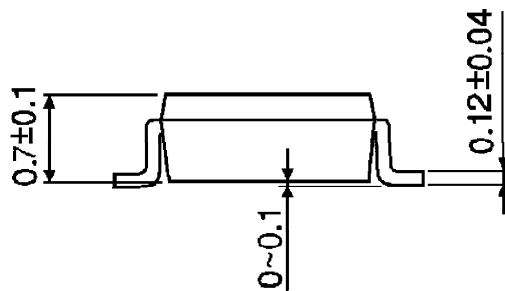
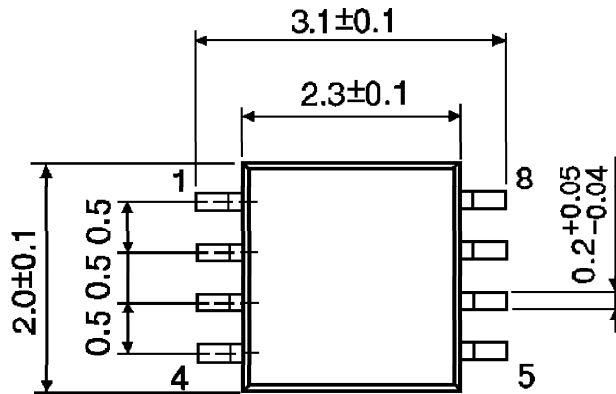

Weight : 0.01g (Typ.)

Mouser Electronics

Authorized Distributor

Click to View Pricing, Inventory, Delivery & Lifecycle Information:

[Toshiba:](#)

[TC75W55FU,LF](#)