

REVISIONS

P	LTR	DESCRIPTION	DATE	DWN	APVD
	B1	Released as per ECR-08-022292	4-Sep-08	SP	JC
	T	ECR-16-003733	12MAR2016	KR	TR

LASER MARKING: TE LOGO PN VALUE TOLERANCE & DATE CODE

2xØ3.3 HOLES

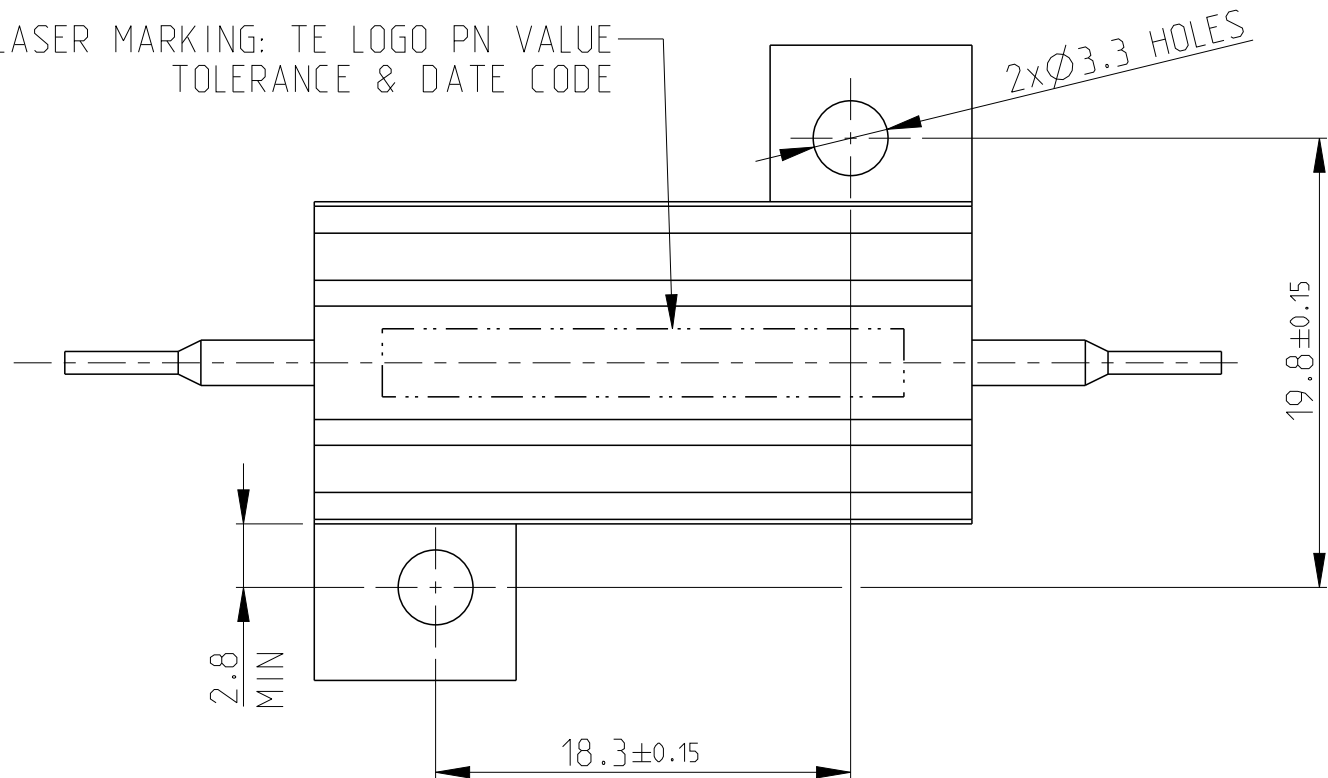

1 FOR FURTHER INFORMATION SEE DATA SHEET FOR HS SERIES-ALUMINIUM HOUSED RESISTORS

2 FOR A SPECIFIC PN FOR A RESISTANCE VALUE AND TOLERANCE, PLEASE REFER TO DMF

3 TECHNICAL SPECIFICATION

DISSIPATION AT 25°C : 25 WATTS MOUNTED ON STANDARD HEATSINK
 BS OHMIC RANGE : R051 TO 27K
 STABILITY : ΔR < =1% PER 1000Hrs
 ISOLATION VOLTAGE : 2500V DC/AC pk
 MAX WORKING VOLTAGE : 500V DC/AC rms
 TEMP COEFFICIENT : > 1R0 50ppm
 > 100R 25ppm
 CLIMATIC CATEGORY : 55/200/56

TAG HOLES Ø2/2.2

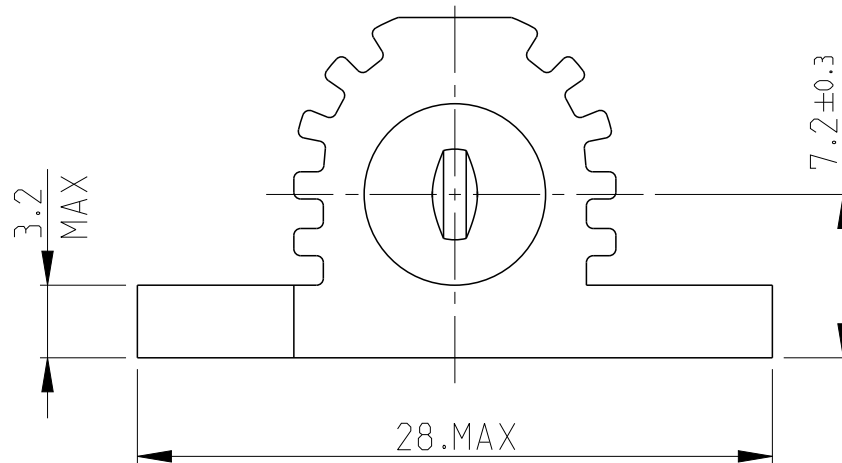
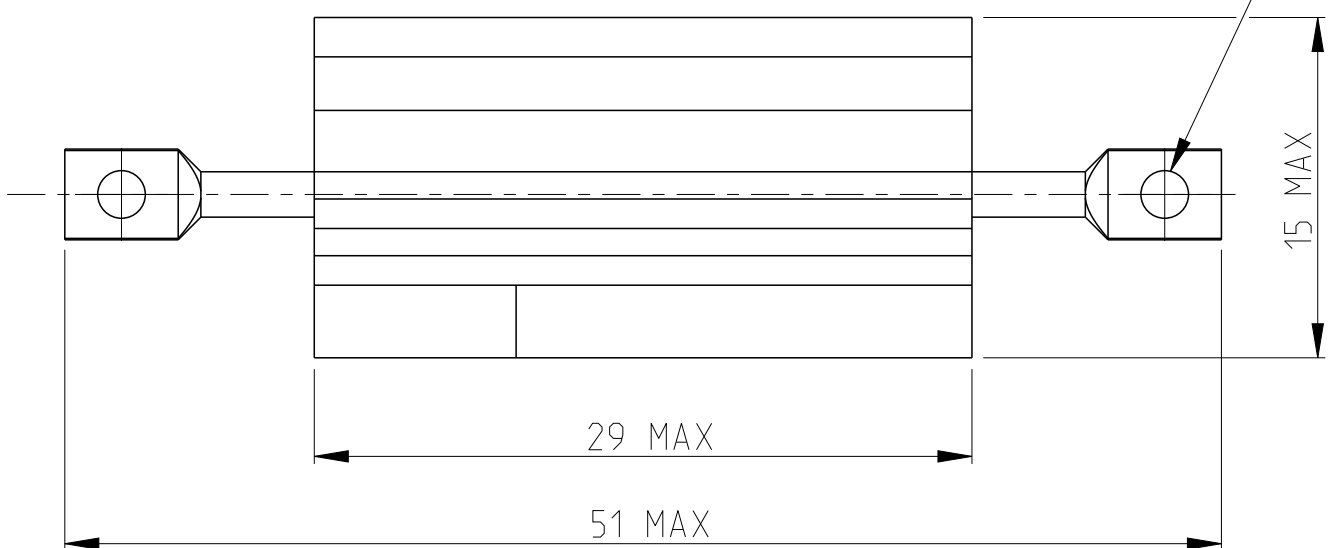

RoHS Compliant

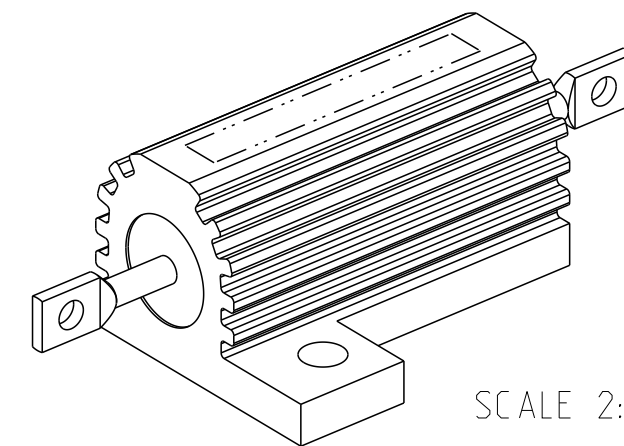

SCALE 2:1

THIS DRAWING IS A CONTROLLED DOCUMENT.

DWN 30,SEP.05 DAVE KENNEDY

CHK 03.OCT.05 J CATCHPOLE

APVD 03.OCT.05 J CATCHPOLE

PRODUCT SPEC

APPLICATION SPEC

WEIGHT

CUSTOMER DRAWING

NAME HSA25 METAL CLAD RESISTOR

SIZE CAGE CODE DRAWING NO RESTRICTED TO

A3 00779 C=1676625

SCALE 3:1 SHEET 1 OF 1 REV T

DIMENSIONS:

mm

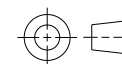

TOLERANCES UNLESS OTHERWISE SPECIFIED:

0 PLC	±0.5
1 PLC	±0.2
2 PLC	±0.1
3 PLC	±
4 PLC	±
ANGLES	±5°

MATERIAL

material_2

FINISH

finish_spec_2



TE Connectivity

Mouser Electronics

Authorized Distributor

Click to View Pricing, Inventory, Delivery & Lifecycle Information:

[TE Connectivity:](#)

[HSA2548RJ](#)