

MULTI-CON-X[®]
SEALED CONNECTORS
AND CABLES

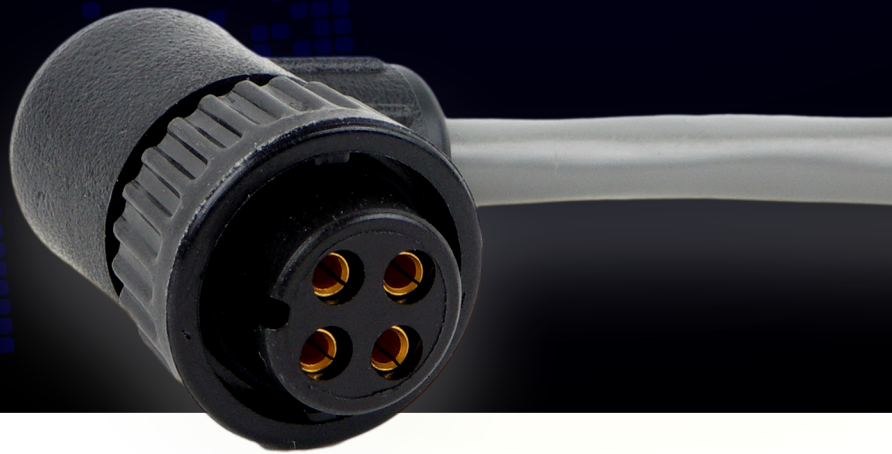

Switchcraft[®]
CONXALL[®]

HARSH ENVIRONMENT CONNECTIVITY SOLUTIONS

Multi-Con-X® Sealed Connectors

Thousands of configurations are available up to 12 contacts with a variety of options

Coupling rings have overriding locking features to prevent loosening or separation of connector



Available as field installable connectors or factory molded cable assemblies

Compact size fits in a 0.43" [10.9mm] mounting hole

CONXALL®
PRODUCT

The Multi Con X® series from Conxall® sets the standard for harsh environment connectors. It is built to withstand harsh environments with an IP67 seal rating, and a 600V voltage rating makes it an ideal solution for power or signal. Thousands of configurations are available up to 12 contacts, including mixed contact sizes and custom factory molded cable assemblies.

IP67

**RATED WATER
RESISTANCE**

The Con-X® series is sealed to IP67 for harsh environments when used with a molded cable assembly.



**600V VOLTAGE
RATING**

600V voltage rating makes it an ideal solution for power or signal.



**CONXALL
QUALITY**

Made in USA to the high standards that have made Conxall the leading name in harsh environment connectors.

VISIT WWW.SWITCHCRAFT.COM FOR THE MOST UP-TO-DATE PRODUCT SPECIFICATIONS

MULTI-CON-X® LINE



CABLE END - SOCKET
MATES WITH PANEL MOUNT AND
CABLE TO CABLE



CABLE END - PIN
MATES WITH PANEL MOUNT AND
CABLE TO CABLE



CABLE TO CABLE / INLINE - SOCKET
MATES WITH CABLE END



PANEL MOUNT - PIN
MATES WITH CABLE END



PANEL MOUNT - SOCKET
MATES WITH CABLE END



DUST CAP
P/N - 4295



MOLDED CABLE END ASSEMBLY



MOLDED CABLE TO CABLE ASSEMBLY



MOLDED RIGHT ANGLE CABLE ASSEMBLY

MIXED SIGNAL/POWER



CABLE END - SOCKET
MATES WITH PANEL MOUNT AND
CABLE TO CABLE



CABLE END - PIN
MATES WITH PANEL MOUNT AND
CABLE TO CABLE



CABLE TO CABLE / INLINE - SOCKET
MATES WITH CABLE END

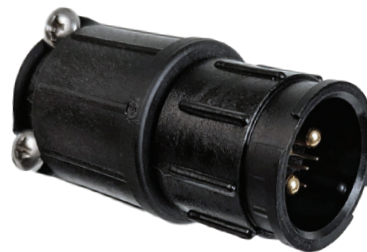

CABLE TO CABLE / INLINE - PIN
MATES WITH CABLE END



PANEL MOUNT - PIN
MATES WITH CABLE END



PANEL MOUNT SOCKET
MATES WITH CABLE END

Multi-Con-X® Sealed Connectors

FIELD INSTALLABLE KITS

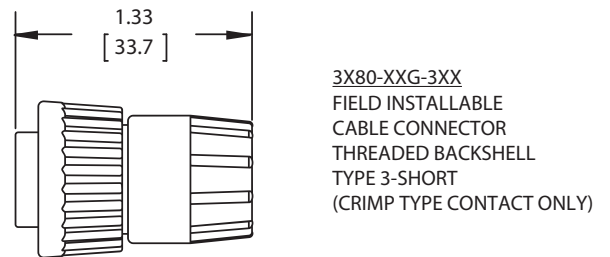
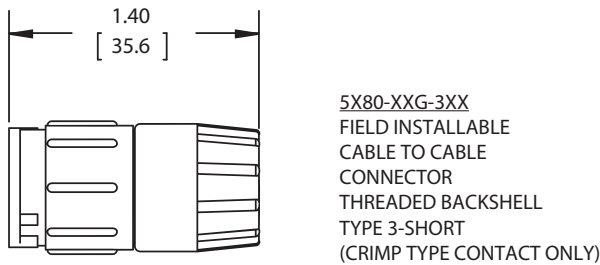
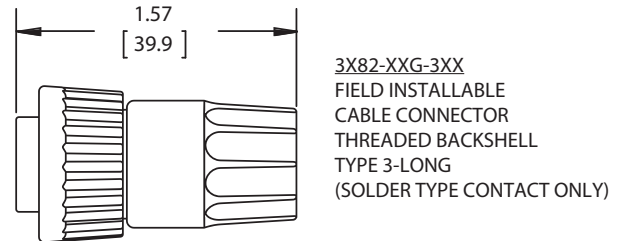
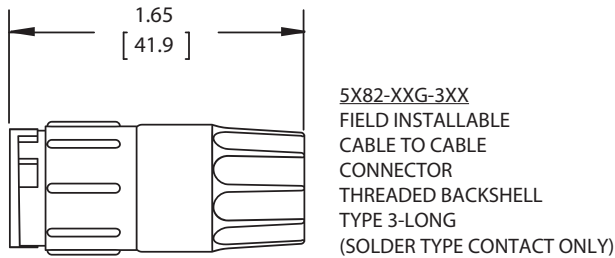
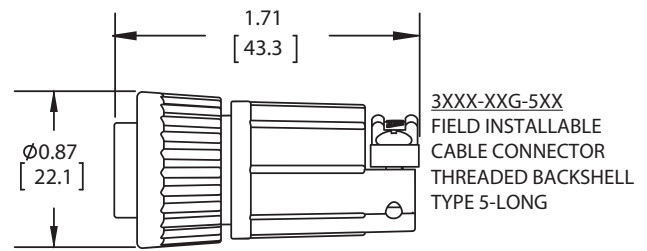
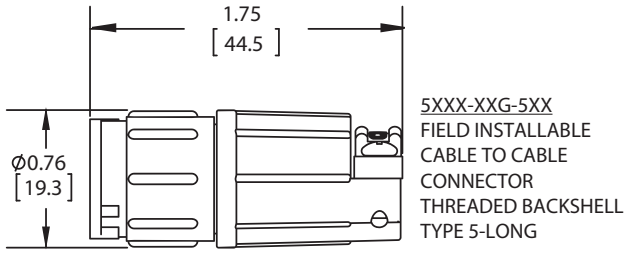

PANEL MOUNT ASSEMBLY KITS

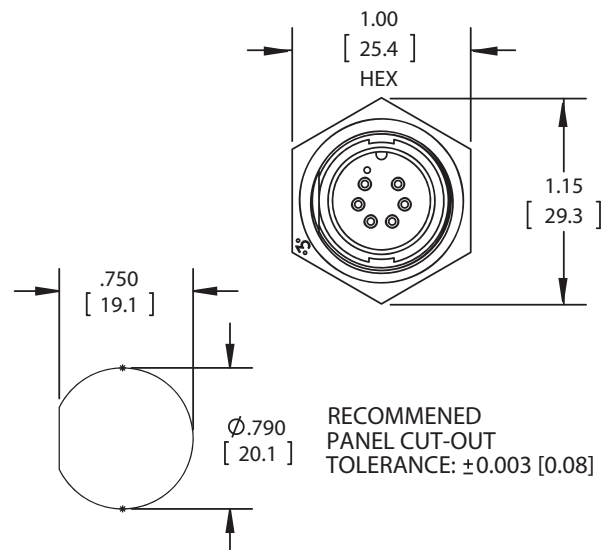
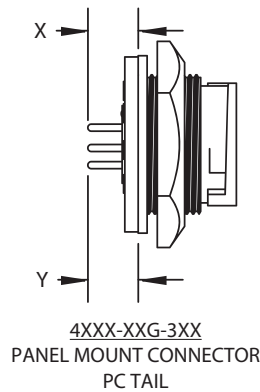
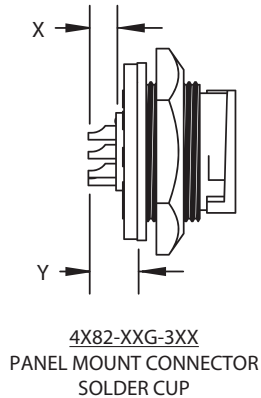
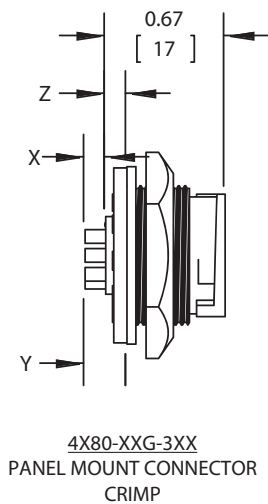

*X, Y, Z - Consult Factory. All dimensions are for reference only. Units shown: in[mm].

Multi-Con-X® Sealed Connectors

PANEL MOUNT / CABLE TO CABLE CONNECTORS

Front View | Wire View

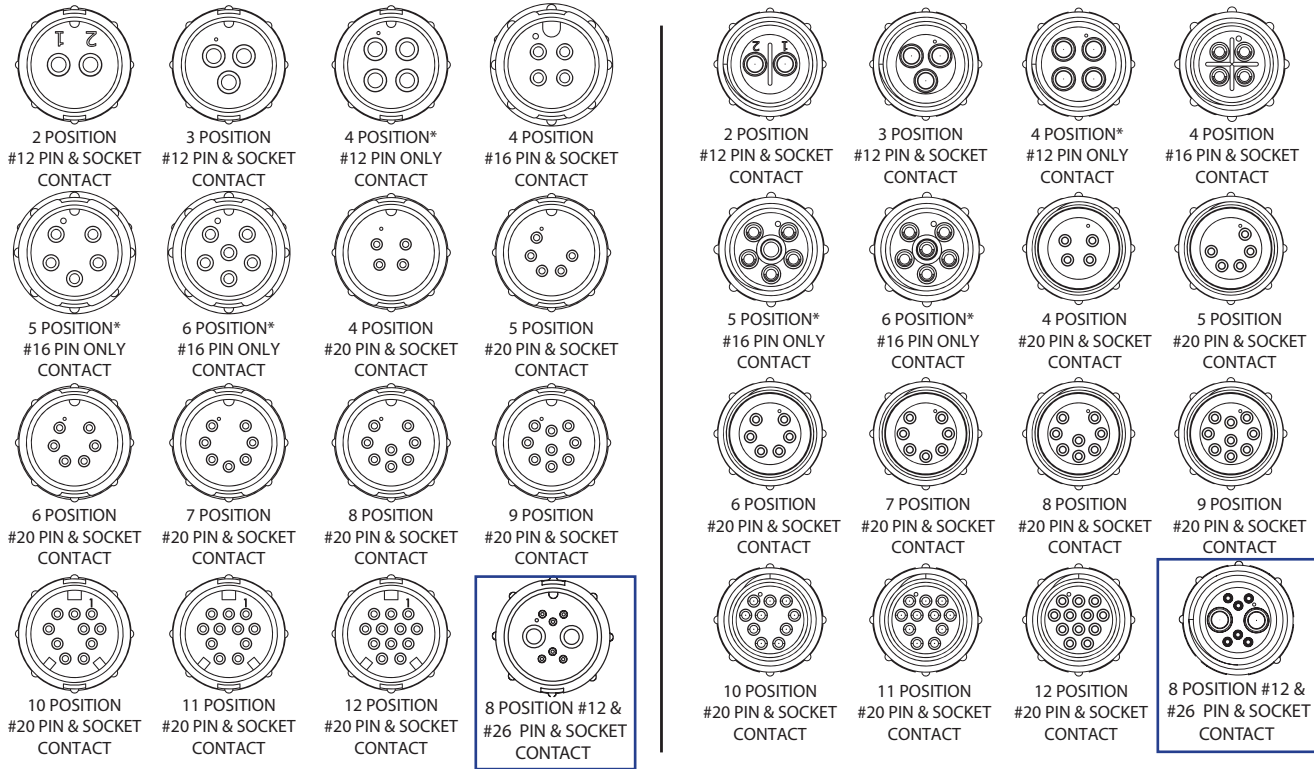

CABLE CONNECTORS

Front View | Wire View

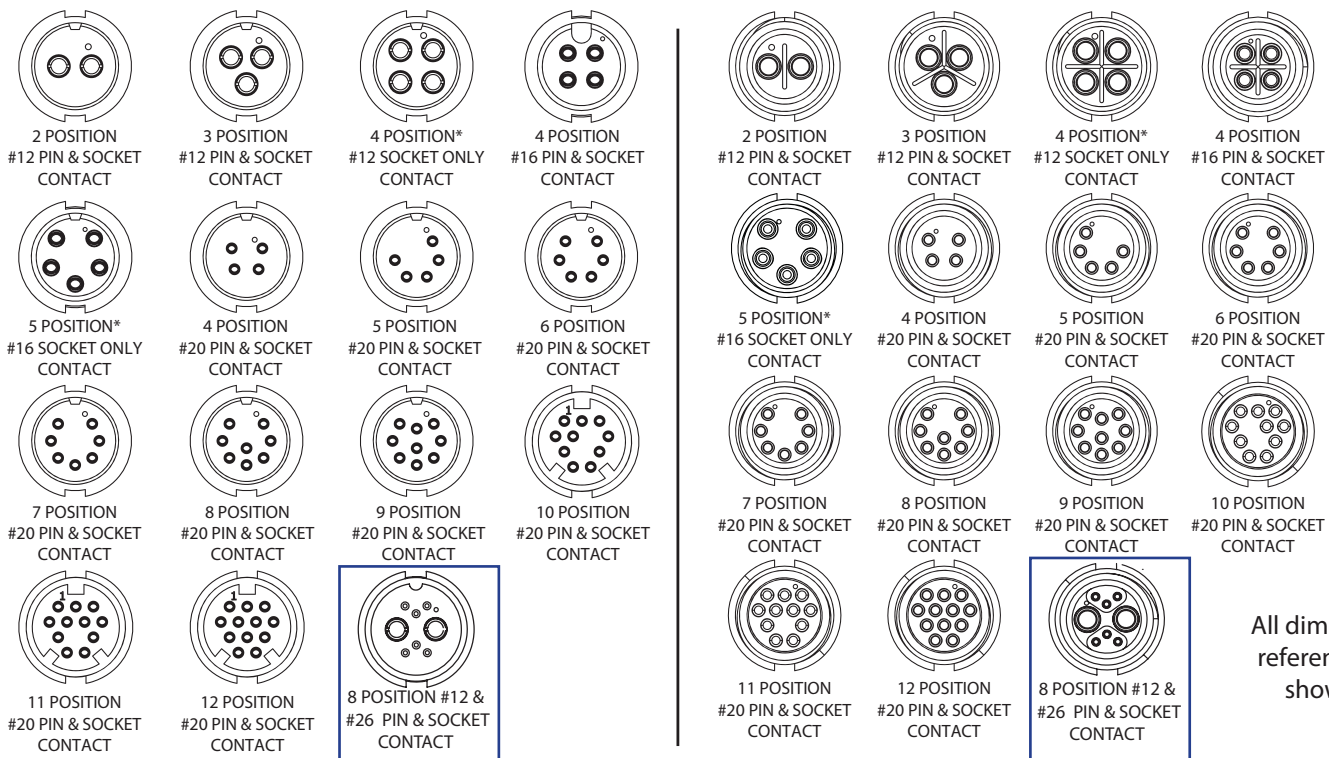

All dimensions are for reference only. Units shown: in[mm].

CUSTOM MOLDED CABLE ASSEMBLIES

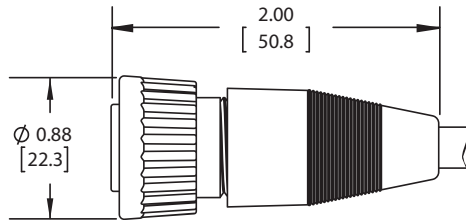

4XXX-XXG
CUSTOM CABLE CONNECTOR
STRAIGHT OVERMOLDED

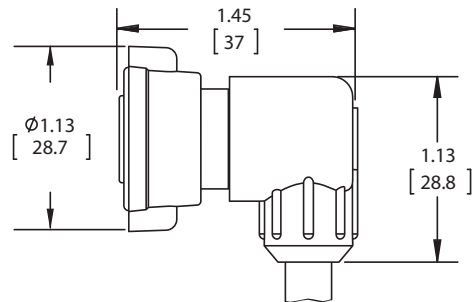

4XXX-XXG
CUSTOM CABLE CONNECTOR
RIGHT ANGLE OVERMOLDED

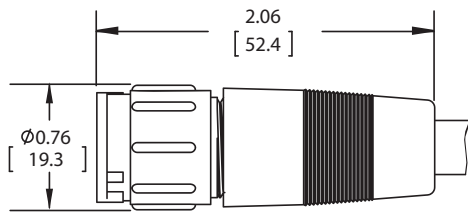

5XXX-XXG
CUSTOM CABLE TO CABLE CONNECTOR
STRAIGHT OVERMOLDED

Note: Multi-Con-X® can be overmolded onto an extended well panel mount. Straight version only.

- Available in: 5#20, 6#20 and 9#20 male
- Available in: 4#20 and 9#20 female

PART NUMBER TO ORDER: MULTI CON X®

W X X XX XXG - XXX - W

Special Features

BLANK - Standard Material
"W" - UV Resistant Material

Connector Type

3 - Cable End
4 - Panel mount
5 - Cable to Cable

Contact Size

1 - #12
2 - #20
3 - #16

Contact Style

8X - **"0"** - Crimp (supplied loose)
"1" - #20 PC Tail Short*
"2" - Solder Cup

9X - Extended PC Tail

"1" - #20 PC Tail Medium*
"2" - #20 PC Tail Long*

Special Features

"W" - Winged Coupling Nut

Backshell Style - Threaded w/ Grommet
 (Cable O.D. Range)

3XX: Weahertight Grommet Grip Seal

5XX: Mechanical Screw-Down Cable
 Clamp with Grommet Style

"15" - 0.15" - 0.17"

"18" - 0.18" - 0.20"

"21" - 0.21" - 0.23"

"24" - 0.24" - 0.27"

"28" - 0.28" - 0.29"

"30" - 0.30" - 0.32"

"35" - 0.35" - 0.37"

3DC: Daisy Chian Grommet w/ 3 IDS
 (0.125", 0.188", 0.250")

Panel Mount

300 - w/ Hex Nut & Gasket

3ES - 300 with Epoxy

Gold Plated

No. & Type of Contacts

Pins or Socket

***Mixed Contact and 10-12 position only available with UV resistant material**

***Consult factory for length and diameter of PC Tail.
 Additionally, alternative colors and materials are available.**

COLOR CODED CON-X® LINE



CC2



CH2



CC3



CH3



CC5



CH5



CC7



CH7

ORDERING CODE

Added to the end of your standard Con-X part number

When ordering, use the following code to specify your special feature:

Special Features

CXX= Color Options

- └─ Color Designator - see below
- └─ Part Designator - see below
- └─ Special Feature Designator - see below

Special Feature Designator = C (Color Option)

Part Designator = H (Hex Nut)

C (Coupling Ring-standard)*

Color Designator= 2 (Red)

3 (Blue)

5 (Yellow)

7 (Green)

*Winged coupling ring available on request.
Contact factory for more information.

SPECIFICATIONS

MECHANICAL:

Life:	300 insertion / withdrawal cycles minimum
Vibration:	Coupling rings have overriding locking feature to prevent loosening/separation of connector
Hex Nut Torque:	10 in-lb tightening torque
Coupling Locking Style:	Bayonet with ribbed coupling nut (winged coupling nut available) P/N 16482
Backshell Style:	Non-removable snap lock
Conductor Sizes:	#12 accepts 12 through 14 AWG #16 contacts accepts 16 through 18 AWG #20 contacts accepts 20 through 24 AWG

ELECTRICAL:

Voltage Rating:	600 V AC/DC Mixed Signal/Power: 300V
Current Rating:	23A Max (see electrical current rating chart)

ENVIRONMENTAL:

Operating Temperature:	-40°C to +85°C (-40°F to +185°F)
Salt Atmosphere (Corrosion):	300 Hr salt spray when mated
Weather-tight:	IP67 when mated

MATERIAL:

Backshell:	Thermoplastic, UL 94HB, Black
Contacts:	Copper Alloy, Gold over Nickel Plate
Coupling Ring:	Thermoplastic, UL 94HB, Black
Gasket:	Elastomer, Black
Grommet/ Strain Relief:	Elastomer, Black
Hex Nut:	Thermoplastic, UL 94HB, Black
O-Ring:	Elastomer, Black
Shell:	Thermoplastic, UL 94HB, Black
Optional Dust Cap:	Elastomer, Black

CON-X® ELECTRICAL CURRENT RATING CHART

CONTACT SIZE	CONDUCTOR SIZE - AWG	NUMBER OF CONDUCTORS	CURRENT RATING	
#12	#12	1 through 7	23.0A	
	#14	1 through 3	17.0A	
		4 through 6	12.75A	
		7 through 9	11.0A	
	#16	1 through 3	13.0A	
		4 through 6	9.75A	
		7	8.45A	
#16	#16	1 through 10	13.0A	
		11 and 12	7.5A	
	#18	1 through 3	10.0A	
		4 through 12	7.5A	
#20	#18	1 through 3	7.5A	
		4 through 20	5.6A	
		21 through 31	2.3A	
	#20	1 through 3	7.5A	
		4 through 20	5.6A	
		21 through 31	2.3A	
	#20 Multi-Con-X	10 through 12	5.0A	
	#22	#22	1 through 3	6.0A
			4 through 20	2.5A
			21 through 31	2.5A
	#24	#24	1 through 3	4.5A
			4 through 20	2.0A
21 through 31			1.5A	
#22	#22	4	5.5A	
	#24	4	5.0A	
#26	#24	5 to 6	4.0A	
	#24	7	3.5A	
	#26	5 to 6	2.5A	
	#26	7	2.5A	
	#28*	5 to 6	2.0A	
	#28*	7	2.0A	

*Not UL tested for this wire conductor size

Mouser Electronics

Authorized Distributor

Click to View Pricing, Inventory, Delivery & Lifecycle Information:

Switchcraft:

[5182-2PG-3DC](#) [5182-3PG-3DC](#) [3380-4PG-3XX](#) [3380-4PG-5XX](#) [3382-4PG-318](#) [3382-4PG-3XX](#) [3382-4PG-515](#)
[3382-4PG-518](#) [3382-4PG-5XX](#) [4281-4SG-300](#) [4281-6SG-300](#) [4281-8SG-300](#) [4292-9PG-300](#) [4380-4SG-300](#) [5180-](#)
[2SG-3XX](#) [5180-3SG-315](#) [5180-3SG-3XX](#) [5182-2PG-315](#) [5182-2PG-3XX](#) [5182-2SG-5XX](#) [5182-3PG-3XX](#) [5182-](#)
[3SG-5XX](#) [5182-4PG-3XX](#) [5380-4PG-5XX](#) [5380-4SG-3XX](#) [5380-4SG-515](#) [5380-4SG-5XX](#) [5380-5PG-5XX](#) [5380-](#)
[6PG-5XX](#) [5382-4PG-3XX](#) [5382-4SG-3DC](#) [5382-4SG-3XX](#) [5382-4SG-5XX](#) [5382-5PG-3XX](#) [3280-4SG-321](#) [3280-](#)
[4SG-3XX](#) [3280-5SG-3XX](#) [3280-6SG-3XX](#) [3280-7SG-3XX](#) [3280-8SG-3XX](#) [3280-9SG-315](#) [3280-9SG-324](#) [3280-](#)
[9SG-330](#) [3280-9SG-3XX](#) [4292-9SG-300](#)