

| Complete TIN | Product Number | Material Description | Resistance (mΩ) | Weight (g) (1000 pcs) |
|--------------|-------------------|------------------------------------|-----------------|-----------------------|
| 2176422-1 | TLRP3A30WR003FTE | TLRP 2512 3.0W R003 1% 75PPM | 3 | 52.6 |
| 2176422-2 | TLRP3A30WR010FTE | TLRP 2512 3.0W R010 1% 75PPM | 10 | 52.6 |
| 2176422-3 | TLRP3A30WR012FTE | TLRP 2512 3.0W R012 1% 75PPM | 12 | 52.6 |
| 2176422-4 | TLRP3A30WR015FTE | TLRP 2512 3.0W R015 1% 75PPM | 15 | 52.6 |
| 2176422-5 | TLRP3A30WR018FTE | TLRP 2512 3.0W R018 1% 75PPM | 18 | 52.6 |
| 2176422-6 | TLRP3A30WR020FTE | TLRP 2512 3.0W R020 1% 75PPM | 20 | 52.6 |
| 2176422-7 | TLRP3A30WR022FTE | TLRP 2512 3.0W R022 1% 75PPM | 22 | 52.6 |
| 2176422-8 | TLRP3A30WR030FTE | TLRP 2512 3.0W R030 1% 75PPM | 30 | 52.6 |
| 2176422-9 | TLRP3A30WR033FTE | TLRP 2512 3.0W R033 1% 75PPM | 33 | 52.6 |
| 1-2176422-0 | TLRP3A30WR039FTE | TLRP 2512 3.0W R039 1% 75PPM | 39 | 52.6 |
| 1-2176422-1 | TLRP3A30WR047FTE | TLRP 2512 3.0W R047 1% 75PPM | 47 | 52.6 |
| 1-2176422-2 | TLRP3A30WR068FTE | TLRP 2512 3.0W R068 1% 75PPM | 68 | 52.6 |
| 1-2176422-3 | TLRP3A30WR075FTE | TLRP 2512 3.0W R075 1% 75PPM | 75 | 52.6 |
| 1-2176422-4 | TLRP3A30WR082FTE | TLRP 2512 3.0W R082 1% 75PPM | 82 | 52.6 |
| 1-2176422-5 | TLRP3A30WR091FTE | TLRP 2512 3.0W R091 1% 75PPM | 91 | 52.6 |
| 1-2176422-6 | TLRP3A30WR100FTE | TLRP 2512 3.0W R100 1% 75PPM | 100 | 52.6 |
| 1-2176422-7 | TLRP3A30CR003FTDG | TLRP 2512 3.0W R003 1% 25PPM 2K RL | 3 | 52.6 |
| 1-2176422-8 | TLRP3A30CR004FTE | TLRP 2512 3.0W R004 1% 25PPM 4K RL | 4 | 52.6 |
| 1-2176422-9 | TLRP3A30CR005FTE | TLRP 2512 3.0W R005 1% 25PPM 4K RL | 5 | 52.6 |
| 2-2176422-0 | TLRP3A30CR006FTE | TLRP 2512 3.0W R006 1% 25PPM 4K RL | 6 | 52.6 |
| 2-2176422-1 | TLRP3A30CR007FTE | TLRP 2512 3.0W R007 1% 25PPM 4K RL | 7 | 52.6 |
| 2-2176422-2 | TLRP3A30CR018FTE | TLRP 2512 3.0W R018 1% 25PPM 4K RL | 18 | 52.6 |
| 2-2176422-3 | TLRP3A30CR020FTE | TLRP 2512 3.0W R020 1% 25PPM 4K RL | 20 | 52.6 |
| 2-2176422-4 | TLRP3A30CR022FTE | TLRP 2512 3.0W R022 1% 25PPM 4K RL | 22 | 52.6 |
| 2-2176422-5 | TLRP3A30CR025FTE | TLRP 2512 3.0W R025 1% 25PPM 4K RL | 25 | 52.6 |
| 2-2176422-6 | TLRP3A30CR030FTE | TLRP 2512 3.0W R030 1% 25PPM 4K RL | 30 | 52.6 |
| 2-2176422-7 | TLRP3A30CR033FTE | TLRP 2512 3.0W R033 1% 25PPM 4K RL | 33 | 52.6 |
| 2-2176422-8 | TLRP3A30CR035FTE | TLRP 2512 3.0W R035 1% 25PPM 4K RL | 35 | 52.6 |
| 2-2176422-9 | TLRP3A30CR039FTE | TLRP 2512 3.0W R039 1% 25PPM 4K RL | 39 | 52.6 |
| 3-2176422-0 | TLRP3A30CR040FTE | TLRP 2512 3.0W R040 1% 25PPM 4K RL | 40 | 52.6 |
| 3-2176422-1 | TLRP3A30CR047FTE | TLRP 2512 3.0W R047 1% 25PPM 4K RL | 47 | 52.6 |
| 3-2176422-2 | TLRP3A30CR050FTE | TLRP 2512 3.0W R050 1% 25PPM 4K RL | 50 | 52.6 |
| 3-2176422-3 | TLRP3A30CR060FTE | TLRP 2512 3.0W R060 1% 25PPM 4K RL | 60 | 52.6 |
| 3-2176422-5 | TLRP3A30CR068FTE | TLRP 2512 3.0W R068 1% 25PPM 4K RL | 68 | 52.6 |
| 3-2176422-6 | TLRP3A30CR070FTE | TLRP 2512 3.0W R070 1% 25PPM 4K RL | 70 | 52.6 |
| 3-2176422-7 | TLRP3A30CR075FTE | TLRP 2512 3.0W R075 1% 25PPM 4K RL | 75 | 52.6 |
| 3-2176422-8 | TLRP3A30CR080FTE | TLRP 2512 3.0W R080 1% 25PPM 4K RL | 80 | 52.6 |
| 3-2176422-9 | TLRP3A30CR082FTE | TLRP 2512 3.0W R082 1% 25PPM 4K RL | 82 | 52.6 |
| 4-2176422-0 | TLRP3A30CR090FTE | TLRP 2512 3.0W R090 1% 25PPM 4K RL | 90 | 52.6 |

...CONTINUED IN NEXT SHEET

REVISIONS

| P | LTR | DESCRIPTION | DATE | DWN | APVD |
|---|-----|-----------------|-----------|-----|------|
| | A | INITIAL RELEASE | 03APR2019 | SR | AP |
| | A1 | ECR-21-104321 | 26MAY2021 | MHS | AP |

FOR FURTHER INFORMATION SEE DATA SHEET FOR TLRP SERIES-SMD HIGH POWER CURRENT SENSE RESISTORS

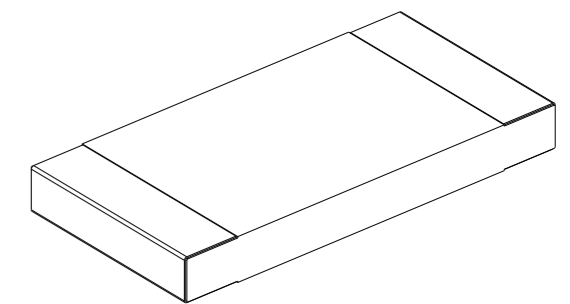
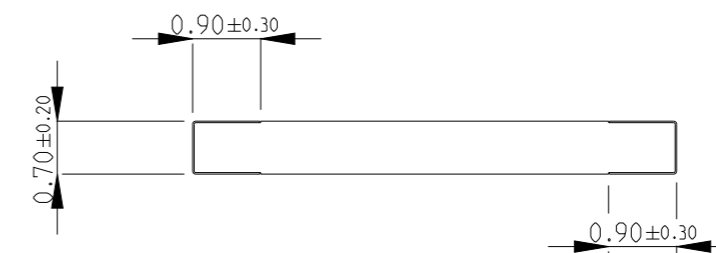
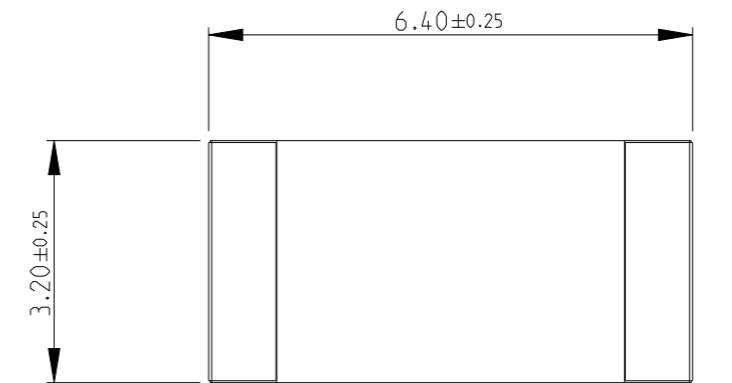

RoHS Compliant

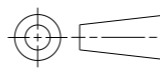
| | | | | | |
|---|--|--------------------------|---|-----------------|----------------------|
| THIS DRAWING IS A CONTROLLED DOCUMENT. | | DWN SUPREETH R 03APR2019 |  TE Connectivity | | |
| DIMENSIONS: mm | | CHK A. PILE 03APR2019 | | | |
| TOLERANCES UNLESS OTHERWISE SPECIFIED: | | APVD A. PILE 03APR2019 | NAME SMD HIGH POWER - CURRENT SENSE RESISTORS, SERIES TLRP - 3A | | |
|  0 PLC ±0.2 1 PLC ±0.1 2 PLC ± 3 PLC ± 4 PLC ± ANGLES ±5° | | PRODUCT SPEC - | RESTRICTED TO | | |
| MATERIAL - | | APPLICATION SPEC - | SIZE A3 | CAGE CODE 00779 | DRAWING NO C-2176422 |
| FINISH - | | WEIGHT - | CUSTOMER DRAWING | | |
| | | SCALE 10:1 | SHEET 1 OF 2 | REV A1 | |

REVISIONS

| P | LTR | DESCRIPTION | DATE | DWN | APVD |
|---|-----|-------------|------|-----|------|
| - | - | SEE SHEET 1 | - | - | - |
| | | | | | |
| | | | | | |

| Complete TIN | Product Number | Material Description | Resistance (mΩ) | Weight (g) (1000 pcs) |
|--------------|-------------------|------------------------------------|-----------------|-----------------------|
| 4-2176422-1 | TLRP3A30CR091FTE | TLRP 2512 3.0W R091 1% 25PPM 4K RL | 91 | 52.6 |
| 4-2176422-2 | TLRP3A30CR100FTE | TLRP 2512 3.0W R100 1% 25PPM 4K RL | 100 | 52.6 |
| 4-2176422-3 | TLRP3A30CR120FTE | TLRP 2512 3.0W R120 1% 25PPM 4K RL | 120 | 52.6 |
| 4-2176422-4 | TLRP3A30CR150FTE | TLRP 2512 3.0W R150 1% 25PPM 4K RL | 150 | 52.6 |
| 4-2176422-5 | TLRP3A30CR180FTE | TLRP 2512 3.0W R180 1% 25PPM 4K RL | 180 | 52.6 |
| 4-2176422-6 | TLRP3A30CR200FTE | TLRP 2512 3.0W R200 1% 25PPM 4K RL | 200 | 52.6 |
| 4-2176422-7 | TLRP3A30DR003FTDG | TLRP 2512 3.0W R003 1% 50PPM 2K RL | 3 | 52.6 |
| 4-2176422-8 | TLRP3A30DR004FTE | TLRP 2512 3.0W R004 1% 50PPM 4K RL | 4 | 52.6 |
| 4-2176422-9 | TLRP3A30DR005FTE | TLRP 2512 3.0W R005 1% 50PPM 4K RL | 5 | 52.6 |
| 5-2176422-0 | TLRP3A30DR006FTE | TLRP 2512 3.0W R006 1% 50PPM 4K RL | 6 | 52.6 |
| 5-2176422-1 | TLRP3A30DR007FTE | TLRP 2512 3.0W R007 1% 50PPM 4K RL | 7 | 52.6 |
| 5-2176422-2 | TLRP3A30DR008FTE | TLRP 2512 3.0W R008 1% 50PPM 4K RL | 8 | 52.6 |
| 5-2176422-3 | TLRP3A30DR009FTE | TLRP 2512 3.0W R009 1% 50PPM 4K RL | 9 | 52.6 |
| 5-2176422-4 | TLRP3A30DR010FTE | TLRP 2512 3.0W R010 1% 50PPM 4K RL | 10 | 52.6 |
| 5-2176422-5 | TLRP3A30DR012FTE | TLRP 2512 3.0W R012 1% 50PPM 4K RL | 12 | 52.6 |
| 5-2176422-6 | TLRP3A30DR015FTE | TLRP 2512 3.0W R015 1% 50PPM 4K RL | 15 | 52.6 |
| 5-2176422-7 | TLRP3A30DR018FTE | TLRP 2512 3.0W R018 1% 50PPM 4K RL | 18 | 52.6 |
| 5-2176422-8 | TLRP3A30DR020FTE | TLRP 2512 3.0W R020 1% 50PPM 4K RL | 20 | 52.6 |
| 5-2176422-9 | TLRP3A30DR022FTE | TLRP 2512 3.0W R022 1% 50PPM 4K RL | 22 | 52.6 |
| 6-2176422-0 | TLRP3A30DR025FTE | TLRP 2512 3.0W R025 1% 50PPM 4K RL | 25 | 52.6 |
| 6-2176422-1 | TLRP3A30DR030FTE | TLRP 2512 3.0W R030 1% 50PPM 4K RL | 30 | 52.6 |
| 6-2176422-2 | TLRP3A30DR033FTE | TLRP 2512 3.0W R033 1% 50PPM 4K RL | 33 | 52.6 |
| 6-2176422-3 | TLRP3A30DR035FTE | TLRP 2512 3.0W R035 1% 50PPM 4K RL | 35 | 52.6 |
| 6-2176422-4 | TLRP3A30DR039FTE | TLRP 2512 3.0W R039 1% 50PPM 4K RL | 39 | 52.6 |
| 6-2176422-5 | TLRP3A30DR040FTE | TLRP 2512 3.0W R040 1% 50PPM 4K RL | 40 | 52.6 |
| 6-2176422-6 | TLRP3A30DR047FTE | TLRP 2512 3.0W R047 1% 50PPM 4K RL | 47 | 52.6 |
| 6-2176422-7 | TLRP3A30DR050FTE | TLRP 2512 3.0W R050 1% 50PPM 4K RL | 50 | 52.6 |
| 6-2176422-8 | TLRP3A30DR060FTE | TLRP 2512 3.0W R060 1% 50PPM 4K RL | 60 | 52.6 |
| 6-2176422-9 | TLRP3A30DR068FTE | TLRP 2512 3.0W R068 1% 50PPM 4K RL | 68 | 52.6 |
| 7-2176422-0 | TLRP3A30DR070FTE | TLRP 2512 3.0W R070 1% 50PPM 4K RL | 70 | 52.6 |
| 7-2176422-1 | TLRP3A30DR075FTE | TLRP 2512 3.0W R075 1% 50PPM 4K RL | 75 | 52.6 |
| 7-2176422-2 | TLRP3A30DR080FTE | TLRP 2512 3.0W R080 1% 50PPM 4K RL | 80 | 52.6 |
| 7-2176422-3 | TLRP3A30DR082FTE | TLRP 2512 3.0W R082 1% 50PPM 4K RL | 82 | 52.6 |
| 7-2176422-4 | TLRP3A30DR090FTE | TLRP 2512 3.0W R090 1% 50PPM 4K RL | 90 | 52.6 |
| 7-2176422-5 | TLRP3A30DR091FTE | TLRP 2512 3.0W R091 1% 50PPM 4K RL | 91 | 52.6 |
| 7-2176422-6 | TLRP3A30DR100FTE | TLRP 2512 3.0W R100 1% 50PPM 4K RL | 100 | 52.6 |
| 7-2176422-7 | TLRP3A30DR120FTE | TLRP 2512 3.0W R120 1% 50PPM 4K RL | 120 | 52.6 |
| 7-2176422-8 | TLRP3A30DR150FTE | TLRP 2512 3.0W R150 1% 50PPM 4K RL | 150 | 52.6 |
| 7-2176422-9 | TLRP3A30DR180FTE | TLRP 2512 3.0W R180 1% 50PPM 4K RL | 180 | 52.6 |
| 8-2176422-0 | TLRP3A30DR200FTE | TLRP 2512 3.0W R200 1% 50PPM 4K RL | 200 | 52.6 |

| Complete TIN | Product Number | Material Description | Resistance (mΩ) | Weight (g) (1000 pcs) |
|--------------|------------------|------------------------------------|-----------------|-----------------------|
| 8-2176422-1 | TLRP3A30WR004FTE | TLRP 2512 3.0W R004 1% 75PPM 4K RL | 4 | 52.6 |
| 8-2176422-2 | TLRP3A30WR005FTE | TLRP 2512 3.0W R005 1% 75PPM 4K RL | 5 | 52.6 |
| 8-2176422-3 | TLRP3A30WR006FTE | TLRP 2512 3.0W R006 1% 75PPM 4K RL | 6 | 52.6 |
| 8-2176422-4 | TLRP3A30WR007FTE | TLRP 2512 3.0W R007 1% 75PPM 4K RL | 7 | 52.6 |
| 8-2176422-5 | TLRP3A30WR008FTE | TLRP 2512 3.0W R008 1% 75PPM 4K RL | 8 | 52.6 |
| 8-2176422-6 | TLRP3A30WR009FTE | TLRP 2512 3.0W R009 1% 75PPM 4K RL | 9 | 52.6 |
| 8-2176422-7 | TLRP3A30WR025FTE | TLRP 2512 3.0W R025 1% 75PPM 4K RL | 25 | 52.6 |
| 8-2176422-8 | TLRP3A30WR035FTE | TLRP 2512 3.0W R035 1% 75PPM 4K RL | 35 | 52.6 |
| 8-2176422-9 | TLRP3A30WR040FTE | TLRP 2512 3.0W R040 1% 75PPM 4K RL | 40 | 52.6 |
| 9-2176422-0 | TLRP3A30WR050FTE | TLRP 2512 3.0W R050 1% 75PPM 4K RL | 50 | 52.6 |
| 9-2176422-1 | TLRP3A30WR060FTE | TLRP 2512 3.0W R060 1% 75PPM 4K RL | 60 | 52.6 |
| 9-2176422-2 | TLRP3A30WR070FTE | TLRP 2512 3.0W R070 1% 75PPM 4K RL | 70 | 52.6 |
| 9-2176422-3 | TLRP3A30WR080FTE | TLRP 2512 3.0W R080 1% 75PPM 4K RL | 80 | 52.6 |
| 9-2176422-4 | TLRP3A30WR090FTE | TLRP 2512 3.0W R090 1% 75PPM 4K RL | 90 | 52.6 |
| 9-2176422-5 | TLRP3A30WR120FTE | TLRP 2512 3.0W R120 1% 75PPM 4K RL | 120 | 52.6 |
| 9-2176422-6 | TLRP3A30WR150FTE | TLRP 2512 3.0W R150 1% 75PPM 4K RL | 150 | 52.6 |
| 9-2176422-7 | TLRP3A30WR180FTE | TLRP 2512 3.0W R180 1% 75PPM 4K RL | 180 | 52.6 |
| 9-2176422-8 | TLRP3A30WR200FTE | TLRP 2512 3.0W R200 1% 75PPM 4K RL | 200 | 52.6 |

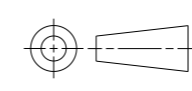
| | | | | |
|---|--|--------------------------|---|-----------------|
| THIS DRAWING IS A CONTROLLED DOCUMENT. | | DWN SUPREETH R 03APR2019 |  TE Connectivity | |
| DIMENSIONS: mm | | CHK A. PILE 03APR2019 | | |
| TOLERANCES UNLESS OTHERWISE SPECIFIED: | | APVD A. PILE 03APR2019 | NAME SMD HIGH POWER - CURRENT SENSE RESISTORS, SERIES TLRP - 3A | |
|  | | PRODUCT SPEC - | RESTRICTED TO | |
| MATERIAL - | | APPLICATION SPEC - | SIZE A3 | CAGE CODE 00779 |
| FINISH - | | WEIGHT - | DRAWING NO C-2176422 | |
| | | CUSTOMER DRAWING | SCALE 10:1 | SHEET 2 OF 2 |
| | | | REV A1 | |