

Metallized Polypropylene Film Capacitor

Type : **ECWH(V)**

Designed for high frequency and pluse applications.

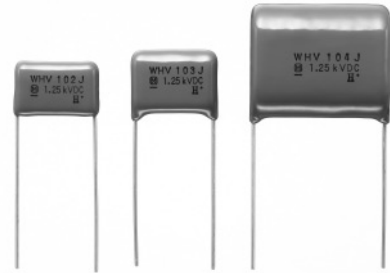

■ **Features**

- Low-loss and inherent temperature rise
- Excellent electrical characteristics
- Flame-retardant epoxy resin coating
- RoHS directive compliant

■ **Recommended Applications**

- TV, Monitors, Electronic ballast

■ **Explanation of Part Numbers**

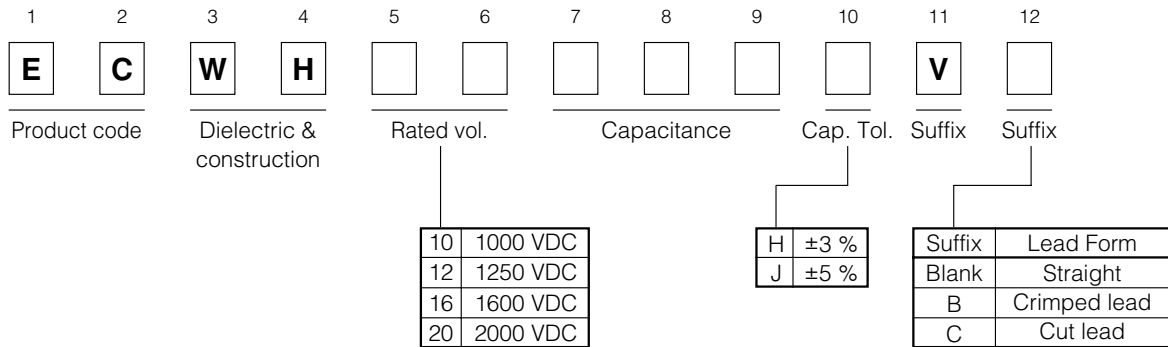

Metallized Film

● **Explanation of Part Number for Odd Size Taping**

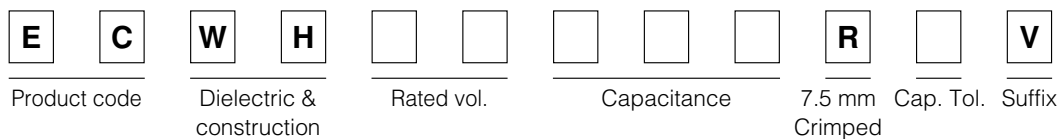

■ **Specifications**

Category temp. range (Including temperature-rise on unit surface)	-40 °C to +105 °C	
Rated voltage	1000 VDC, 1250 VDC (1000 Vp-p), 1600 VDC (1200 Vp-p), 2000 VDC (1500 Vp-p) (Derating of rated voltage by 1.25 %/°C at more than 85 °C)	
Capacitance range	1000 VDC	0.0075 μF to 0.10 μF
	1250 VDC	0.0036 μF to 0.10 μF
	1600 VDC	0.0013 μF to 0.056 μF
	2000 VDC	0.0010 μF to 0.015 μF
Capacitance tolerance	±3 % (H), ±5 % (J)	
Dissipation factor (tan δ)	tan δ ≤ 0.1 % (20 °C, 1 kHz), tan δ ≤ 0.2 % (20 °C, 10 kHz)	
Withstand voltage	Between terminals: Rated volt. (VDC) × 150 % 60 s Between terminals to enclosure: 1500 VAC 60 s	
Insulation resistance (IR)	IR ≥ 30000 MΩ (20 °C, 500 VDC, 60 s)	

* In case of applying voltage in alternating current (50 Hz or 60 Hz sine wave) to a capacitor with DC rated voltage, please refer to the page of "Permissible voltage (R.M.S) in alternating current corresponding to DC rated voltage".

Design, Specifications are subject to change without notice. Ask factory for technical specifications before purchase and/or use. Whenever a doubt about safety arises from this product, please inform us immediately for technical consultation without fail.

■ Dimensions in mm (not to scale)

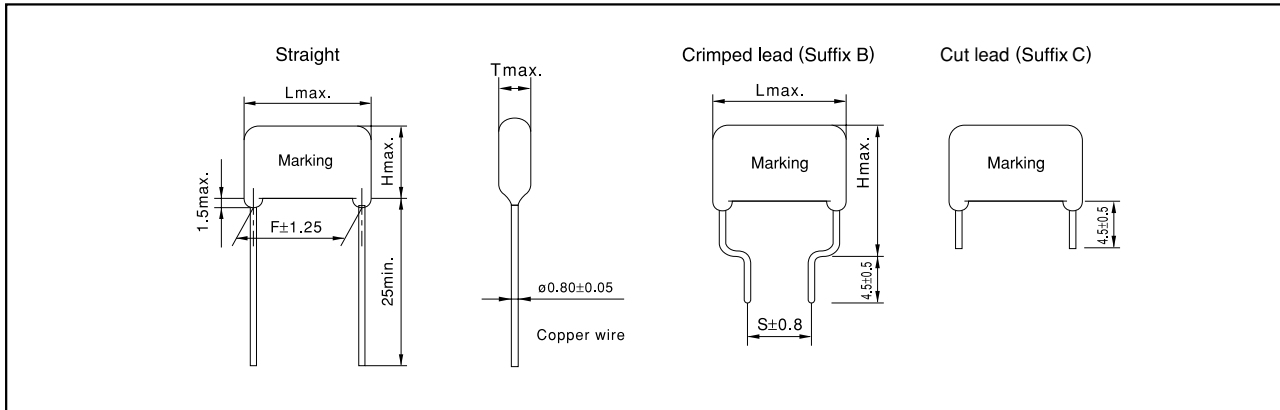

■ Packaging Specifications for Bulk Package

Packing quantity : 100 pcs./bag

■ Taping Specifications for Automatic Insertion

● Taping style

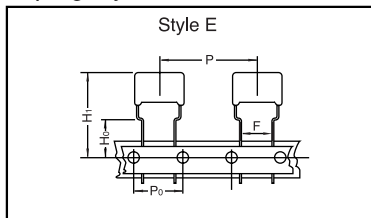

*Refer to the page of taping specifications.

● Packaging Specifications

Type	Rated volt.	Cap. range (μF)	Taping style					Packing	suffix	
			AD	AS	B	C	D			E
ECWH(V)	1000 VDC	0.0075 to 0.10						○	Ammo	R() V
	1250 VDC	0.0036 to 0.051						○	Ammo	R() V
	1600 VDC	0.0013 to 0.020						○	Ammo	R() V
	2000 VDC	0.0010 to 0.015						○	Ammo	R() V

● Lead Spacing

Style	Lead Spacing
E	7.5 mm

*See the column "Rating, Dimensions & Quantity Box" for packing quantity.

■ Rating & Dimensions

● Rated voltage : 1000 VDC. Capacitance tolerance : ±3 % (H), ±5 % (J)

Part No.	Cap. (μF)	Dimensions (mm)							Min. order Q'ty		
		L _{max}	T _{max}	H _{max}		F	S		ød	Taping 7.5 mm	Bulk
				Straight	Crimped lead		Straight	Crimped lead			
ECWH10752□V()	0.0075	18.0	6.0	12.5	17.5	15.0	10.0	0.80	500	500	
ECWH10822□V()	0.0082	18.0	6.0	12.5	17.5	15.0	10.0	0.80			
ECWH10912□V()	0.0091	18.0	6.0	13.0	18.0	15.0	10.0	0.80			
ECWH10103□V()	0.010	18.0	6.5	13.0	18.0	15.0	10.0	0.80			
ECWH10113□V()	0.011	18.0	6.5	13.5	18.5	15.0	10.0	0.80			
ECWH10123□V()	0.012	18.0	6.5	13.5	18.5	15.0	10.0	0.80			
ECWH10133□V()	0.013	18.0	7.0	13.5	18.5	15.0	10.0	0.80			
ECWH10153□V()	0.015	18.0	7.0	14.0	19.0	15.0	10.0	0.80			
ECWH10163□V()	0.016	18.0	7.5	14.0	19.0	15.0	10.0	0.80			
ECWH10183□V()	0.018	18.0	7.5	14.5	19.5	15.0	10.0	0.80			
ECWH10203□V()	0.020	18.0	8.0	15.0	20.0	15.0	10.0	0.80	400	500	
ECWH10223□V()	0.022	18.0	8.5	15.0	20.0	15.0	10.0	0.80			
ECWH10243□V()	0.024	18.0	8.5	15.5	20.5	15.0	10.0	0.80			
ECWH10273□V()	0.027	18.0	9.0	16.0	21.0	15.0	10.0	0.80	300	500	
ECWH10303□V()	0.030	18.0	9.5	16.5	21.5	15.0	10.0	0.80			
ECWH10333□V()	0.033	23.0	7.5	16.0	21.0	20.0	15.0	0.80	400		
ECWH10363□V()	0.036	23.0	7.5	16.0	21.0	20.0	15.0	0.80			
ECWH10393□V()	0.039	23.0	8.0	16.5	21.5	20.0	15.0	0.80			
ECWH10433□V()	0.043	23.0	8.5	16.5	21.5	20.0	15.0	0.80			
ECWH10473□V()	0.047	23.0	8.5	17.0	22.0	20.0	15.0	0.80	300		
ECWH10513□V()	0.051	23.0	9.0	17.5	22.5	20.0	15.0	0.80			
ECWH10563□V()	0.056	23.0	9.5	17.5	22.5	20.0	15.0	0.80			
ECWH10623□V()	0.062	23.0	9.5	18.0	23.0	20.0	15.0	0.80			
ECWH10683□V()	0.068	23.0	10.0	19.0	24.0	20.0	15.0	0.80			
ECWH10753□V()	0.075	23.0	10.5	19.5	24.5	20.0	15.0	0.80			
ECWH10823□V()	0.082	23.0	11.0	20.0	25.0	20.0	15.0	0.80			
ECWH10913□V()	0.091	23.0	11.5	20.5	25.5	20.0	15.0	0.80			
ECWH10104□V()	0.10	23.0	12.0	21.0	26.0	20.0	15.0	0.80			

Suffix for lead crimped
 Cap. tol. code

Metallized Film

■ Rating & Dimensions

● Rated voltage : 1250 VDC Capacitance tolerance : $\pm 3\%$ (H), $\pm 5\%$ (J)

Part No.	Cap. (μ F)	Dimensions (mm)							Min. order Q'ty		
		L _{max}	T _{max}	H _{max}		F		S	ϕ d	Taping 7.5 mm	Bulk
				Straight	Crimped lead	Straight	Crimped lead	Crimped lead			
ECWH12362□V()	0.0036	18.0	6.0	12.5	17.5	15.0	10.0	0.80	500		
ECWH12392□V()	0.0039	18.0	6.0	12.5	17.5	15.0	10.0	0.80			
ECWH12432□V()	0.0043	18.0	6.0	13.0	18.0	15.0	10.0	0.80			
ECWH12472□V()	0.0047	18.0	6.0	13.0	18.0	15.0	10.0	0.80			
ECWH12512□V()	0.0051	18.0	6.5	13.0	18.0	15.0	10.0	0.80			
ECWH12562□V()	0.0056	18.0	6.5	13.5	18.5	15.0	10.0	0.80			
ECWH12622□V()	0.0062	18.0	6.5	13.5	18.5	15.0	10.0	0.80			
ECWH12682□V()	0.0068	18.0	7.0	13.5	18.5	15.0	10.0	0.80			
ECWH12752□V()	0.0075	18.0	7.0	14.0	19.0	15.0	10.0	0.80			
ECWH12822□V()	0.0082	18.0	7.5	14.0	19.0	15.0	10.0	0.80			
ECWH12912□V()	0.0091	18.0	7.5	14.5	19.5	15.0	10.0	0.80			
ECWH12103□V()	0.010	18.0	8.0	15.0	20.0	15.0	10.0	0.80			
ECWH12113□V()	0.011	18.0	8.5	15.0	20.0	15.0	10.0	0.80			
ECWH12123□V()	0.012	18.0	8.5	15.5	20.5	15.0	10.0	0.80			
ECWH12133□V()	0.013	18.0	9.0	15.5	20.5	15.0	10.0	0.80			
ECWH12153□V()	0.015	18.0	9.5	16.0	21.0	15.0	10.0	0.80			
ECWH12163□V()	0.016	23.0	7.5	16.0	21.0	20.0	15.0	0.80			
ECWH12183□V()	0.018	23.0	7.5	16.0	21.0	20.0	15.0	0.80			
ECWH12203□V()	0.020	23.0	8.0	16.5	21.5	20.0	15.0	0.80			
ECWH12223□V()	0.022	23.0	8.5	16.5	21.5	20.0	15.0	0.80			
ECWH12243□V()	0.024	23.0	8.5	17.0	22.0	20.0	15.0	0.80			
ECWH12273□V()	0.027	23.0	9.0	17.5	22.5	20.0	15.0	0.80			
ECWH12303□V()	0.030	23.0	9.5	18.0	23.0	20.0	15.0	0.80			
ECWH12333□V()	0.033	23.0	10.0	18.5	23.5	20.0	15.0	0.80			
ECWH12363□V()	0.036	23.0	10.0	19.0	24.0	20.0	15.0	0.80			
ECWH12393□V()	0.039	23.0	10.5	19.5	24.5	20.0	15.0	0.80			
ECWH12433□V()	0.043	23.0	11.0	20.0	25.0	20.0	15.0	0.80			
ECWH12473□V()	0.047	23.0	11.5	20.5	25.5	20.0	15.0	0.80			
ECWH12513□V()	0.051	23.0	12.0	21.0	26.0	20.0	15.0	0.80			
ECWH12563□V()	0.056	28.0	11.5	20.0	25.0	25.0	17.5	0.80			
ECWH12623□V()	0.062	28.0	12.0	21.0	26.0	25.0	17.5	0.80			
ECWH12683□V()	0.068	28.0	12.5	21.5	26.5	25.0	17.5	0.80			
ECWH12753□V()	0.075	28.0	13.5	22.0	27.0	25.0	17.5	0.80			
ECWH12823□V()	0.082	28.0	14.0	22.5	27.5	25.0	17.5	0.80			
ECWH12913□V()	0.091	28.0	14.5	23.0	28.0	25.0	17.5	0.80			
ECWH12104□V()	0.10	28.0	15.5	24.0	29.0	25.0	17.5	0.80			

Suffix for lead crimped
 Cap. tol. code

■ Rating & Dimensions

● Rated voltage : 1600 VDC Capacitance tolerance : $\pm 3\%$ (H), $\pm 5\%$ (J)

Part No.	Cap. (μ F)	Dimensions (mm)							Min. order Q'ty		
		L _{max}	T _{max}	H _{max}		F		S		Taping 7.5 mm	Bulk
				Straight	Crimped lead	Straight	Crimped lead	Straight	Crimped lead		
ECWH16132□V()	0.0013	18.0	6.5	13.0	18.0	15.0	10.0	0.80	500		
ECWH16152□V()	0.0015	18.0	6.5	13.5	18.5	15.0	10.0	0.80			
ECWH16162□V()	0.0016	18.0	7.0	13.5	18.5	15.0	10.0	0.80			
ECWH16182□V()	0.0018	18.0	7.0	14.0	19.0	15.0	10.0	0.80			
ECWH16202□V()	0.0020	18.0	7.0	14.0	19.0	15.0	10.0	0.80			
ECWH16222□V()	0.0022	18.0	6.5	13.5	18.5	15.0	10.0	0.80			
ECWH16242□V()	0.0024	18.0	7.0	13.5	18.5	15.0	10.0	0.80			
ECWH16272□V()	0.0027	18.0	7.0	14.0	19.0	15.0	10.0	0.80			
ECWH16302□V()	0.0030	18.0	7.5	14.0	19.0	15.0	10.0	0.80	400		
ECWH16332□V()	0.0033	18.0	7.5	14.5	19.5	15.0	10.0	0.80			
ECWH16362□V()	0.0036	18.0	7.0	13.5	18.5	15.0	10.0	0.80	500		
ECWH16392□V()	0.0039	18.0	7.0	14.0	19.0	15.0	10.0	0.80			
ECWH16432□V()	0.0043	18.0	7.0	14.0	19.0	15.0	10.0	0.80			
ECWH16472□V()	0.0047	23.0	6.5	14.5	19.5	20.0	15.0	0.80			
ECWH16512□V()	0.0051	23.0	6.5	15.0	20.0	20.0	15.0	0.80			
ECWH16562□V()	0.0056	23.0	6.5	15.0	20.0	20.0	15.0	0.80			
ECWH16622□V()	0.0062	23.0	7.0	15.0	20.0	20.0	15.0	0.80			
ECWH16682□V()	0.0068	23.0	7.0	15.5	20.5	20.0	15.0	0.80			
ECWH16752□V()	0.0075	23.0	7.5	15.5	20.5	20.0	15.0	0.80	400	500	
ECWH16822□V()	0.0082	23.0	7.5	16.0	21.0	20.0	15.0	0.80			
ECWH16912□V()	0.0091	23.0	8.0	16.0	21.0	20.0	15.0	0.80			
ECWH16103□V()	0.010	23.0	8.0	16.5	21.5	20.0	15.0	0.80			
ECWH16113□V()	0.011	23.0	8.5	17.0	22.0	20.0	15.0	0.80	300		
ECWH16123□V()	0.012	23.0	9.0	17.0	22.0	20.0	15.0	0.80			
ECWH16133□V()	0.013	23.0	9.0	17.5	22.5	20.0	15.0	0.80			
ECWH16153□V()	0.015	23.0	9.5	18.0	23.0	20.0	15.0	0.80			
ECWH16163□V()	0.016	23.0	10.0	18.5	23.5	20.0	15.0	0.80			
ECWH16183□V()	0.018	23.0	10.5	19.5	24.5	20.0	15.0	0.80			
ECWH16203□V()	0.020	23.0	11.0	20.0	25.0	20.0	15.0	0.80			
ECWH16223□V()	0.022	28.0	9.5	18.0	23.0	25.0	17.5	0.80			—
ECWH16243□V()	0.024	28.0	10.0	18.5	23.5	25.0	17.5	0.80			
ECWH16273□V()	0.027	28.0	10.5	19.5	24.5	25.0	17.5	0.80			
ECWH16303□V()	0.030	28.0	11.0	20.0	25.0	25.0	17.5	0.80			
ECWH16333□V()	0.033	28.0	11.5	20.5	25.5	25.0	17.5	0.80			
ECWH16363□V()	0.036	28.0	12.5	21.5	26.5	25.0	17.5	0.80			
ECWH16393□V()	0.039	28.0	13.5	22.0	27.0	25.0	17.5	0.80			
ECWH16433□V()	0.043	28.0	14.5	22.5	27.5	25.0	17.5	0.80			
ECWH16473□V()	0.047	28.0	15.0	23.5	28.5	25.0	17.5	0.80			
ECWH16513□V()	0.051	28.0	15.5	24.0	29.0	25.0	17.5	0.80			
ECWH16563□V()	0.056	28.0	16.0	24.5	29.5	25.0	17.5	0.80			

Suffix for lead crimped
 Cap. tol. code

Metallized Film

■ Rating & Dimensions

● Rated voltage : 2000 VDC Capacitance tolerance : $\pm 3\%$ (H), $\pm 5\%$ (J)

Part No.	Cap. (μF)	Dimensions							Min. order Q'ty		
		L _{max}	T _{max}	H _{max}		F		S		Taping 7.5 mm	Bulk
				Straight	Crimped lead	Straight	Crimped lead	ød			
ECWH20102□V()	0.0010	18.0	6.5	13.5	18.5	15.0	10.0	0.80	500	500	
ECWH20112□V()	0.0011	18.0	6.5	13.5	18.5	15.0	10.0	0.80			
ECWH20122□V()	0.0012	18.0	7.0	13.5	18.5	15.0	10.0	0.80			
ECWH20132□V()	0.0013	18.0	7.0	14.0	19.0	15.0	10.0	0.80			
ECWH20152□V()	0.0015	18.0	7.5	14.0	19.0	15.0	10.0	0.80	400		
ECWH20162□V()	0.0016	18.0	7.5	14.5	19.5	15.0	10.0	0.80			
ECWH20182□V()	0.0018	18.0	8.0	14.5	19.5	15.0	10.0	0.80			
ECWH20202□V()	0.0020	18.0	8.0	15.0	20.0	15.0	10.0	0.80			
ECWH20222□V()	0.0022	18.0	8.5	15.0	20.0	15.0	10.0	0.80	300		
ECWH20242□V()	0.0024	18.0	8.5	15.5	20.5	15.0	10.0	0.80			
ECWH20272□V()	0.0027	18.0	9.0	16.0	21.0	15.0	10.0	0.80			
ECWH20302□V()	0.0030	18.0	9.5	16.0	21.0	15.0	10.0	0.80			
ECWH20332□V()	0.0033	18.0	8.5	15.5	20.5	15.0	10.0	0.80	400		
ECWH20362□V()	0.0036	18.0	9.0	15.5	20.5	15.0	10.0	0.80			
ECWH20392□V()	0.0039	18.0	9.0	16.0	21.0	15.0	10.0	0.80	300		
ECWH20432□V()	0.0043	18.0	9.5	16.0	21.0	15.0	10.0	0.80			
ECWH20472□V()	0.0047	23.0	7.0	15.5	20.5	20.0	15.0	0.80	500		
ECWH20512□V()	0.0051	23.0	7.5	16.0	21.0	20.0	15.0	0.80			
ECWH20562□V()	0.0056	23.0	7.5	16.0	21.0	20.0	15.0	0.80	400		
ECWH20622□V()	0.0062	23.0	8.0	16.5	21.5	20.0	15.0	0.80			
ECWH20682□V()	0.0068	23.0	8.5	16.5	21.5	20.0	15.0	0.80			
ECWH20752□V()	0.0075	23.0	9.5	18.0	23.0	20.0	15.0	0.80			
ECWH20822□V()	0.0082	23.0	10.0	18.0	23.0	20.0	15.0	0.80	300		
ECWH20912□V()	0.0091	23.0	10.0	19.0	24.0	20.0	15.0	0.80			
ECWH20103□V()	0.010	23.0	10.5	19.5	24.5	20.0	15.0	0.80			
ECWH20113□V()	0.011	23.0	11.0	20.0	25.0	20.0	15.0	0.80			
ECWH20123□V()	0.012	23.0	11.5	20.5	25.5	20.0	15.0	0.80			
ECWH20133□V()	0.013	23.0	12.0	21.0	26.0	20.0	15.0	0.80			
ECWH20153□V()	0.015	23.0	12.0	21.5	26.5	20.0	15.0	0.80			

— Suffix for lead crimped
 — Cap. tol. code



ECWH(V) Type 1000VDC Series (Metallized Polypropylene Film)

Erectrical Characteristics <Typical Data>

Temperature Characteristics

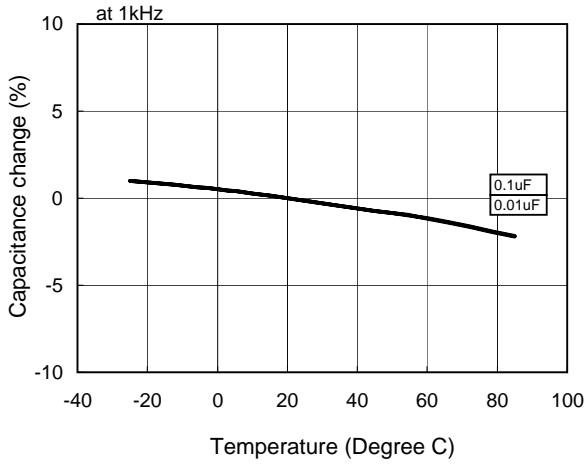

Frequency Characteristics

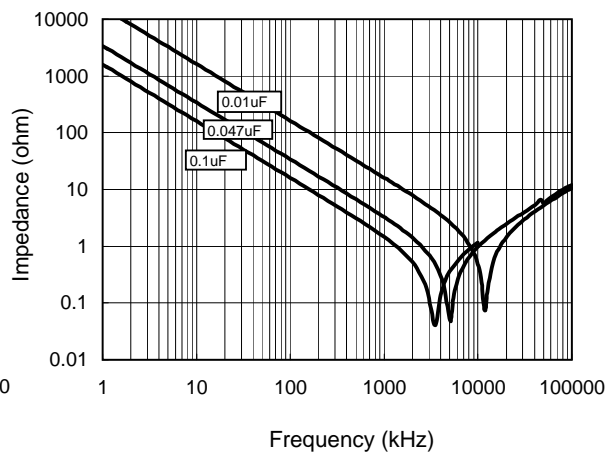
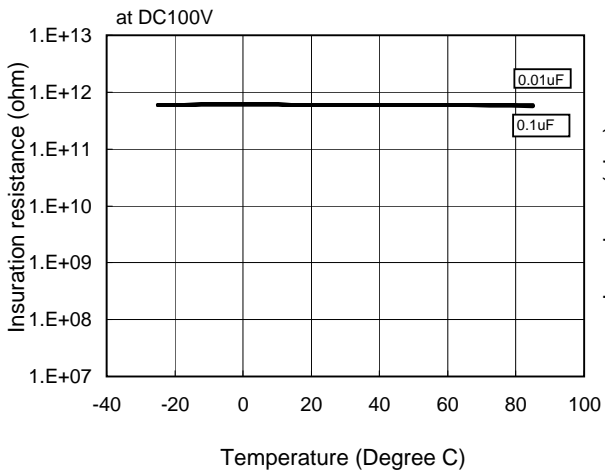
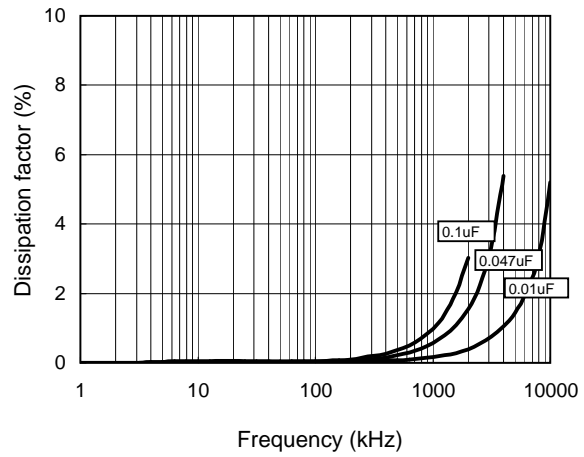
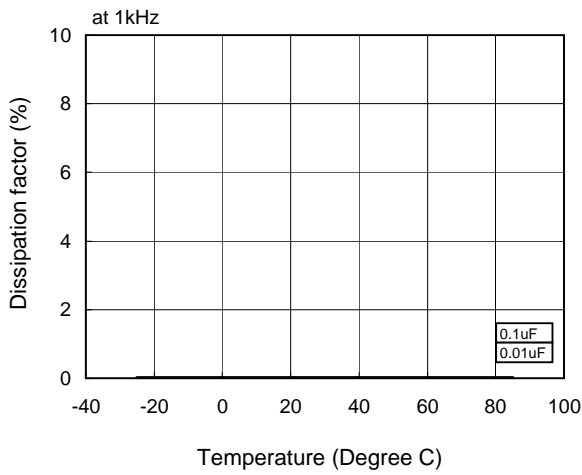
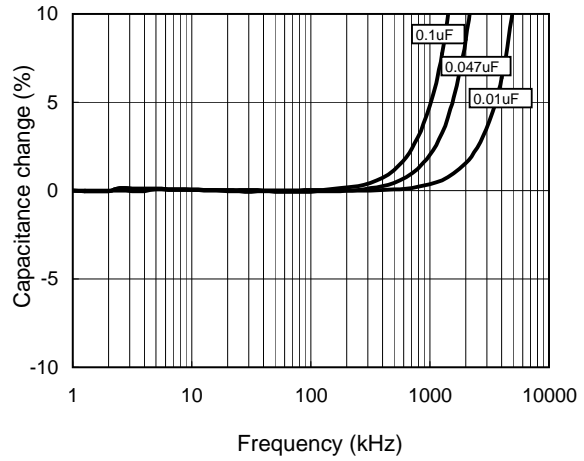



ECWH(V) Type 1000VDC Series (Metallized Polypropylene Film)

Applicable Specifications

Permissible Current

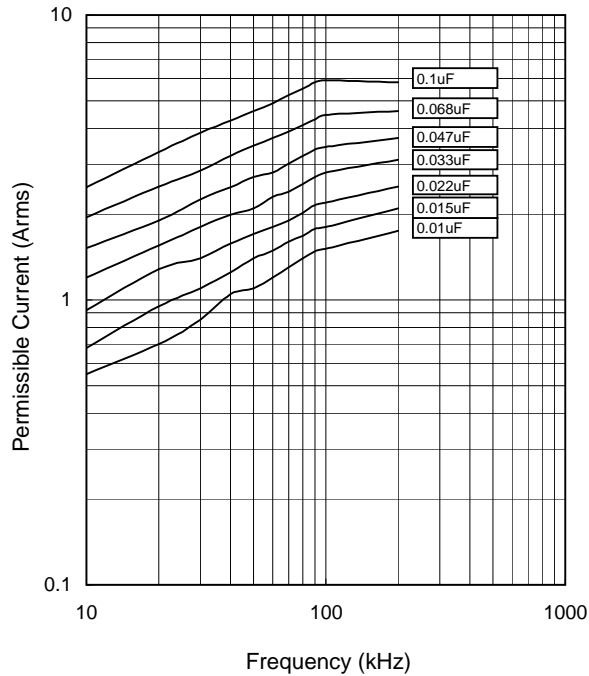

Voltage Derating by Temperature

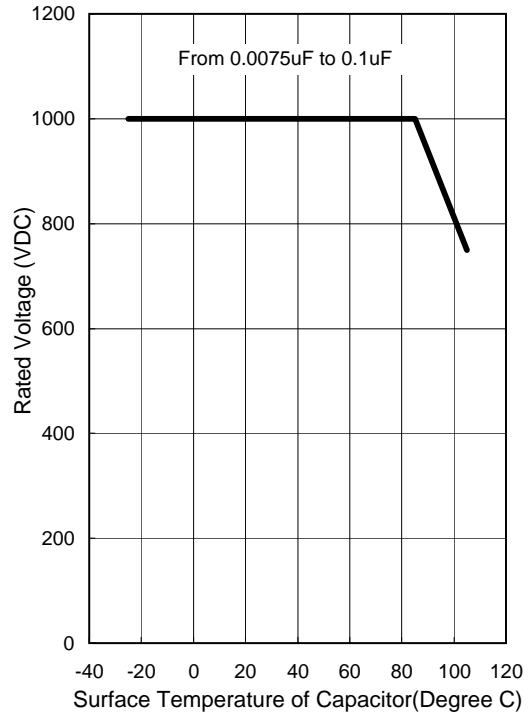

Pulse Handling Capability (dV/dt)

(Max 10000cycles)

Rating Voltage	Capacitance Value(uF)	Code	dV/dt(V/us)	Current(o-p) (A)
1000VDC	0.0100	103	6000	60.0
	0.0150	153		90.0
	0.0220	223		132.0
	0.0330	333		198.0
	0.0470	473		282.0
	0.0680	683		408.0
	0.1000	104		600.0

* Please consult Panasonic if your condition exceeds the above spec.



ECWH(V) Type 1250VDC Series (Metallized Polypropylene Film)

Electrical Characteristics <Typical Data>

Temperature Characteristics

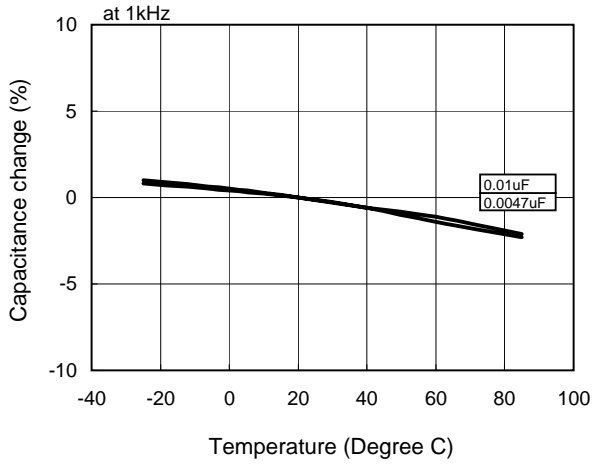

Frequency Characteristics

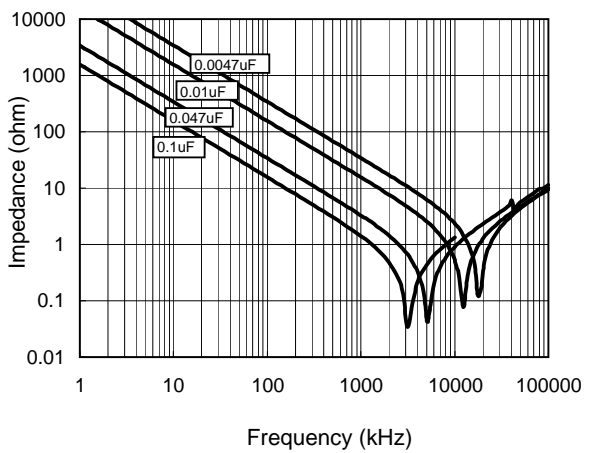
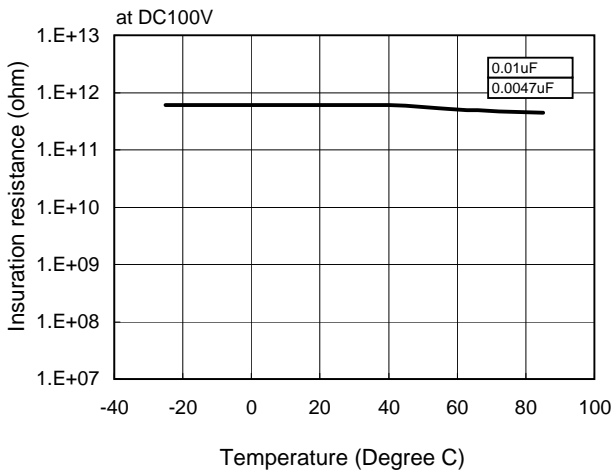
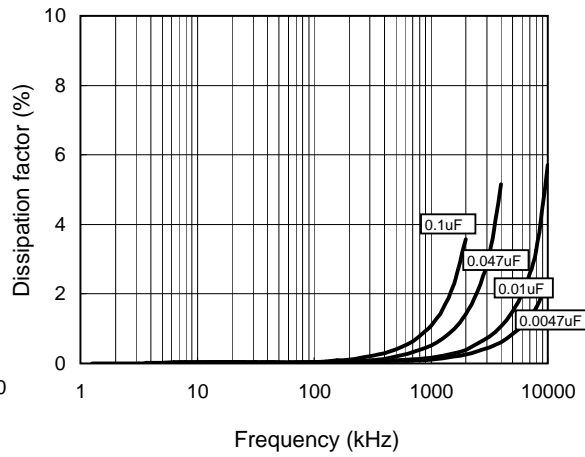
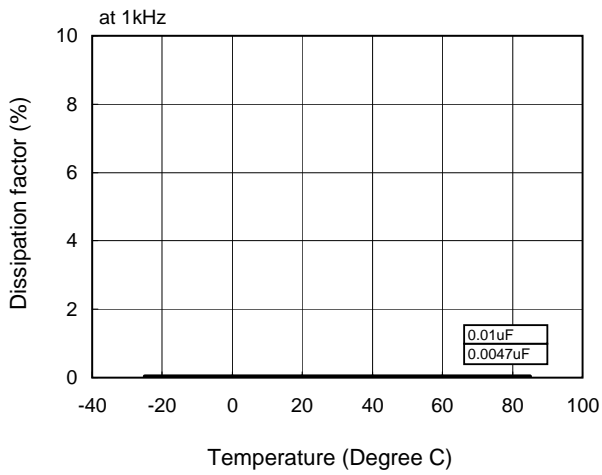
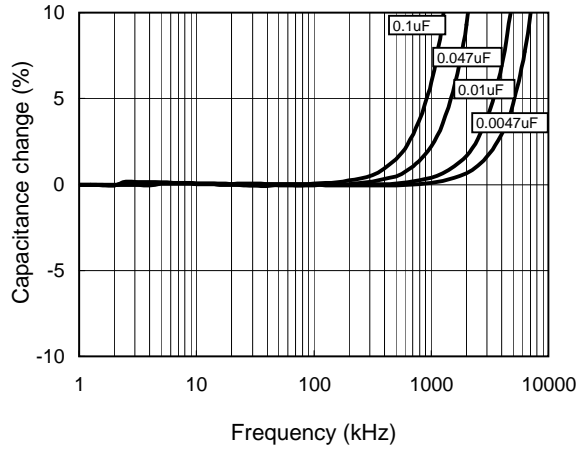



ECWH(V) Type 1250VDC Series (Metallized Polypropylene Film)

Applicable Specifications

Permissible Current

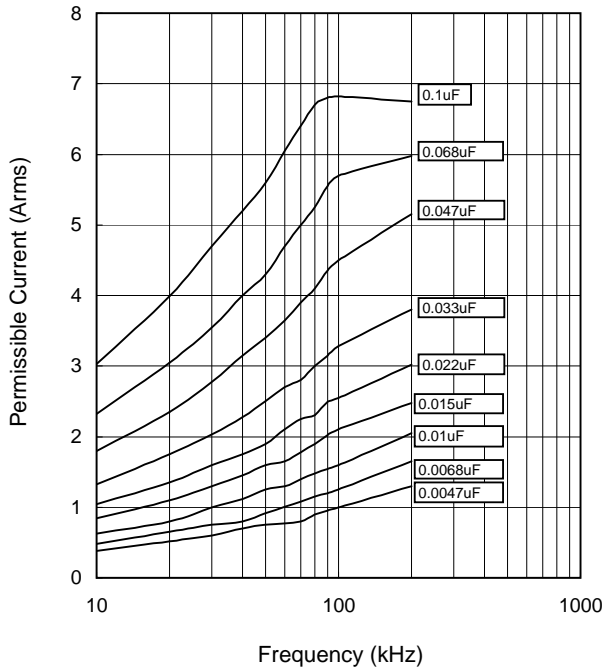

Voltage Derating by Temperature

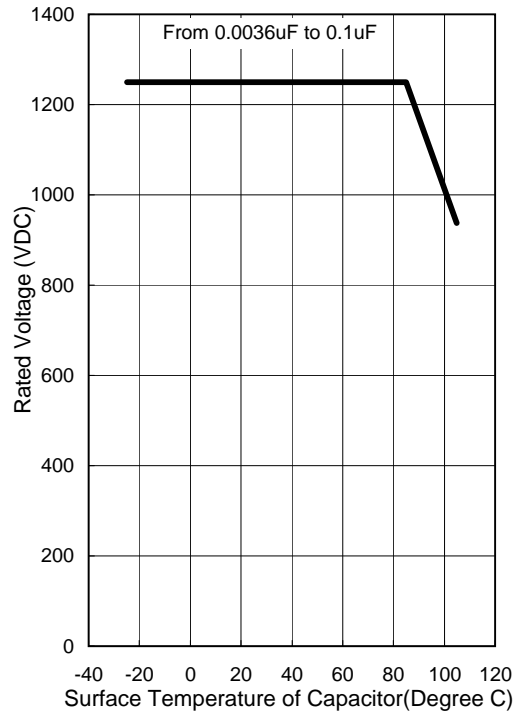

Pulse Handling Capability (dV/dt)

(Max 10000cycles)

Rating Voltage	Capacitance Value(uF)	Code	dV/dt(V/us)	Current(o-p) (A)
1250VDC	0.0047	472	6000	28.2
	0.0068	682		40.8
	0.0100	103		60.0
	0.0150	153		90.0
	0.0220	223		132.0
	0.0330	333		198.0
	0.0470	473		282.0
	0.0680	683		408.0
	0.1000	104		600.0

* Please consult Panasonic if your condition exceeds the above spec.



ECWH(V) Type 1600VDC Series (Metallized Polypropylene Film)

Electrical Characteristics <Typical Data>

Temperature Characteristics

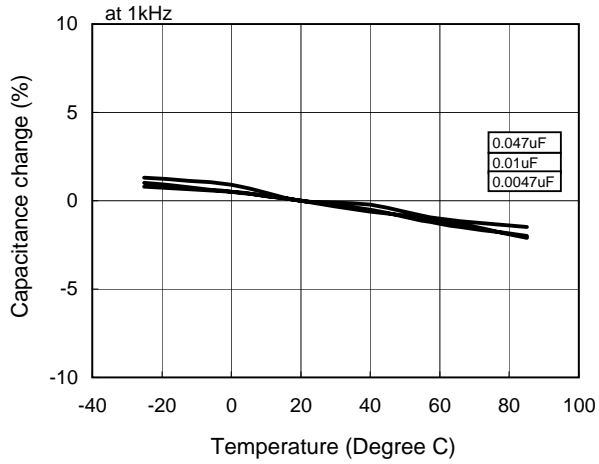

Frequency Characteristics

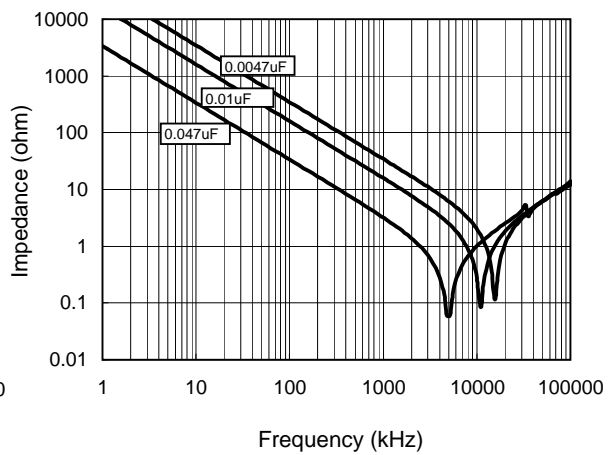
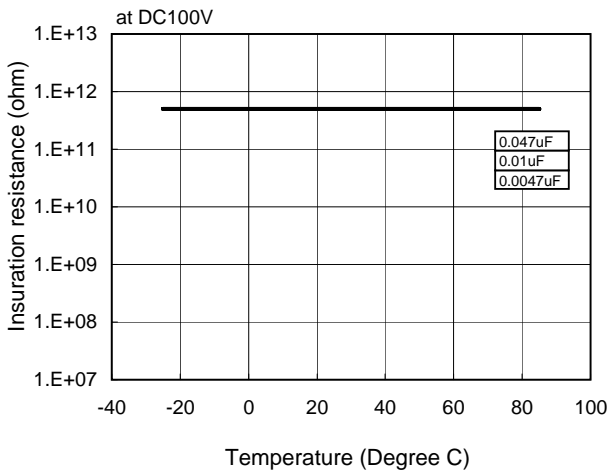
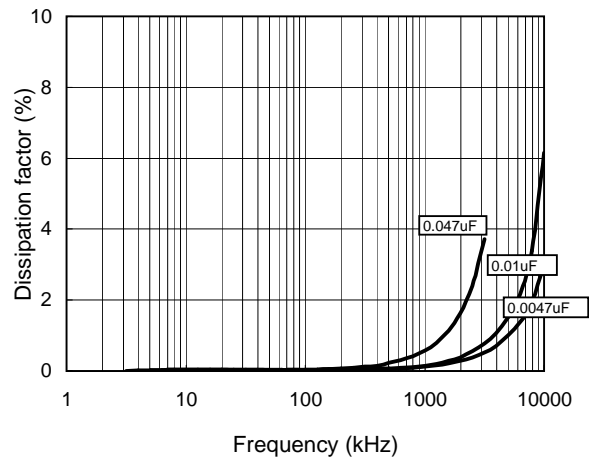
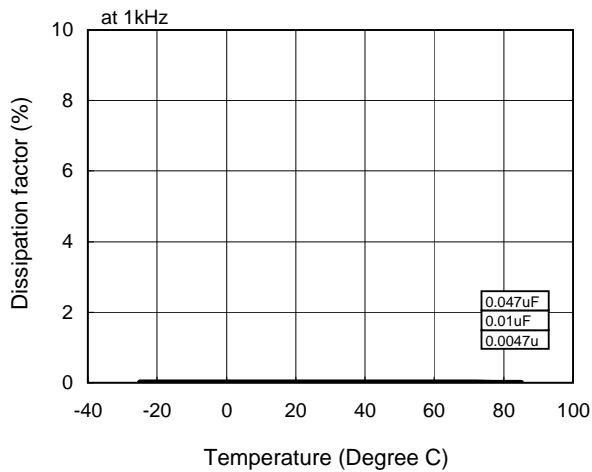
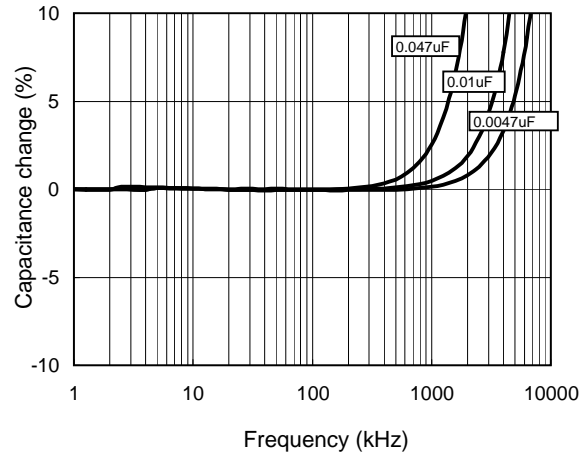



ECWH(V) Type 1600VDC Series (Metallized Polypropylene Film)

Applicable Specifications

Permissible Current

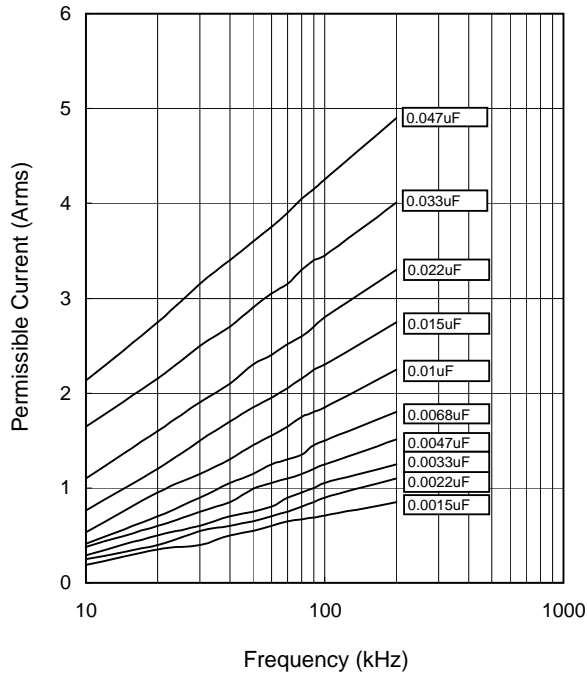

Voltage Derating by Temperature

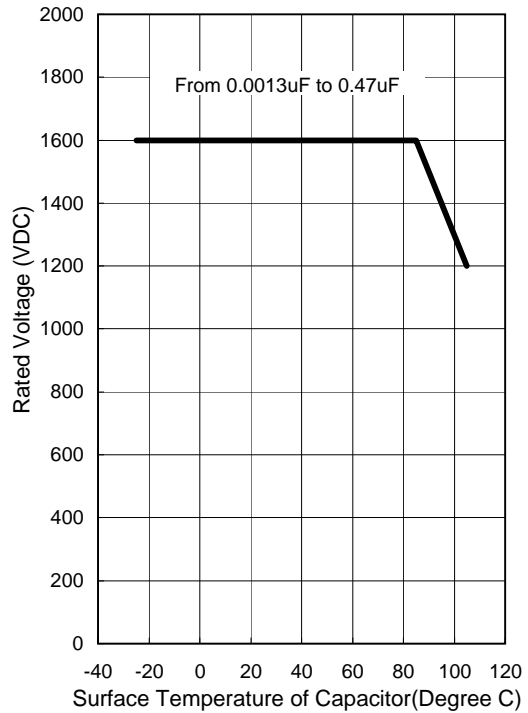

Pulse Handling Capability (dV/dt)

(Max 10000cycles)

Rating Voltage	Capacitance Value(uF)	Code	dV/dt(V/us)	Current(o-p) (A)
1600VDC	0.0015	152	6000	9.0
	0.0022	222		13.2
	0.0033	332		19.8
	0.0047	472		28.2
	0.0068	682		40.8
	0.0100	103		60.0
	0.0150	153		90.0
	0.0220	223		132.0
	0.0330	333		198.0
	0.0470	473		282.0

* Please consult Panasonic if your condition exceeds the above spec.



ECWH(V) Type 2000VDC Series (Metallized Polypropylene Film)

Erectrical Characteristics <Typical Data>

Temperature Characteristics

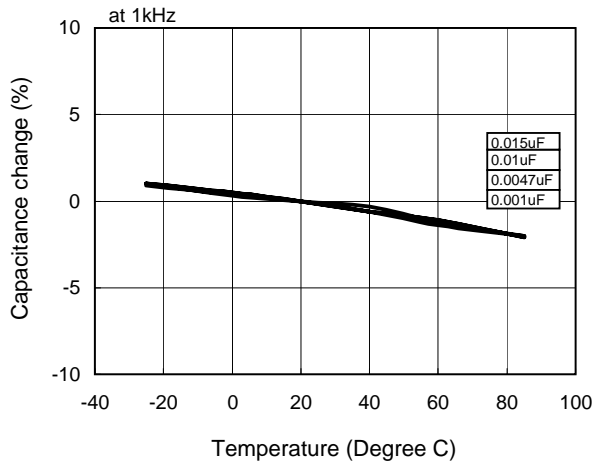

Frequency Characteristics

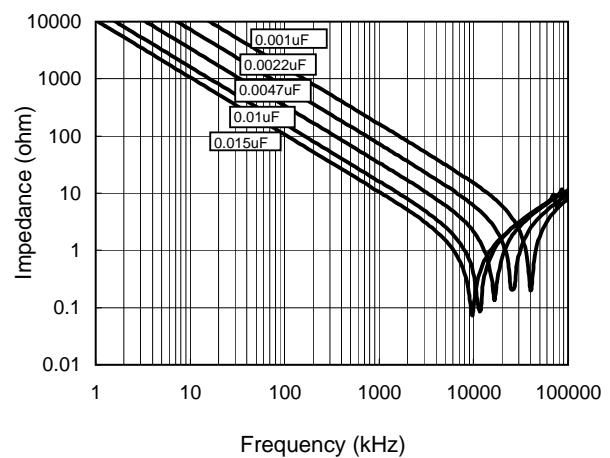
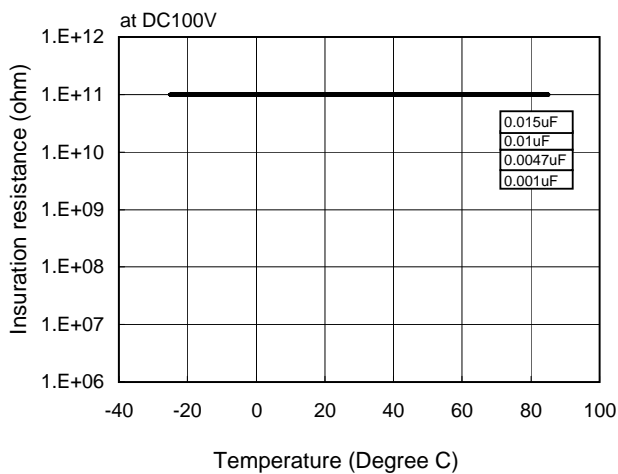
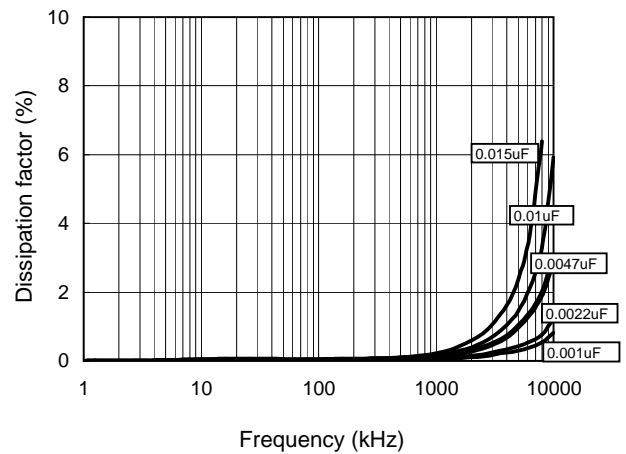
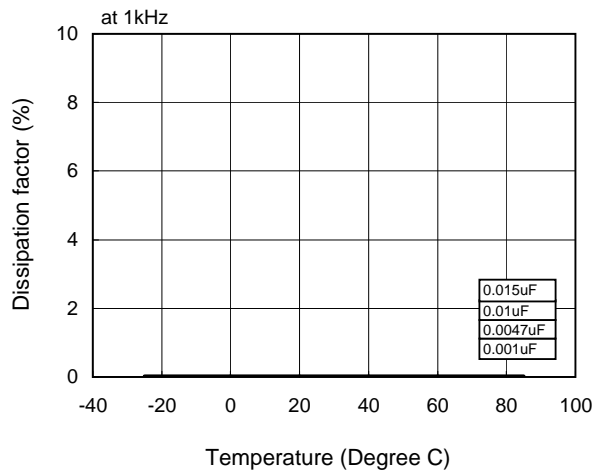
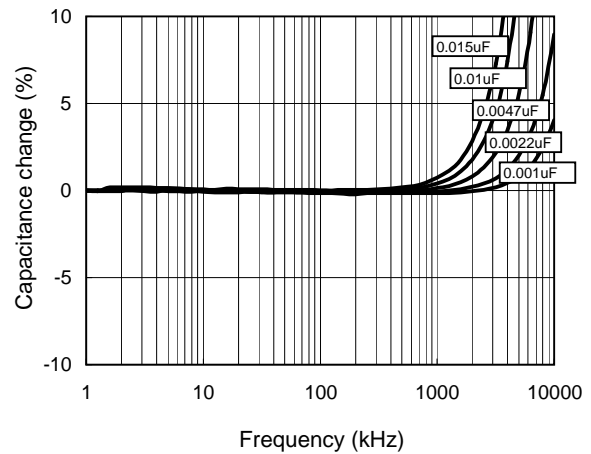



ECWH(V) Type 2000VDC Series (Metallized Polypropylene Film)

Applicable Specifications

Permissible Current

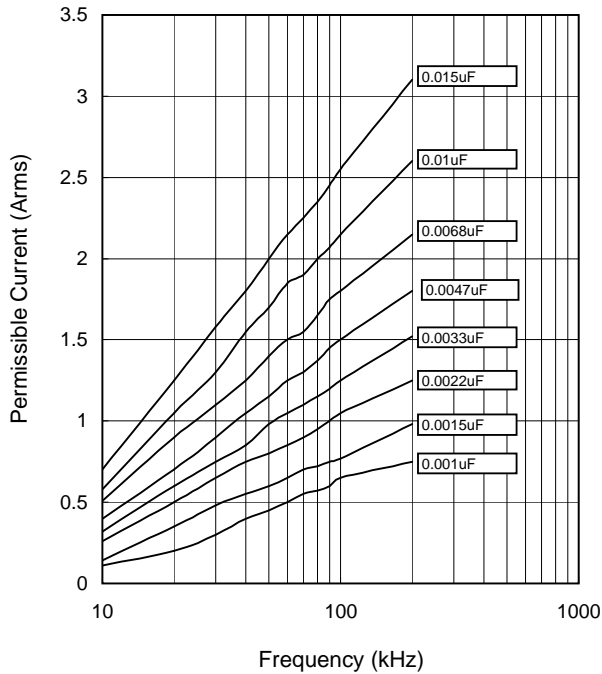

Voltage Derating by Temperature

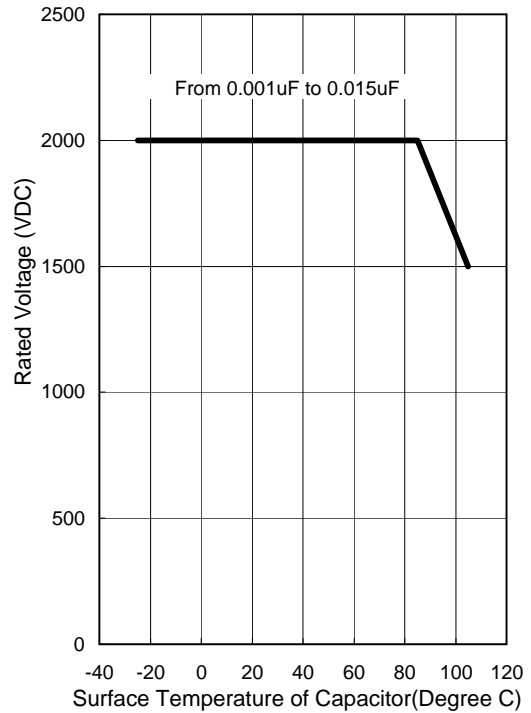

Pulse Handling Capability (dV/dt)

(Max 10000cycles)

Rating Voltage	Capacitance Value(uF)	Code	dV/dt(V/us)	Current(o-p) (A)
2000VDC	0.0010	102	6000	6.0
	0.0015	152		9.0
	0.0022	222		13.2
	0.0033	332		19.8
	0.0047	472		28.2
	0.0068	682		40.8
	0.0100	103		60.0
	0.0150	153		90.0

* Please consult Panasonic if your condition exceeds the above spec.

Mouser Electronics

Authorized Distributor

Click to View Pricing, Inventory, Delivery & Lifecycle Information:

Panasonic:

[ECW-H8102RJV](#) [ECW-H12472JV](#) [ECW-H12103JV](#) [ECW-H12473JV](#) [ECW-H16333JV](#) [ECW-H16563JV](#) [ECW-H8122HV](#) [ECW-H8822JV](#) [ECW-H10102JV](#) [ECW-H8102JV](#) [ECW-H8103JV](#) [ECW-H8392JV](#) [ECW-H8472JV](#) [ECW-H8472RJV](#) [ECW-H8682JV](#) [ECW-H10102HV](#) [ECW-H10102HVB](#) [ECW-H10102JVB](#) [ECW-H10102RHV](#) [ECW-H10102RJV](#) [ECW-H10103HV](#) [ECW-H10103HVB](#) [ECW-H10103JV](#) [ECW-H10103JVB](#) [ECW-H10103RHV](#) [ECW-H10103RJV](#) [ECW-H10104HV](#) [ECW-H10104HVB](#) [ECW-H10104JV](#) [ECW-H10104JVB](#) [ECW-H10104RHV](#) [ECW-H10104RJV](#) [ECW-H10112HV](#) [ECW-H10112HVB](#) [ECW-H10112JV](#) [ECW-H10112JVB](#) [ECW-H10112RHV](#) [ECW-H10112RJV](#) [ECW-H10113HV](#) [ECW-H10113HVB](#) [ECW-H10113JV](#) [ECW-H10113JVB](#) [ECW-H10113RHV](#) [ECW-H10113RJV](#) [ECW-H10122HV](#) [ECW-H10122HVB](#) [ECW-H10122JV](#) [ECW-H10122JVB](#) [ECW-H10122RHV](#) [ECW-H10122RJV](#) [ECW-H10123HV](#) [ECW-H10123HVB](#) [ECW-H10123JV](#) [ECW-H10123JVB](#) [ECW-H10123RHV](#) [ECW-H10123RJV](#) [ECW-H10132HV](#) [ECW-H10132HVB](#) [ECW-H10132JV](#) [ECW-H10132JVB](#) [ECW-H10132RHV](#) [ECW-H10132RJV](#) [ECW-H10133HV](#) [ECW-H10133HVB](#) [ECW-H10133JV](#) [ECW-H10133JVB](#) [ECW-H10133RHV](#) [ECW-H10133RJV](#) [ECW-H10152HV](#) [ECW-H10152HVB](#) [ECW-H10152JV](#) [ECW-H10152JVB](#) [ECW-H10152RHV](#) [ECW-H10152RJV](#) [ECW-H10153HV](#) [ECW-H10153HVB](#) [ECW-H10153JV](#) [ECW-H10153JVB](#) [ECW-H10153RHV](#) [ECW-H10153RJV](#) [ECW-H10162HV](#) [ECW-H10162HVB](#) [ECW-H10162JV](#) [ECW-H10162JVB](#) [ECW-H10162RHV](#) [ECW-H10162RJV](#) [ECW-H10163HV](#) [ECW-H10163HVB](#) [ECW-H10163JV](#) [ECW-H10163JVB](#) [ECW-H10163RHV](#) [ECW-H10163RJV](#) [ECW-H10182HV](#) [ECW-H10182HVB](#) [ECW-H10182JV](#) [ECW-H10182JVB](#) [ECW-H10182RHV](#) [ECW-H10182RJV](#) [ECW-H10183HV](#) [ECW-H10183HVB](#)