



Is Now Part of



**ON Semiconductor®**

To learn more about ON Semiconductor, please visit our website at  
[www.onsemi.com](http://www.onsemi.com)

Please note: As part of the Fairchild Semiconductor integration, some of the Fairchild orderable part numbers will need to change in order to meet ON Semiconductor's system requirements. Since the ON Semiconductor product management systems do not have the ability to manage part nomenclature that utilizes an underscore (\_), the underscore (\_) in the Fairchild part numbers will be changed to a dash (-). This document may contain device numbers with an underscore (\_). Please check the ON Semiconductor website to verify the updated device numbers. The most current and up-to-date ordering information can be found at [www.onsemi.com](http://www.onsemi.com). Please email any questions regarding the system integration to [Fairchild\\_questions@onsemi.com](mailto:Fairchild_questions@onsemi.com).

ON Semiconductor and the ON Semiconductor logo are trademarks of Semiconductor Components Industries, LLC dba ON Semiconductor or its subsidiaries in the United States and/or other countries. ON Semiconductor owns the rights to a number of patents, trademarks, copyrights, trade secrets, and other intellectual property. A listing of ON Semiconductor's product/patent coverage may be accessed at [www.onsemi.com/site/pdf/Patent-Marking.pdf](http://www.onsemi.com/site/pdf/Patent-Marking.pdf). ON Semiconductor reserves the right to make changes without further notice to any products herein. ON Semiconductor makes no warranty, representation or guarantee regarding the suitability of its products for any particular purpose, nor does ON Semiconductor assume any liability arising out of the application or use of any product or circuit, and specifically disclaims any and all liability, including without limitation special, consequential or incidental damages. Buyer is responsible for its products and applications using ON Semiconductor products, including compliance with all laws, regulations and safety requirements or standards, regardless of any support or applications information provided by ON Semiconductor. "Typical" parameters which may be provided in ON Semiconductor data sheets and/or specifications can and do vary in different applications and actual performance may vary over time. All operating parameters, including "Typicals" must be validated for each customer application by customer's technical experts. ON Semiconductor does not convey any license under its patent rights nor the rights of others. ON Semiconductor products are not designed, intended, or authorized for use as a critical component in life support systems or any FDA Class 3 medical devices or medical devices with a same or similar classification in a foreign jurisdiction or any devices intended for implantation in the human body. Should Buyer purchase or use ON Semiconductor products for any such unintended or unauthorized application, Buyer shall indemnify and hold ON Semiconductor and its officers, employees, subsidiaries, affiliates, and distributors harmless against all claims, costs, damages, and expenses, and reasonable attorney fees arising out of, directly or indirectly, any claim of personal injury or death associated with such unintended or unauthorized use, even if such claim alleges that ON Semiconductor was negligent regarding the design or manufacture of the part. ON Semiconductor is an Equal Opportunity/Affirmative Action Employer. This literature is subject to all applicable copyright laws and is not for resale in any manner.



August 2015

# FCPF650N80Z

## N-Channel SuperFET<sup>®</sup> II MOSFET

800 V, 10 A, 650 mΩ

### Features

- $R_{DS(on)} = 530 \text{ m}\Omega$  (Typ.)
- Ultra Low Gate Charge (Typ.  $Q_g = 27 \text{ nC}$ )
- Low  $E_{oss}$  (Typ.  $2.8 \text{ uJ @ 400V}$ )
- Low Effective Output Capacitance (Typ.  $C_{oss(eff.)} = 124 \text{ pF}$ )
- 100% Avalanche Tested
- RoHS Compliant
- ESD Improved Capability

### Applications

- AC - DC Power Supply
- LED Lighting

### Description

SuperFET<sup>®</sup> II MOSFET is Fairchild Semiconductor's brand-new high voltage super-junction (SJ) MOSFET family that is utilizing charge balance technology for outstanding low on-resistance and lower gate charge performance. This technology is tailored to minimize conduction loss, provide superior switching performance,  $dv/dt$  rate and higher avalanche energy. In addition, internal gate-source ESD diode allows to withstand over 2kV HBM surge stress. Consequently, SuperFET II MOSFET is very suitable for the switching power applications such as Audio, Laptop adapter, Lighting, ATX power and industrial power applications.



### Absolute Maximum Ratings $T_C = 25^\circ\text{C}$ unless otherwise noted.

Symbol	Parameter	FCPF650N80Z	Unit
$V_{DSS}$	Drain to Source Voltage	800	V
$V_{GSS}$	Gate to Source Voltage	- DC	$\pm 20$
		- AC (f > 1 Hz)	$\pm 30$
$I_D$	Drain Current	- Continuous ( $T_C = 25^\circ\text{C}$ )	10*
		- Continuous ( $T_C = 100^\circ\text{C}$ )	6.3*
$I_{DM}$	Drain Current	- Pulsed (Note 1)	24*
$E_{AS}$	Single Pulsed Avalanche Energy (Note 2)	204	mJ
$I_{AR}$	Avalanche Current (Note 1)	1.6	A
$E_{AR}$	Repetitive Avalanche Energy (Note 1)	0.305	mJ
$dv/dt$	MOSFET $dv/dt$	100	V/ns
	Peak Diode Recovery $dv/dt$ (Note 3)	20	
$P_D$	Power Dissipation ( $T_C = 25^\circ\text{C}$ )		30.5
		- Derate Above $25^\circ\text{C}$	0.24
$T_J, T_{STG}$	Operating and Storage Temperature Range	-55 to +150	$^\circ\text{C}$
$T_L$	Maximum Lead Temperature for Soldering, 1/8" from Case for 5 Seconds	300	$^\circ\text{C}$

\*Drain current limited by maximum junction temperature, with heatsink.

### Thermal Characteristics

Symbol	Parameter	FCPF650N80Z	Unit
$R_{\theta JC}$	Thermal Resistance, Junction to Case, Max.	4.1	$^\circ\text{C/W}$
$R_{\theta JA}$	Thermal Resistance, Junction to Ambient, Max.	62.5	

## Package Marking and Ordering Information

Part Number	Top Mark	Package	Packing Method	Reel Size	Tape Width	Quantity
FCPF650N80Z	FCPF650N80Z	TO-220F	Tube	N/A	N/A	50 units

## Electrical Characteristics $T_C = 25^\circ\text{C}$ unless otherwise noted.

Symbol	Parameter	Test Conditions	Min.	Typ.	Max.	Unit
--------	-----------	-----------------	------	------	------	------

### Off Characteristics

$BV_{DSS}$	Drain to Source Breakdown Voltage	$V_{GS} = 0\text{ V}, I_D = 1\text{ mA}, T_J = 25^\circ\text{C}$	800	-	-	V
$\Delta BV_{DSS} / \Delta T_J$	Breakdown Voltage Temperature Coefficient	$I_D = 1\text{ mA}$ , Referenced to $25^\circ\text{C}$	-	0.8	-	$\text{V}/^\circ\text{C}$
$I_{DSS}$	Zero Gate Voltage Drain Current	$V_{DS} = 800\text{ V}, V_{GS} = 0\text{ V}$	-	-	25	$\mu\text{A}$
		$V_{DS} = 640\text{ V}, V_{GS} = 0\text{ V}, T_C = 125^\circ\text{C}$	-	-	250	
$I_{GSS}$	Gate to Body Leakage Current	$V_{GS} = \pm 20\text{ V}, V_{DS} = 0\text{ V}$	-	-	$\pm 10$	$\mu\text{A}$

### On Characteristics

$V_{GS(th)}$	Gate Threshold Voltage	$V_{GS} = V_{DS}, I_D = 0.8\text{ mA}$	2.5	-	4.5	V
$R_{DS(on)}$	Static Drain to Source On Resistance	$V_{GS} = 10\text{ V}, I_D = 4\text{ A}$	-	530	650	$\text{m}\Omega$
$g_{FS}$	Forward Transconductance	$V_{DS} = 20\text{ V}, I_D = 4\text{ A}$	-	7.8	-	S

### Dynamic Characteristics

$C_{iss}$	Input Capacitance	$V_{DS} = 100\text{ V}, V_{GS} = 0\text{ V}, f = 1\text{ MHz}$	-	1178	1565	$\text{pF}$
$C_{oss}$	Output Capacitance		-	36	48	$\text{pF}$
$C_{rss}$	Reverse Transfer Capacitance		-	0.84	-	$\text{pF}$
$C_{oss}$	Output Capacitance	$V_{DS} = 480\text{ V}, V_{GS} = 0\text{ V}, f = 1\text{ MHz}$	-	18	-	$\text{pF}$
$C_{oss(eff.)}$	Effective Output Capacitance	$V_{DS} = 0\text{ V to } 480\text{ V}, V_{GS} = 0\text{ V}$	-	124	-	$\text{pF}$
$Q_{g(tot)}$	Total Gate Charge at 10V	$V_{DS} = 640\text{ V}, I_D = 8\text{ A}, V_{GS} = 10\text{ V}$	-	27	35	$\text{nC}$
$Q_{gs}$	Gate to Source Gate Charge	$V_{GS} = 10\text{ V}$ (Note 4)	-	6	-	$\text{nC}$
$Q_{gd}$	Gate to Drain "Miller" Charge		-	11	-	$\text{nC}$
ESR	Equivalent Series Resistance	$f = 1\text{ MHz}$	-	1.9	-	$\Omega$

### Switching Characteristics

$t_{d(on)}$	Turn-On Delay Time	$V_{DD} = 400\text{ V}, I_D = 8\text{ A}, V_{GS} = 10\text{ V}, R_G = 4.7\ \Omega$ (Note 4)	-	17	44	ns
$t_r$	Turn-On Rise Time		-	11	32	ns
$t_{d(off)}$	Turn-Off Delay Time		-	40	90	ns
$t_f$	Turn-Off Fall Time		-	3.4	17	ns

### Drain-Source Diode Characteristics

$I_S$	Maximum Continuous Drain to Source Diode Forward Current	-	-	10	A	
$I_{SM}$	Maximum Pulsed Drain to Source Diode Forward Current	-	-	24	A	
$V_{SD}$	Drain to Source Diode Forward Voltage	$V_{GS} = 0\text{ V}, I_{SD} = 8\text{ A}$	-	-	1.2	V
$t_{rr}$	Reverse Recovery Time	$V_{GS} = 0\text{ V}, I_{SD} = 8\text{ A}, di_F/dt = 100\text{ A}/\mu\text{s}$	-	365	-	ns
$Q_{rr}$	Reverse Recovery Charge		-	5.9	-	$\mu\text{C}$

#### Notes:

1. Repetitive rating: pulse width limited by maximum junction temperature.
2.  $I_{AS} = 1.6\text{ A}, R_G = 25\ \Omega$ , Starting  $T_J = 25^\circ\text{C}$
3.  $I_{SD} \leq 10\text{ A}, di/dt \leq 200\text{ A}/\mu\text{s}, V_{DD} \leq BV_{DSS}$ , Starting  $T_J = 25^\circ\text{C}$
4. Essentially independent of operating temperature typical characteristics.

## Typical Performance Characteristics

**Figure 1. On-Region Characteristics**

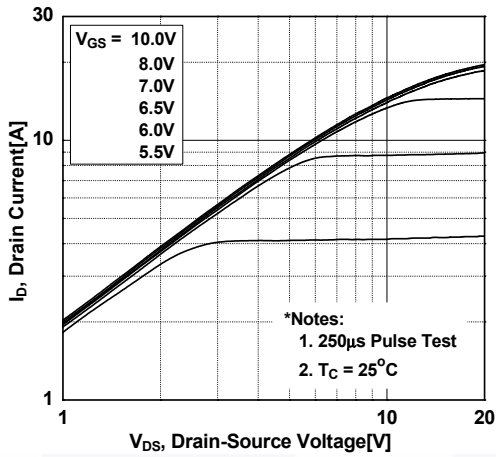

**Figure 2. Transfer Characteristics**

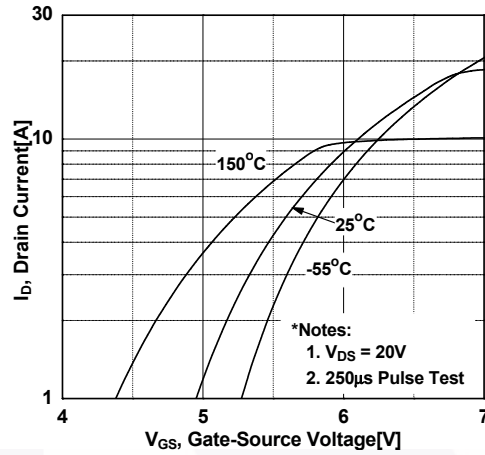

**Figure 3. On-Resistance Variation vs. Drain Current and Gate Voltage**

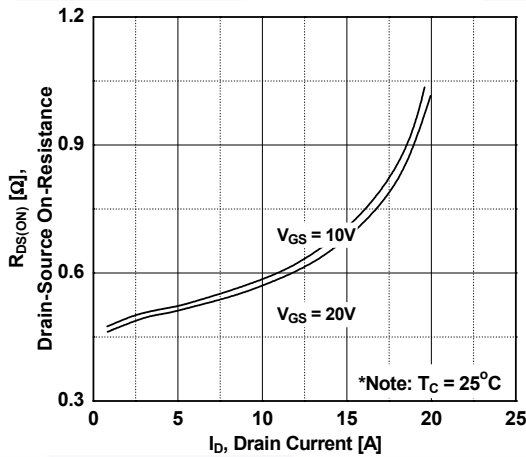

**Figure 4. Body Diode Forward Voltage Variation vs. Source Current and Temperature**

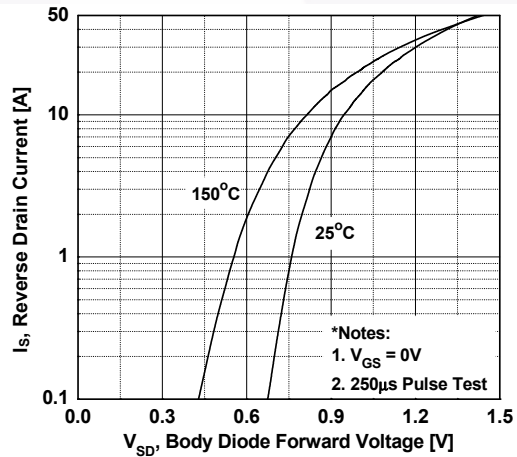

**Figure 5. Capacitance Characteristics**

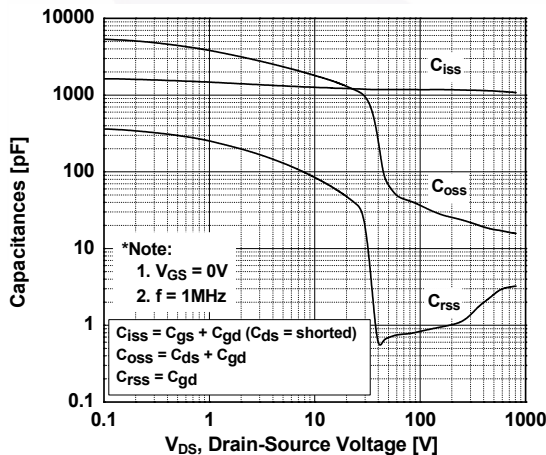

**Figure 6. Gate Charge Characteristics**

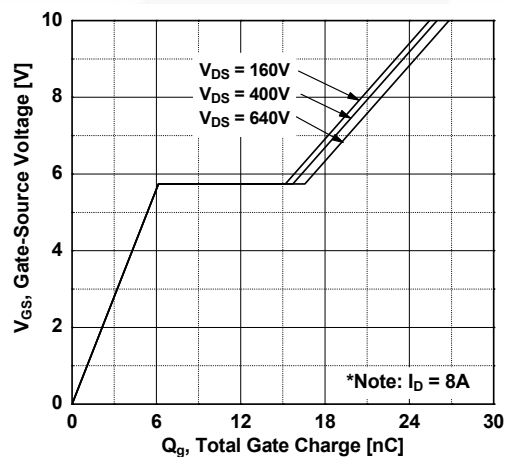

Typical Performance Characteristics (Continued)

Figure 7. Breakdown Voltage Variation vs. Temperature

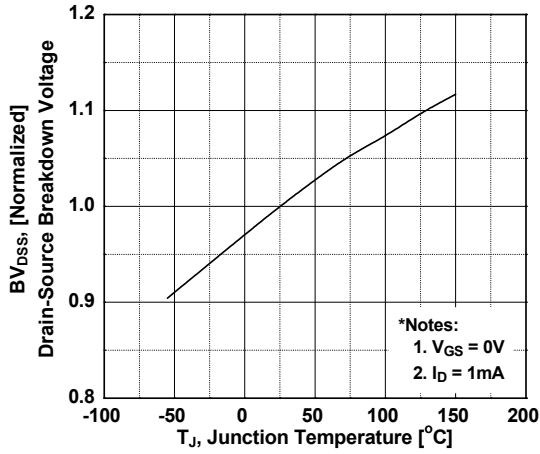

Figure 8. On-Resistance Variation vs. Temperature

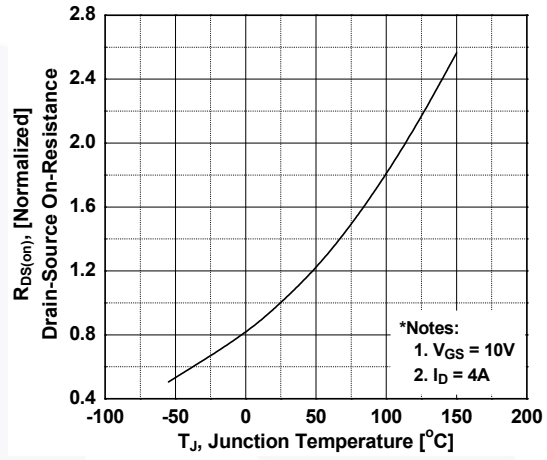

Figure 9. Maximum Safe Operating Area

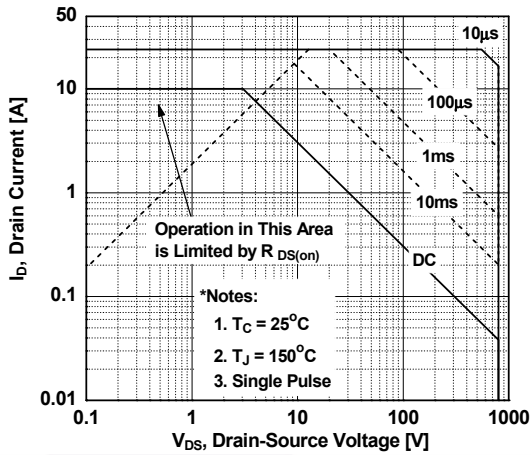

Figure 10. Maximum Drain Current vs. Case Temperature

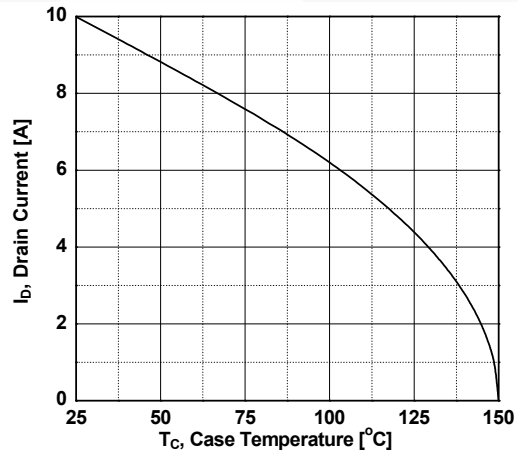
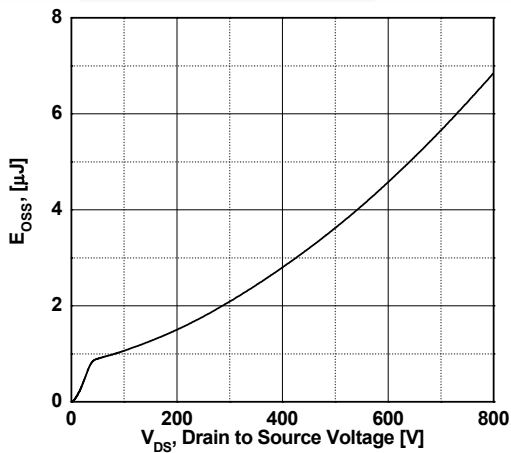
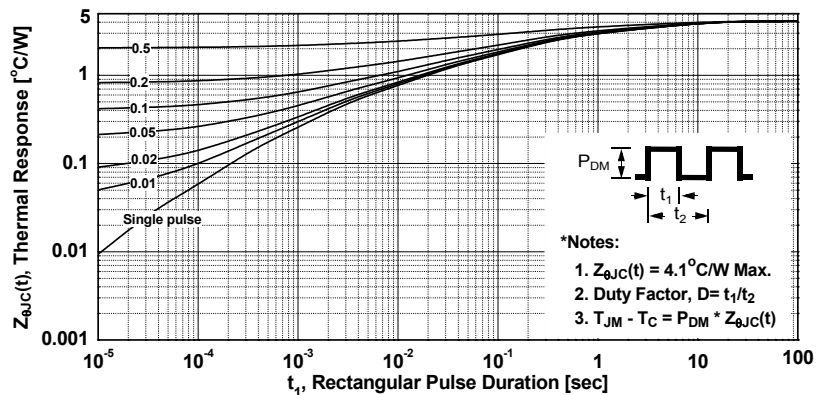

Figure 11. E\_oss vs. Drain to Source Voltage



Typical Performance Characteristics (Continued)

Figure 12. Transient Thermal Response Curve



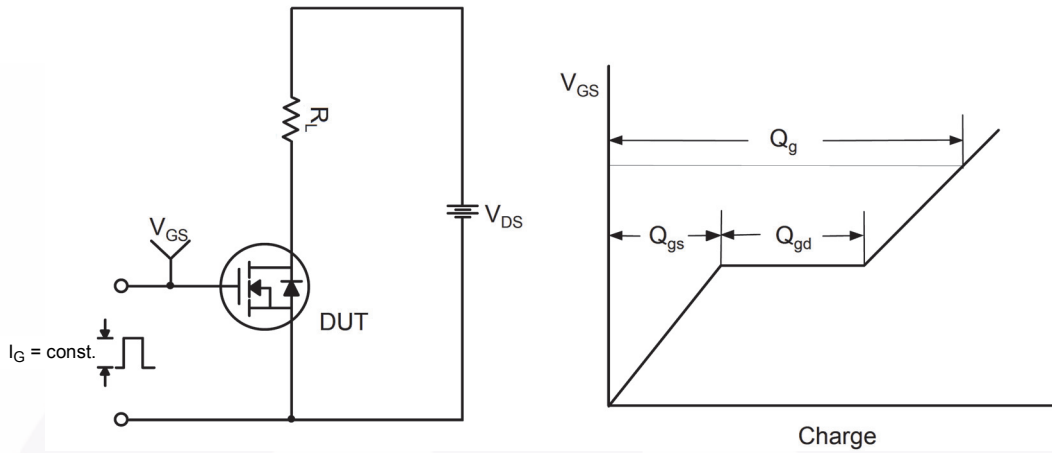

Figure 13. Gate Charge Test Circuit & Waveform



Figure 14. Resistive Switching Test Circuit & Waveforms

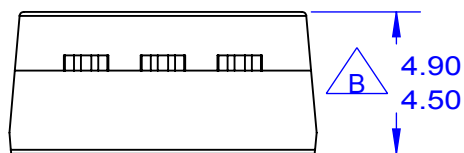
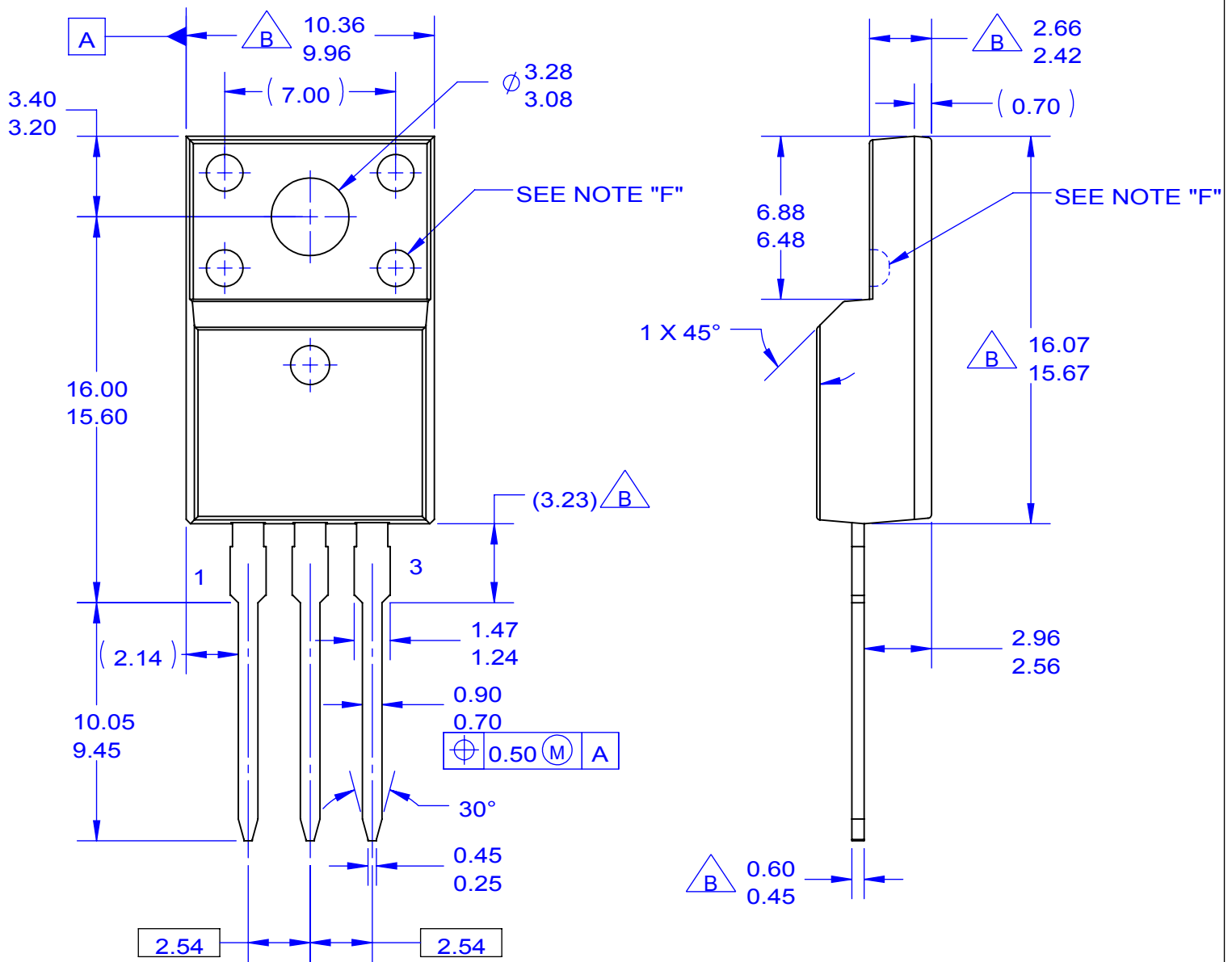

Figure 15. Unclamped Inductive Switching Test Circuit & Waveforms



Figure 16. Peak Diode Recovery  $dv/dt$  Test Circuit & Waveforms





ON Semiconductor



NOTES:

- A. EXCEPT WHERE NOTED CONFORMS TO EIAJ SC91A.
- B. DOES NOT COMPLY EIAJ STD. VALUE.
- C. ALL DIMENSIONS ARE IN MILLIMETERS.
- D. DIMENSIONS ARE EXCLUSIVE OF BURRS, MOLD FLASH AND TIE BAR PROTRUSIONS.
- E. DIMENSION AND TOLERANCE AS PER ASME Y14.5-1994.
- F. OPTION 1 - WITH SUPPORT PIN HOLE.  
OPTION 2 - NO SUPPORT PIN HOLE.
- G. DRAWING FILE NAME: TO220M03REV5

ON Semiconductor and  are trademarks of Semiconductor Components Industries, LLC dba ON Semiconductor or its subsidiaries in the United States and/or other countries. ON Semiconductor owns the rights to a number of patents, trademarks, copyrights, trade secrets, and other intellectual property. A listing of ON Semiconductor's product/patent coverage may be accessed at [www.onsemi.com/site/pdf/Patent-Marking.pdf](http://www.onsemi.com/site/pdf/Patent-Marking.pdf). ON Semiconductor reserves the right to make changes without further notice to any products herein. ON Semiconductor makes no warranty, representation or guarantee regarding the suitability of its products for any particular purpose, nor does ON Semiconductor assume any liability arising out of the application or use of any product or circuit, and specifically disclaims any and all liability, including without limitation special, consequential or incidental damages. Buyer is responsible for its products and applications using ON Semiconductor products, including compliance with all laws, regulations and safety requirements or standards, regardless of any support or applications information provided by ON Semiconductor. "Typical" parameters which may be provided in ON Semiconductor data sheets and/or specifications can and do vary in different applications and actual performance may vary over time. All operating parameters, including "Typicals" must be validated for each customer application by customer's technical experts. ON Semiconductor does not convey any license under its patent rights nor the rights of others. ON Semiconductor products are not designed, intended, or authorized for use as a critical component in life support systems or any FDA Class 3 medical devices or medical devices with a same or similar classification in a foreign jurisdiction or any devices intended for implantation in the human body. Should Buyer purchase or use ON Semiconductor products for any such unintended or unauthorized application, Buyer shall indemnify and hold ON Semiconductor and its officers, employees, subsidiaries, affiliates, and distributors harmless against all claims, costs, damages, and expenses, and reasonable attorney fees arising out of, directly or indirectly, any claim of personal injury or death associated with such unintended or unauthorized use, even if such claim alleges that ON Semiconductor was negligent regarding the design or manufacture of the part. ON Semiconductor is an Equal Opportunity/Affirmative Action Employer. This literature is subject to all applicable copyright laws and is not for resale in any manner.

## PUBLICATION ORDERING INFORMATION

### LITERATURE FULFILLMENT:

Literature Distribution Center for ON Semiconductor  
19521 E. 32nd Pkwy, Aurora, Colorado 80011 USA  
**Phone:** 303-675-2175 or 800-344-3860 Toll Free USA/Canada  
**Fax:** 303-675-2176 or 800-344-3867 Toll Free USA/Canada  
**Email:** [orderlit@onsemi.com](mailto:orderlit@onsemi.com)

**N. American Technical Support:** 800-282-9855 Toll Free  
USA/Canada  
**Europe, Middle East and Africa Technical Support:**  
Phone: 421 33 790 2910  
**Japan Customer Focus Center**  
Phone: 81-3-5817-1050

**ON Semiconductor Website:** [www.onsemi.com](http://www.onsemi.com)  
**Order Literature:** <http://www.onsemi.com/orderlit>  
For additional information, please contact your local  
Sales Representative

# Mouser Electronics

Authorized Distributor

Click to View Pricing, Inventory, Delivery & Lifecycle Information:

[ON Semiconductor:](#)

[FCPF650N80Z](#)