

Segmented Photodiodes (SPOT Series)

Position Sensing Detector (PSD)

The **SPOT** Series are common substrate photodetectors segmented into either two (2) or four (4) separate active areas. They are available with either a 0.005" or 0.0004" well defined gap between the adjacent elements resulting in high response uniformity between the elements. The SPOT series are ideal for very accurate nulling or centering applications. Position information can be obtained when the light spot diameter is larger than the spacing between the cells.

Spectral response range is from 350-1100nm. Notch or bandpass filters can be added to achieve specific spectral responses.

These detectors exhibit excellent stability over time and temperature, fast response times necessary for high speed or pulse operation, and position resolutions of better than 0.1 μm . Maximum recommended power density is 10 mW / cm^2 and typical uniformity of response for a 1 mm diameter spot is $\pm 2\%$.

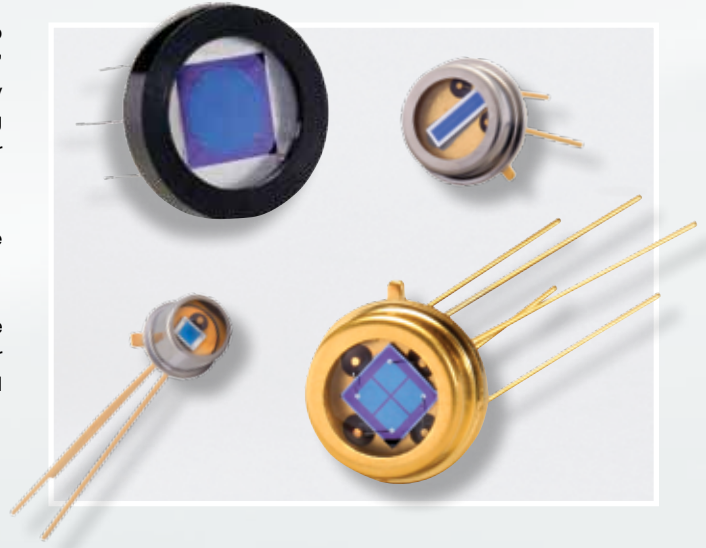

The circuit on the opposite page represents a typical biasing and detection circuit set up for both bi-cells and quad-cells. For position calculations and further details, refer to "Photodiode Characteristics" section of the catalog.

APPLICATIONS

- Machine Tool Alignment
- Position Measuring
- Beam Centering
- Surface Profiling
- Targeting
- Guidance Systems

FEATURES

- High Accuracy
- Excellent Resolution
- High-Speed Response
- Ultra Low Dark Current
- Excellent Response Match
- High Stability over Time and Temperature

Typical Cross-Over Characteristics

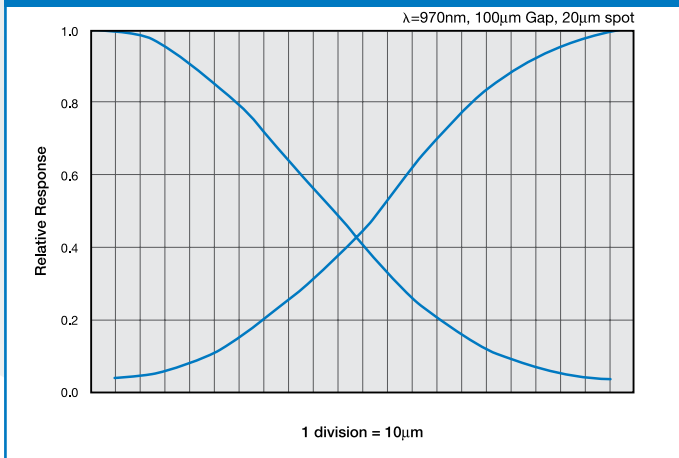

Typical Spectral Response

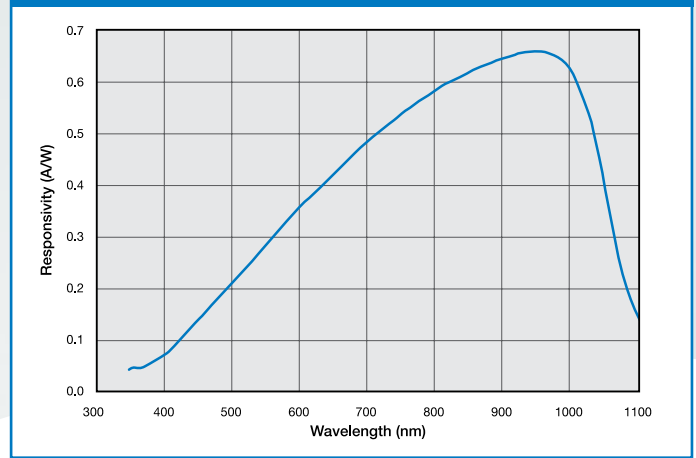

Typical Capacitance vs. Reverse Bias Voltage

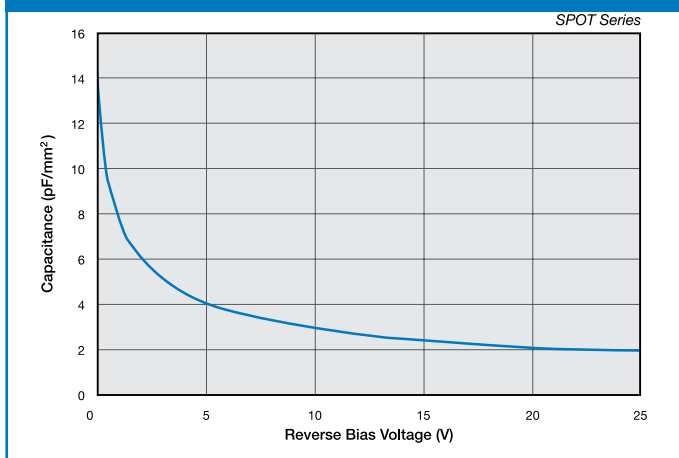

Typical Dark Current vs. Reverse Bias

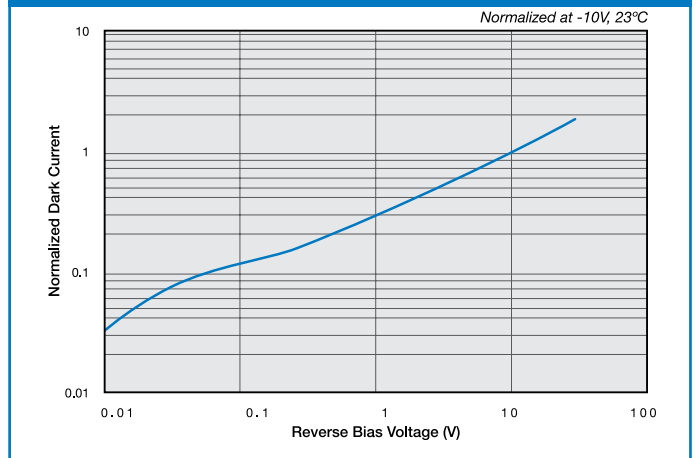

Segmented Photodiodes (SPOT Series)

Typical Electro-Optical Specifications at $T_A=23^\circ\text{C}$

Model Number	Active Area Per Element		Element Gap (mm)	Responsivity (A/W)		Capacitance (pF)	Dark Current (nA)		NEP (W/√Hz)	Reverse Voltage (V)	Rise Time (ns)	Temp Range (°C)		Package Style ¶
	Area (mm ²)	Dimensions (mm)		970 nm		-10 V	-10 V		-10 V 970 nm		-10 V 780 nm 50 Ω	Operating	Storage	
				min.	typ.	typ.	typ.	max.	typ.		max.			
Two-Element Series, Metal Package														
CD-25T	2.3	4.6 x 0.5	0.020	0.60	0.65	50@ -15V	20@ -15V		1.1 e-14	30	18	-40 ~ +100	-55 ~ +125	2 / TO-5
SPOT-2D	3.3	1.3 x 2.5	0.127			11	0.15	2.0			22			41 / TO-5
SPOT-2DMI	0.7	0.6 x 1.2	0.013			3	0.05	1.0			11			40 / TO-18
SPOT-3D	2.8	0.6 x 4.6	0.025			7	0.13	2.0			25			41 / TO-5
Four Element Series, Metal Package														
SPOT-4D	1.61	1.3 sq	0.127	0.60	0.65	5	0.10	1.0	8.7 e-15	30	22	-40 ~ +100	-55 ~ +125	41 / TO-5
SPOT-4DMI	0.25	0.5 sq	0.013			1	0.01	0.5	2.8 e-15		9			
SPOT-9D	19.6	10 φ ‡	0.102			60	0.50	10.0	1.9 e-14		33			43 / LoProf
SPOT-9DMI	19.6		0.010								28			

‡ Overall Diameter (All four Quads)

¶ For mechanical drawings please refer to pages 61 thru 73.

Chip centering within $\pm 0.010''$.

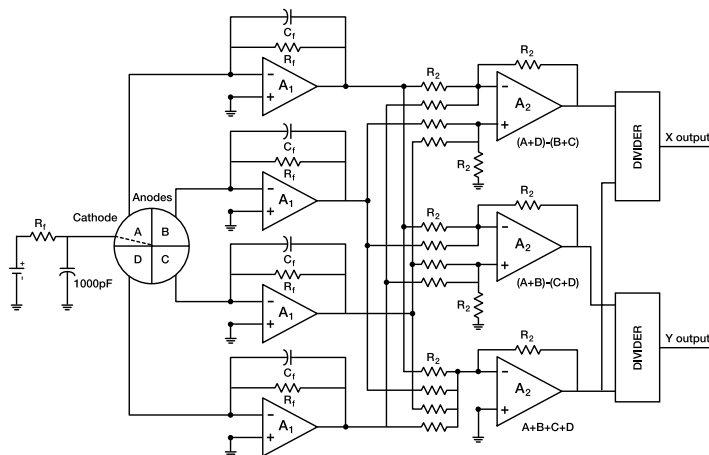

AVOID DIRECT LIGHT

Since the spectral response of silicon photodiode includes the visible light region, care must be taken to avoid photodiode exposure to high ambient light levels, particularly from tungsten sources or sunlight. During shipment from OSI Optoelectronics, your photodiodes are packaged in opaque, padded containers to avoid ambient light exposure and damage due to shock from dropping or jarring.

AVOID SHARP PHYSICAL SHOCK

Photodiodes can be rendered inoperable if dropped or sharply jarred. The wire bonds are delicate and can become separated from the photodiode's bonding pads when the detector is dropped or otherwise receives a sharp physical blow.

CLEAN WINDOWS WITH OPTICAL GRADE CLOTH / TISSUE

Most windows on OSI Optoelectronics photodiodes are either silicon or quartz. They should be cleaned with isopropyl alcohol and a soft (optical grade) pad.

OBSERVE STORAGE TEMPERATURES AND HUMIDITY LEVELS

Photodiode exposure to extreme high or low storage temperatures can affect the subsequent performance of a silicon photodiode. Storage temperature guidelines are presented in the photodiode performance specifications of this catalog. Please maintain a non-condensing environment for optimum performance and lifetime.

OBSERVE ELECTROSTATIC DISCHARGE (ESD) PRECAUTIONS

OSI Optoelectronics photodiodes, especially with IC devices (e.g. Photops) are considered ESD sensitive. The photodiodes are shipped in ESD protective packaging. When unpacking and using these products, anti-ESD precautions should be observed.

DO NOT EXPOSE PHOTODIODES TO HARSH CHEMICALS

Photodiode packages and/or operation may be impaired if exposed to CHLOROTHENE, THINNER, ACETONE, or TRICHLOROETHYLENE.

INSTALL WITH CARE

Most photodiodes in this catalog are provided with wire or pin leads for installation in circuit boards or sockets. Observe the soldering temperatures and conditions specified below:

Soldering Iron:	Soldering 30 W or less Temperature at tip of iron 300°C or lower.
Dip Soldering:	Bath Temperature: 260±5°C. Immersion Time: within 5 Sec. Soldering Time: within 3 Sec.
Vapor Phase Soldering:	DO NOT USE
Reflow Soldering:	DO NOT USE

Photodiodes in plastic packages should be given special care. Clear plastic packages are more sensitive to environmental stress than those of black plastic. Storing devices in high humidity can present problems when soldering. Since the rapid heating during soldering stresses the wire bonds and can cause wire to bonding pad separation, it is recommended that devices in plastic packages to be baked for 24 hours at 85°C.

The leads on the photodiode **SHOULD NOT BE FORMED**. If your application requires lead spacing modification, please contact OSI Optoelectronics Applications group at (310)978-0516 before forming a product's leads. Product warranties could be voided.



*Most of our standard catalog products are RoHS Compliant. Please contact us for details

Mechanical Drawings

Mechanical Specifications and Die Topography

1. Parameter Definitions:

A = Distance from top of chip to top of glass.

a = Photodiode Anode.

B = Distance from top of glass to bottom of case.

c = Photodiode Cathode

(Note: cathode is common to case in metal package products unless otherwise noted).

W = Window Diameter.

F.O.V. = Filed of View (see definition below).

2. Dimensions are in inches (1 inch = 25.4 mm).

3. Pin diameters are 0.018 ± 0.002 " unless otherwise specified.

4. Tolerances (unless otherwise noted)

General: $0.XX \pm 0.01$ "

$0.XXX \pm 0.005$ "

Chip Centering: ± 0.010 "

Dimension 'A': ± 0.015 "

5. Windows

All '**UV**' Enhanced products are provided with QUARTZ glass windows, 0.027 ± 0.002 " thick.

All '**XUV**' products are provided with removable windows.

All '**DLS**' PSD products are provided with A/R coated glass windows.

All '**FIL**' photoconductive and photovoltaic products are epoxy filled instead of glass windows.



$$F.O.V. = \tan^{-1} \left(\frac{W}{2A} \right)$$

For Further Assistance
Please Call One of Our Experienced
Sales and Applications Engineers

310-978-0516

OSI Optoelectronics
An OSI Systems Company

- Or -

visit our website at

www.osioptoelectronics.com

Mechanical Specifications

All units in inches. Pinouts are bottom view.

1 TO-18	2 TO-5	3 TO-8																																	
<p>Products: PIN-020A PIN-040A PIN-040-DP/SB</p> <p>Pin Circle Dia.=0.100</p> <table border="1"> <thead> <tr> <th>P/N</th> <th>A</th> <th>B</th> <th>W</th> </tr> </thead> <tbody> <tr> <td>PIN-020A</td> <td>0.075</td> <td>0.200</td> <td>0.155</td> </tr> <tr> <td>PIN-040A</td> <td>0.075</td> <td>0.200</td> <td>0.155</td> </tr> </tbody> </table>	P/N	A	B	W	PIN-020A	0.075	0.200	0.155	PIN-040A	0.075	0.200	0.155	<p>Products: PIN-5DI PIN-5DPI PIN-13DI PIN-13DPI PIN-5-YAG CD-25T</p> <p>Pin Circle Dia.=0.200</p> <table border="1"> <thead> <tr> <th>P/N</th> <th>A</th> <th>B</th> <th>W</th> </tr> </thead> <tbody> <tr> <td>All Others</td> <td>0.094</td> <td>0.180</td> <td>0.240</td> </tr> <tr> <td>CD-25T</td> <td>0.050</td> <td>0.130</td> <td>0.23</td> </tr> </tbody> </table>	P/N	A	B	W	All Others	0.094	0.180	0.240	CD-25T	0.050	0.130	0.23	<p>Products: PIN-6DI PIN-6DPI PIN-44DI PIN-44DPI APD50-8-150-TO8</p> <p>Pin Circle Dia.=0.295</p> <table border="1"> <thead> <tr> <th>P/N</th> <th>A</th> </tr> </thead> <tbody> <tr> <td>PIN-6DI/6DPI APD50-8-150-TO8</td> <td>0.115</td> </tr> <tr> <td>PIN-44DI/44DPI</td> <td>0.125</td> </tr> <tr> <td>OSD35-0</td> <td>0.130</td> </tr> </tbody> </table>	P/N	A	PIN-6DI/6DPI APD50-8-150-TO8	0.115	PIN-44DI/44DPI	0.125	OSD35-0	0.130	
P/N	A	B	W																																
PIN-020A	0.075	0.200	0.155																																
PIN-040A	0.075	0.200	0.155																																
P/N	A	B	W																																
All Others	0.094	0.180	0.240																																
CD-25T	0.050	0.130	0.23																																
P/N	A																																		
PIN-6DI/6DPI APD50-8-150-TO8	0.115																																		
PIN-44DI/44DPI	0.125																																		
OSD35-0	0.130																																		
<p>Products: PIN-2DI PIN-2DPI PIN-3CDI PIN-3CDP PIN-3CDPI</p> <p>Pin Circle Dia.=0.100</p> <table border="1"> <thead> <tr> <th>A</th> <th>B</th> </tr> </thead> <tbody> <tr> <td>0.070</td> <td>0.200</td> </tr> <tr> <td>0.090</td> <td>0.150</td> </tr> </tbody> </table>	A	B	0.070	0.200	0.090	0.150	<p>Products: PIN-5D PIN-5DP PIN-5DP/SB PIN-13D PIN-13DP PIN-005E-550F UV-001 UV-005 UV-005DQ UV-005EQ UV-013DQ UV-013EQ UV-015 OSD-5-0 OSD15-0 OSD5-5T OSD15-5T</p> <p>Pin Circle Dia.=0.200</p> <table border="1"> <thead> <tr> <th>P/N</th> <th>A</th> <th>B</th> </tr> </thead> <tbody> <tr> <td>OSD-Prefix Devices</td> <td>0.050</td> <td>0.130</td> </tr> <tr> <td>UV-XXXDQ</td> <td>0.065</td> <td>0.138</td> </tr> <tr> <td>UV-XXXEQ</td> <td>0.055</td> <td>0.138</td> </tr> <tr> <td>All Others</td> <td>0.102</td> <td>0.180</td> </tr> </tbody> </table> <p>Quartz Window: OSD5.8-7Q UV Transmissive Window: OSD5.8-7U</p>	P/N	A	B	OSD-Prefix Devices	0.050	0.130	UV-XXXDQ	0.065	0.138	UV-XXXEQ	0.055	0.138	All Others	0.102	0.180	<p>Products: PIN-6D PIN-6DP PIN-44D PIN-44DP UV-020 UV-035DQ UV-035EQ UV-035 Dimensions</p> <p>Pin Circle Dia.=0.295</p> <table border="1"> <thead> <tr> <th>P/N</th> <th>A</th> <th>B</th> </tr> </thead> <tbody> <tr> <td>UV-035DQ</td> <td>0.130</td> <td>0.195</td> </tr> <tr> <td>UV-035EQ</td> <td>0.120</td> <td>0.195</td> </tr> <tr> <td>All Others</td> <td>0.140</td> <td>0.205</td> </tr> </tbody> </table>	P/N	A	B	UV-035DQ	0.130	0.195	UV-035EQ	0.120	0.195	All Others	0.140	0.205
A	B																																		
0.070	0.200																																		
0.090	0.150																																		
P/N	A	B																																	
OSD-Prefix Devices	0.050	0.130																																	
UV-XXXDQ	0.065	0.138																																	
UV-XXXEQ	0.055	0.138																																	
All Others	0.102	0.180																																	
P/N	A	B																																	
UV-035DQ	0.130	0.195																																	
UV-035EQ	0.120	0.195																																	
All Others	0.140	0.205																																	
<p>Products: PIN-3CD PIN-3CDP BPX-65 OSD1-0 OSD1-5T OSD3-5T OSD1-E OSD3-E</p> <p>Pin Circle Dia.=0.100</p> <table border="1"> <thead> <tr> <th>P/N</th> <th>A</th> <th>B</th> </tr> </thead> <tbody> <tr> <td>PIN-3CD / 3CDP</td> <td>0.087</td> <td>0.146</td> </tr> <tr> <td>BPX-65</td> <td>0.075</td> <td>0.200</td> </tr> <tr> <td>OSD-Prefix Devices</td> <td>0.080</td> <td>0.200</td> </tr> </tbody> </table> <p>Quartz Window: OSD1.2-7Q UV Transmissive Window: OSD1.2-7U</p>	P/N	A	B	PIN-3CD / 3CDP	0.087	0.146	BPX-65	0.075	0.200	OSD-Prefix Devices	0.080	0.200	<p>Products: PIN-125DPL</p> <p>Pin Circle Dia.=0.100</p>	<p>Products: PIN-HR005 PIN-HR008 PIN-HR020 PIN-HR026 PIN-HR040</p> <p>Pin Circle Dia.=0.100</p>																					
P/N	A	B																																	
PIN-3CD / 3CDP	0.087	0.146																																	
BPX-65	0.075	0.200																																	
OSD-Prefix Devices	0.080	0.200																																	

Mechanical Specifications

All units in inches. Pinouts are bottom view.

40 TO-18

Products:

SPOT-2DMI

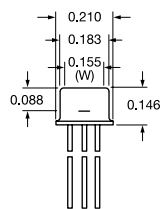

Pin Circle Dia.=0.100

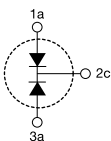

41 TO-5

Products:

SC-4D
SL3-1
SPOT-2D
SPOT-3D
SPOT-4D
SPOT-4DMI
QD7-0

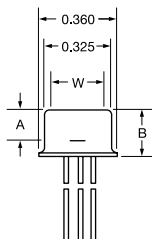

Pin Circle Dia.=0.200

Dimensions

P/N	A	B	W
SC-4D	0.071	0.142	0.240
SL3-1	0.106	0.195	0.217
SPOT-2D	0.063	0.114	0.240
SPOT-3D	0.104	0.138	0.240
SPOT-4D	0.063	0.142	0.240
SPOT-4DMI	0.063	0.142	0.240
SPOT-4DUV	0.063	0.142	0.240
QD7-0	0.050	0.130	0.230

Pinouts

P/N	1	2	3	4	5
SC-4D	c	c	c	c	a
SL3-1	a	c	a	--	--
SPOT-2D	a	c	a	--	--
SPOT-3D	a	c	a	--	--
SPOT-4D	a	a	a	a	c
SPOT-4DMI	a	a	a	a	c
SPOT-4DUV	a	a	a	a	c
QD7-0	a	a	a	a	c

42 TO-8

Products:

SL5-1

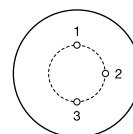
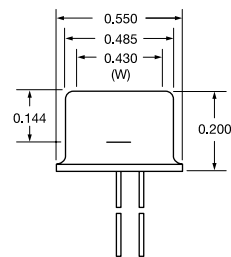

Pin Circle Dia.=0.300

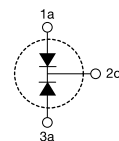

43 Low Profile

Products:

SPOT-9D
SPOT-9DMI

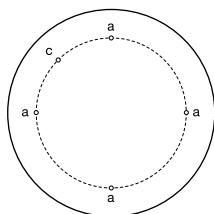
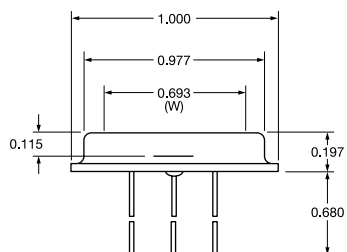

Pin Circle Dia.=0.730

44 Special

Products:

SC-10D

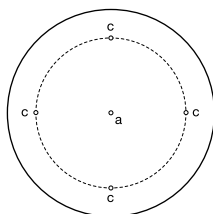
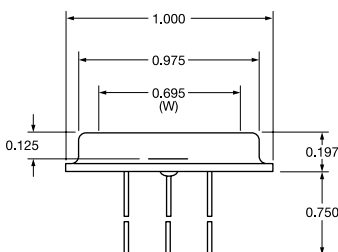

Pin Circle Dia.=0.730

45 Special

Products:

SC-25D

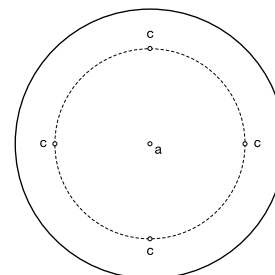
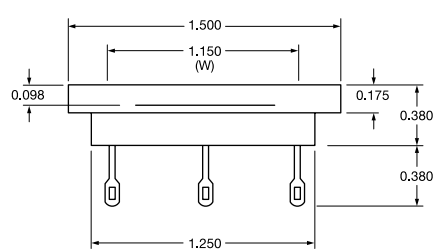

Pin Circle Dia.=0.950