



Is Now Part of



ON Semiconductor®

To learn more about ON Semiconductor, please visit our website at
www.onsemi.com

Please note: As part of the Fairchild Semiconductor integration, some of the Fairchild orderable part numbers will need to change in order to meet ON Semiconductor's system requirements. Since the ON Semiconductor product management systems do not have the ability to manage part nomenclature that utilizes an underscore (_), the underscore (_) in the Fairchild part numbers will be changed to a dash (-). This document may contain device numbers with an underscore (_). Please check the ON Semiconductor website to verify the updated device numbers. The most current and up-to-date ordering information can be found at www.onsemi.com. Please email any questions regarding the system integration to Fairchild_questions@onsemi.com.

ON Semiconductor and the ON Semiconductor logo are trademarks of Semiconductor Components Industries, LLC dba ON Semiconductor or its subsidiaries in the United States and/or other countries. ON Semiconductor owns the rights to a number of patents, trademarks, copyrights, trade secrets, and other intellectual property. A listing of ON Semiconductor's product/patent coverage may be accessed at www.onsemi.com/site/pdf/Patent-Marking.pdf. ON Semiconductor reserves the right to make changes without further notice to any products herein. ON Semiconductor makes no warranty, representation or guarantee regarding the suitability of its products for any particular purpose, nor does ON Semiconductor assume any liability arising out of the application or use of any product or circuit, and specifically disclaims any and all liability, including without limitation special, consequential or incidental damages. Buyer is responsible for its products and applications using ON Semiconductor products, including compliance with all laws, regulations and safety requirements or standards, regardless of any support or applications information provided by ON Semiconductor. "Typical" parameters which may be provided in ON Semiconductor data sheets and/or specifications can and do vary in different applications and actual performance may vary over time. All operating parameters, including "Typicals" must be validated for each customer application by customer's technical experts. ON Semiconductor does not convey any license under its patent rights nor the rights of others. ON Semiconductor products are not designed, intended, or authorized for use as a critical component in life support systems or any FDA Class 3 medical devices or medical devices with a same or similar classification in a foreign jurisdiction or any devices intended for implantation in the human body. Should Buyer purchase or use ON Semiconductor products for any such unintended or unauthorized application, Buyer shall indemnify and hold ON Semiconductor and its officers, employees, subsidiaries, affiliates, and distributors harmless against all claims, costs, damages, and expenses, and reasonable attorney fees arising out of, directly or indirectly, any claim of personal injury or death associated with such unintended or unauthorized use, even if such claim alleges that ON Semiconductor was negligent regarding the design or manufacture of the part. ON Semiconductor is an Equal Opportunity/Affirmative Action Employer. This literature is subject to all applicable copyright laws and is not for resale in any manner.



January 2016

US2AA - US2MA

Super Fast Surface Mount Rectifiers

Features

- Glass Passivated Chip Junction
 - High Surge Capacity
 - Low Forward Voltage Drop
 - Fast Switching with Reverse Recovery Time: 50~75 ns Maximum
 - UL Flammability 94V-0 Classification
 - MSL 1 per J-STD-020
 - RoHS Compliant / Green Molding Compound
 - Industrial Device Qualified per AEC-Q101 Standards
- * See authorized use policy

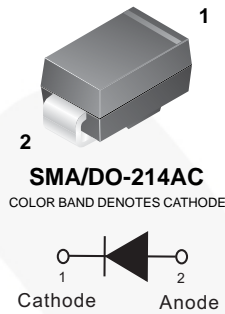

Ordering Information

Part Number	Top Mark	Package	Packing Method
US2AA	US2AA	DO-214AC (SMA)	Tape and Reel
US2BA	US2BA	DO-214AC (SMA)	Tape and Reel
US2DA	US2DA	DO-214AC (SMA)	Tape and Reel
US2FA	US2FA	DO-214AC (SMA)	Tape and Reel
US2GA	US2GA	DO-214AC (SMA)	Tape and Reel
US2JA	US2JA	DO-214AC (SMA)	Tape and Reel
US2KA	US2KA	DO-214AC (SMA)	Tape and Reel
US2MA	US2MA	DO-214AC (SMA)	Tape and Reel

US2AA - US2MA — Super Fast Surface Mount Rectifiers

Absolute Maximum Ratings

Stresses exceeding the absolute maximum ratings may damage the device. The device may not function or be operable above the recommended operating conditions and stressing the parts to these levels is not recommended. In addition, extended exposure to stresses above the recommended operating conditions may affect device reliability. The absolute maximum ratings are stress ratings only. Values are at $T_A = 25^\circ\text{C}$ unless otherwise noted.

Symbol	Parameter	Value								Unit
		US2 AA	US2 BA	US2 DA	US2 FA	US2 GA	US2 JA	US2 KA	US2 MA	
V_{RRM}	Repetitive Peak Reverse Voltage	50	100	200	300	400	600	800	1000	V
V_{RMS}	RMS Reverse Voltage	35	70	140	210	280	420	560	700	V
V_{DC}	DC Blocking Voltage	50	100	200	300	400	600	800	1000	V
$I_{F(AV)}$	Average Forward Rectified Current	1.5								A
I_{FSM}	Peak Forward Surge Current, 8.3 ms Single Half-Sine Wave, Superimposed on Rated Load	50								A
T_J	Operating Junction Temperature Range	-55 to +150								$^\circ\text{C}$
T_{STG}	Storage Temperature Range	-55 to +150								$^\circ\text{C}$

Thermal Characteristics⁽¹⁾

Values are at $T_A = 25^\circ\text{C}$ unless otherwise noted.

Symbol	Parameter	Value	Unit
$R_{\theta JA}$	Typical Thermal Resistance, Junction-to-Ambient	189	$^\circ\text{C}/\text{W}$
Ψ_{JL}	Typical Thermal Characteristics, Junction-to-Lead (with Reference to Cathode Pin)	31	$^\circ\text{C}/\text{W}$

Note:

1. Device mounted at minimum pad.

Electrical Characteristics

Values are at $T_A = 25^\circ\text{C}$ unless otherwise noted.

Symbol	Parameter	Value								Unit
		US2 AA	US2 BA	US2 DA	US2 FA	US2 GA	US2 JA	US2 KA	US2 MA	
V_F	Maximum Instantaneous Forward Voltage ⁽²⁾ at $I_F = 1.5\text{ A}$	1.0			1.3	1.7			V	
I_R	Maximum Reverse Current at Rated V_R	$T_J = 25^\circ\text{C}$		5						μA
		$T_J = 125^\circ\text{C}$		100						
T_{rr}	Maximum Reverse Recovery Time ⁽³⁾	50				75				ns
C_J	Typical Junction Capacitance ⁽⁴⁾	50				30				pF

Notes:

2. Pulse test with $PW = 300\ \mu\text{s}$, 1% duty cycle
3. Reverse recovery test conditions: $I_F = 0.5\text{ A}$, $I_R = 1.0\text{ A}$, $I_{RR} = 0.25\text{ A}$
4. Measured at 1 MHz and applied reverse voltage of 4.0 V D.C.

Typical Performance Characteristics

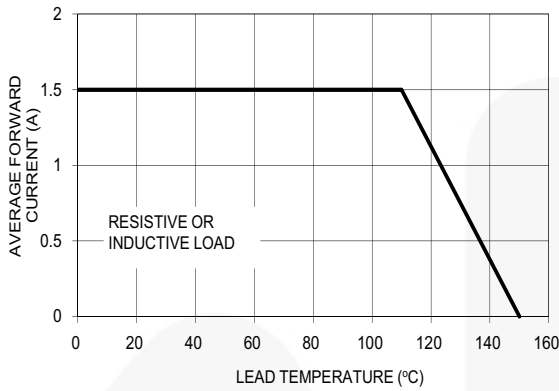

Figure 1. Forward Current Derating Curve

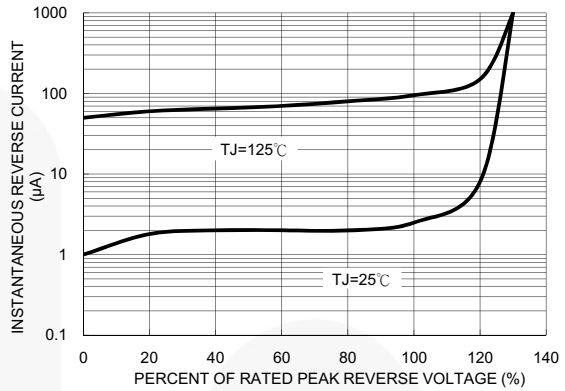

Figure 2. Typical Reverse Characteristics

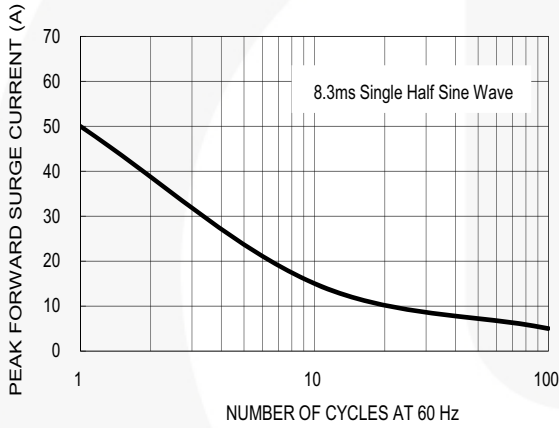

Figure 3. Maximum Non-Repetitive Forward Surge Current

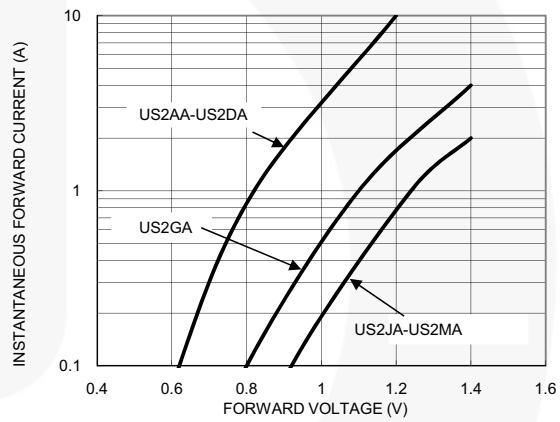

Figure 4. Typical Forward Characteristics

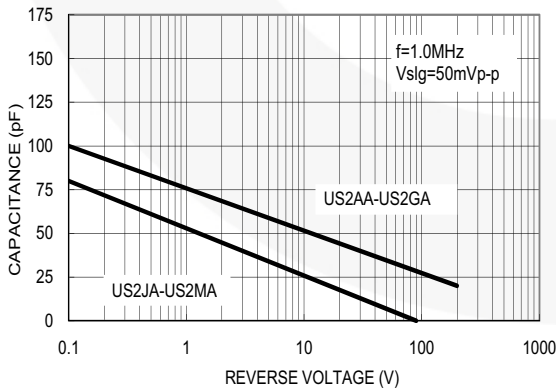

Figure 5. Typical Junction Capacitance

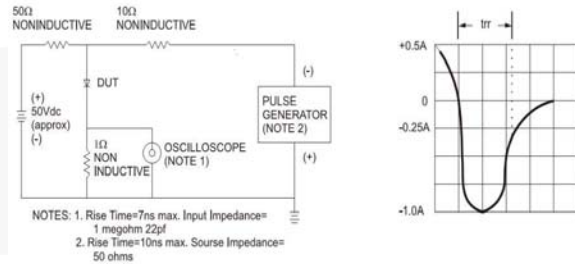
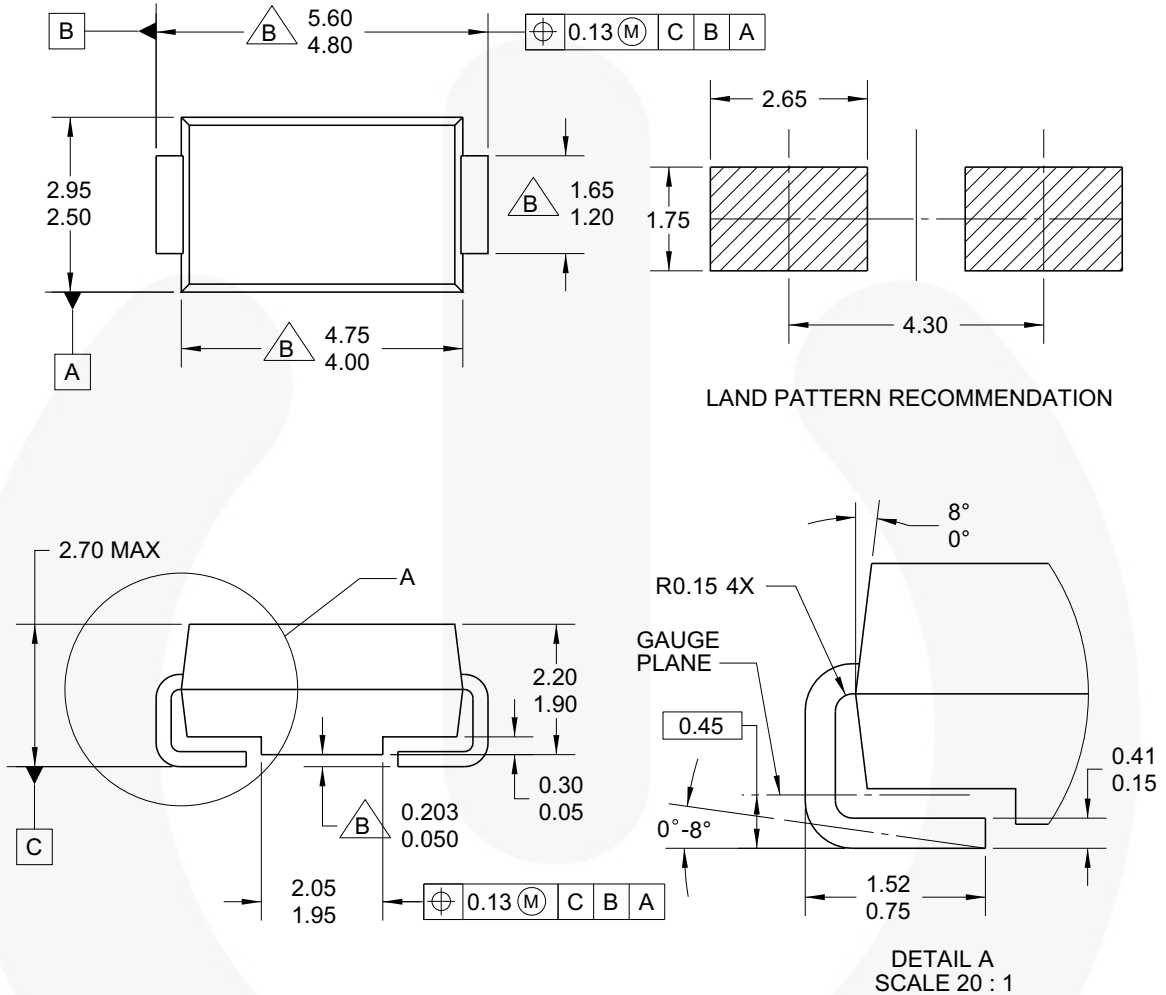

Figure 6. Reverse Recovery Time Characteristic and Test Circuit Diagram

Physical Dimensions



NOTES:





- A. EXCEPT WHERE NOTED CONFORMS TO JEDEC DO214 VARIATION AC.
- B** DOES NOT COMPLY JEDEC STD. VALUE.
- C. ALL DIMENSIONS ARE IN MILLIMETERS.
- D. DIMENSIONS ARE EXCLUSIVE OF BURRS, MOLD FLASH AND TIE BAR PROTRUSIONS.
- E. DIMENSION AND TOLERANCE AS PER ASME Y14.5-1994.
- F. LAND PATTERN STD. DIOM5025X231M.
- G. DRAWING FILE NAME: DO214ACREV1

Figure 7. 2-Lead, SMA, JEDEC DO-214, VARIATION AC



TRADEMARKS

The following includes registered and unregistered trademarks and service marks, owned by Fairchild Semiconductor and/or its global subsidiaries, and is not intended to be an exhaustive list of all such trademarks.

- | | | | |
|--|--|---|---|
| AccuPower™ | F-PFS™ | OPTOPLANAR® |  SYSTEM GENERAL® |
| AttitudeEngine™ | FRFET® |  ® | TinyBoost® |
| Awinda® | Global Power Resource™ | Power Supply WebDesigner™ | TinyBuck® |
| AX-CAP®* | GreenBridge™ | PowerTrench® | TinyCalc™ |
| BitSiC™ | Green FPS™ | PowerXS™ | TinyLogic® |
| Build it Now™ | Green FPS™ e-Series™ | Programmable Active Droop™ | TINYOPTO™ |
| CorePLUS™ | Gmax™ | QFET® | TinyPower™ |
| CorePOWER™ | GTO™ | QS™ | TinyPWM™ |
| CROSSVOLT™ | IntelliMAX™ | Quiet Series™ | TinyWire™ |
| CTL™ | ISOPLANAR™ | RapidConfigure™ | TranSiC™ |
| Current Transfer Logic™ | Making Small Speakers Sound Louder and Better™ |  ™ | TriFault Detect™ |
| DEUXPEED® | MegaBuck™ | Saving our world, 1mW/W/kW at a time™ | TRUECURRENT®* |
| Dual Cool™ | MICROCOUPLER™ | SignalWise™ | μSerDes™ |
| EcoSPARK® | MicroFET™ | SmartMax™ |  SerDes™ |
| EfficientMax™ | MicroPak™ | SMART START™ | UHC® |
| ESBC™ | MicroPak2™ | Solutions for Your Success™ | Ultra FRFET™ |
|  Fairchild® | MillerDrive™ | SPM® | UniFET™ |
| Fairchild Semiconductor® | MotionMax™ | STEALTH™ | Vcx™ |
| FACT Quiet Series™ | MotionGrid® | SuperFET® | VisualMax™ |
| FACT® | MTi® | SuperSOT™-3 | VoltagePlus™ |
| FastvCore™ | MTx® | SuperSOT™-6 | XS™ |
| FETBench™ | MVN® | SuperSOT™-8 | Xsens™ |
| FPS™ | mWSaver® | SupreMOS® | 仙童® |
| | OptoHiT™ | SyncFET™ | |
| | OPTOLOGIC® | Sync-Lock™ | |

* Trademarks of System General Corporation, used under license by Fairchild Semiconductor.

DISCLAIMER

FAIRCHILD SEMICONDUCTOR RESERVES THE RIGHT TO MAKE CHANGES WITHOUT FURTHER NOTICE TO ANY PRODUCTS HEREIN TO IMPROVE RELIABILITY, FUNCTION, OR DESIGN. TO OBTAIN THE LATEST, MOST UP-TO-DATE DATASHEET AND PRODUCT INFORMATION, VISIT OUR WEBSITE AT [HTTP://WWW.FAIRCHILDSEMI.COM](http://www.fairchildsemi.com). FAIRCHILD DOES NOT ASSUME ANY LIABILITY ARISING OUT OF THE APPLICATION OR USE OF ANY PRODUCT OR CIRCUIT DESCRIBED HEREIN; NEITHER DOES IT CONVEY ANY LICENSE UNDER ITS PATENT RIGHTS, NOR THE RIGHTS OF OTHERS. THESE SPECIFICATIONS DO NOT EXPAND THE TERMS OF FAIRCHILD'S WORLDWIDE TERMS AND CONDITIONS, SPECIFICALLY THE WARRANTY THEREIN, WHICH COVERS THESE PRODUCTS.

AUTHORIZED USE

Unless otherwise specified in this data sheet, this product is a standard commercial product and is not intended for use in applications that require extraordinary levels of quality and reliability. This product may not be used in the following applications, unless specifically approved in writing by a Fairchild officer: (1) automotive or other transportation, (2) military/aerospace, (3) any safety critical application – including life critical medical equipment – where the failure of the Fairchild product reasonably would be expected to result in personal injury, death or property damage. Customer's use of this product is subject to agreement of this Authorized Use policy. In the event of an unauthorized use of Fairchild's product, Fairchild accepts no liability in the event of product failure. In other respects, this product shall be subject to Fairchild's Worldwide Terms and Conditions of Sale, unless a separate agreement has been signed by both Parties.

ANTI-COUNTERFEITING POLICY

Fairchild Semiconductor Corporation's Anti-Counterfeiting Policy. Fairchild's Anti-Counterfeiting Policy is also stated on our external website, www.fairchildsemi.com, under Terms of Use

Counterfeiting of semiconductor parts is a growing problem in the industry. All manufacturers of semiconductor products are experiencing counterfeiting of their parts. Customers who inadvertently purchase counterfeit parts experience many problems such as loss of brand reputation, substandard performance, failed applications, and increased cost of production and manufacturing delays. Fairchild is taking strong measures to protect ourselves and our customers from the proliferation of counterfeit parts. Fairchild strongly encourages customers to purchase Fairchild parts either directly from Fairchild or from Authorized Fairchild Distributors who are listed by country on our web page cited above. Products customers buy either from Fairchild directly or from Authorized Fairchild Distributors are genuine parts, have full traceability, meet Fairchild's quality standards for handling and storage and provide access to Fairchild's full range of up-to-date technical and product information. Fairchild and our Authorized Distributors will stand behind all warranties and will appropriately address any warranty issues that may arise. Fairchild will not provide any warranty coverage or other assistance for parts bought from Unauthorized Sources. Fairchild is committed to combat this global problem and encourage our customers to do their part in stopping this practice by buying direct or from authorized distributors.

PRODUCT STATUS DEFINITIONS

Definition of Terms

Datasheet Identification	Product Status	Definition
Advance Information	Formative / In Design	Datasheet contains the design specifications for product development. Specifications may change in any manner without notice.
Preliminary	First Production	Datasheet contains preliminary data; supplementary data will be published at a later date. Fairchild Semiconductor reserves the right to make changes at any time without notice to improve design.
No Identification Needed	Full Production	Datasheet contains final specifications. Fairchild Semiconductor reserves the right to make changes at any time without notice to improve the design.
Obsolete	Not In Production	Datasheet contains specifications on a product that is discontinued by Fairchild Semiconductor. The datasheet is for reference information only.

Rev. I77

ON Semiconductor and  are trademarks of Semiconductor Components Industries, LLC dba ON Semiconductor or its subsidiaries in the United States and/or other countries. ON Semiconductor owns the rights to a number of patents, trademarks, copyrights, trade secrets, and other intellectual property. A listing of ON Semiconductor's product/patent coverage may be accessed at www.onsemi.com/site/pdf/Patent-Marking.pdf. ON Semiconductor reserves the right to make changes without further notice to any products herein. ON Semiconductor makes no warranty, representation or guarantee regarding the suitability of its products for any particular purpose, nor does ON Semiconductor assume any liability arising out of the application or use of any product or circuit, and specifically disclaims any and all liability, including without limitation special, consequential or incidental damages. Buyer is responsible for its products and applications using ON Semiconductor products, including compliance with all laws, regulations and safety requirements or standards, regardless of any support or applications information provided by ON Semiconductor. "Typical" parameters which may be provided in ON Semiconductor data sheets and/or specifications can and do vary in different applications and actual performance may vary over time. All operating parameters, including "Typicals" must be validated for each customer application by customer's technical experts. ON Semiconductor does not convey any license under its patent rights nor the rights of others. ON Semiconductor products are not designed, intended, or authorized for use as a critical component in life support systems or any FDA Class 3 medical devices or medical devices with a same or similar classification in a foreign jurisdiction or any devices intended for implantation in the human body. Should Buyer purchase or use ON Semiconductor products for any such unintended or unauthorized application, Buyer shall indemnify and hold ON Semiconductor and its officers, employees, subsidiaries, affiliates, and distributors harmless against all claims, costs, damages, and expenses, and reasonable attorney fees arising out of, directly or indirectly, any claim of personal injury or death associated with such unintended or unauthorized use, even if such claim alleges that ON Semiconductor was negligent regarding the design or manufacture of the part. ON Semiconductor is an Equal Opportunity/Affirmative Action Employer. This literature is subject to all applicable copyright laws and is not for resale in any manner.

PUBLICATION ORDERING INFORMATION

LITERATURE FULFILLMENT:

Literature Distribution Center for ON Semiconductor
19521 E. 32nd Pkwy, Aurora, Colorado 80011 USA
Phone: 303-675-2175 or 800-344-3860 Toll Free USA/Canada
Fax: 303-675-2176 or 800-344-3867 Toll Free USA/Canada
Email: orderlit@onsemi.com

N. American Technical Support: 800-282-9855 Toll Free
USA/Canada
Europe, Middle East and Africa Technical Support:
Phone: 421 33 790 2910
Japan Customer Focus Center
Phone: 81-3-5817-1050

ON Semiconductor Website: www.onsemi.com
Order Literature: <http://www.onsemi.com/orderlit>
For additional information, please contact your local
Sales Representative

Mouser Electronics

Authorized Distributor

Click to View Pricing, Inventory, Delivery & Lifecycle Information:

[ON Semiconductor:](#)

[US2GA](#)