

# ADS1286

## 12-Bit Micro Power Sampling ANALOG-TO-DIGITAL CONVERTER

### FEATURES

- SERIAL INTERFACE
- GUARANTEED NO MISSING CODES
- 20kHz SAMPLING RATE
- LOW SUPPLY CURRENT: 250 $\mu$ A

### APPLICATIONS

- REMOTE DATA ACQUISITION
- ISOLATED DATA ACQUISITION
- TRANSDUCER INTERFACE
- BATTERY OPERATED SYSTEMS

### DESCRIPTION

The ADS1286 is a 12-bit, 20kHz analog-to-digital converter with a differential input and sample and hold amplifier and consumes only 250 $\mu$ A of supply current. The ADS1286 offers an SPI and SSI compatible serial interface for communications over a two or three wire interface. The combination of a serial two wire interface and micropower consumption makes the ADS1286 ideal for remote applications and for those requiring isolation.

The ADS1286 is available in a 8-pin plastic mini DIP and a 8-lead SOIC.

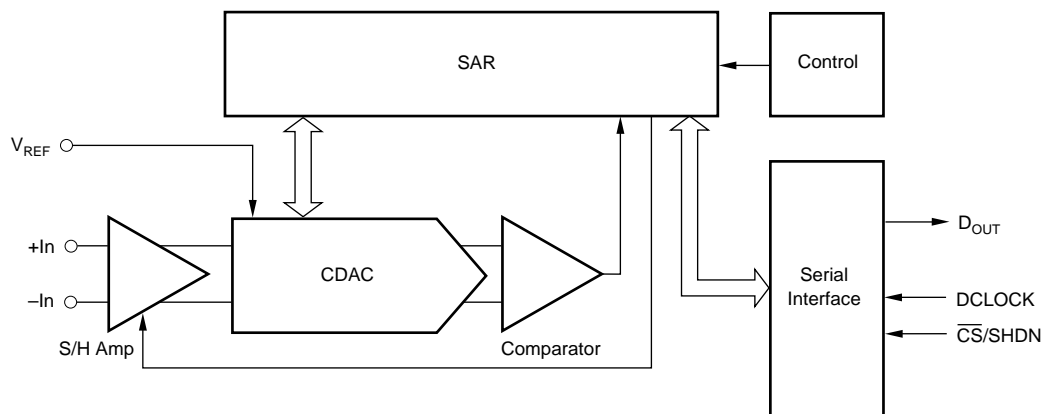

International Airport Industrial Park • Mailing Address: PO Box 11400, Tucson, AZ 85734 • Street Address: 6730 S. Tucson Blvd., Tucson, AZ 85706 • Tel: (520) 746-1111  
Twx: 910-952-1111 • Internet: <http://www.burr-brown.com/> • Cable: BBRCORP • Telex: 066-6491 • FAX: (520) 889-1510 • Immediate Product Info: (800) 548-6132

# SPECIFICATIONS

At  $T_A = T_{MIN}$  to  $T_{MAX}$ ,  $+V_{CC} = +5V$ ,  $V_{REF} = +5V$ ,  $f_{SAMPLE} = 12.5kHz$ ,  $f_{CLK} = 16 \cdot f_{SAMPLE}$ , unless otherwise specified.

PARAMETER	CONDITIONS	ADS1286, ADS1286A			ADS1286K, ADS1286B			ADS1286C, ADS1286L			UNITS
		MIN	TYP	MAX	MIN	TYP	MAX	MIN	TYP	MAX	
<b>ANALOG INPUT</b>											
Full-Scale Input Range	+In – (–In)	0		$V_{REF}$	*		*	*		*	V
Absolute Input Voltage	+In	–0.2		$V_{CC} + 0.2$	*		*	*		*	V
	–In	–0.2		+0.2	*		*	*		*	V
Capacitance			25			*			*		pF
Leakage Current			±1			*			*		µA
<b>SYSTEM PERFORMANCE</b>											
Resolution		12	12		*	*		*	*		Bits
No Missing Codes					*			*			Bits
Integral Linearity			±1	±2		*			±0.5	±1	LSB
Differential Linearity			±0.5	±1.0		*	±0.75		±0.25	±0.75	LSB
Offset Error			0.75	±3		*	*		*	*	LSB
Gain Error			±2	±8		*	*		*	*	LSB
Noise			50			*			*		µVrms
Power Supply Rejection			82			*			*		dB
<b>SAMPLING DYNAMICS</b>											
Conversion Time				12			*			*	Clk Cycles
Acquisition Time		1.5			*			*			Clk Cycles
Small Signal Bandwidth			500			*			*		kHz
<b>DYNAMIC CHARACTERISTICS</b>											
Total Harmonic Distortion	$V_{IN} = 5.0Vp-p$ at 1kHz		–85			*			*		dB
	$V_{IN} = 5.0Vp-p$ at 5kHz		–83			*			*		dB
SINAD	$V_{IN} = 5.0Vp-p$ at 1kHz		72			*			*		dB
Spurious Free Dynamic Range	$V_{IN} = 5.0Vp-p$ at 1kHz		90			*			*		dB
<b>REFERENCE INPUT</b>											
REF Input Range		1.25	2.5	$V_{CC} + 0.05V$	*	*	*	*	*	*	V
Input Resistance	$\overline{CS} = V_{CC}$		5000			*			*		MΩ
	$CS = GND, f_{CLK} = 0Hz$		5000			*			*		MΩ
Current Drain	$\overline{CS} = V_{CC}$		0.01	2.5		*	*		*	*	µA
	$t_{CYC} \geq 640\mu s, f_{CLK} \leq 25kHz$		2.4	20		*	*		*	*	µA
	$t_{CYC} = 80\mu s, f_{CLK} = 200kHz$		2.4	20		*	*		*	*	µA
<b>DIGITAL INPUT/OUTPUT</b>											
Logic Family			CMOS			*			*		
Logic Levels:											
$V_{IH}$	$I_{IH} = +5\mu A$	3		$+V_{CC}$	*		*	*	*	*	V
$V_{IL}$	$I_{IL} = +5\mu A$	0.0		0.8	*		*	*	*	*	V
$V_{OH}$	$I_{OH} = 250\mu A$	3		$+V_{CC}$	*		*	*	*	*	V
$V_{OL}$	$I_{OL} = 250\mu A$	0.0		0.4	*		*	*	*	*	V
Data Format			Straight Binary			*			*		
<b>POWER SUPPLY REQUIREMENTS</b>											
Power Supply Voltage		+4.50	5	5.25	*	*	*	*	*	*	V
Quiescent Current, $V_{ANA}$	$t_{CYC} \geq 640\mu s, f_{CLK} \leq 25kHz$		200	400		*	*	*	*	*	µA
	$t_{CYC} = 90\mu s, f_{CLK} = 200kHz$		250	500		*	*	*	*	*	µA
Power Down	$CS = V_{CC}$			3		*	*	*	*	*	µA
<b>TEMPERATURE RANGE</b>											
Specified Performance	ADS1286, K, L	0		+70	*		*	*	*	*	°C
	ADS1286A, B, C	–40		+85	*		*	*	*	*	°C

\* Specifications same as grade to the left.

## TIMING CHARACTERISTICS

$f_{CLK} = 200kHz$ ,  $T_A = T_{MIN}$  to  $T_{MAX}$ .

SYMBOL	PARAMETER	CONDITIONS	MIN	TYP	MAX	UNITS
$t_{SMPL}$	Analog Input Sample Time	See Operating Sequence	1.5		2.0	Clk Cycles
$f_{SMPL (MAX)}$	Maximum Sampling Frequency	ADS1286			20	kHz
$t_{CONV}$	Conversion Time	See Operating Sequence		12		Clk Cycles
$t_{DQO}$	Delay Time, DCLOCK↓ to D <sub>OUT</sub> Data Valid	See Test Circuits		85	150	ns
$t_{dis}$	Delay Time, $\overline{CS}$ ↑ to D <sub>OUT</sub> Hi-Z	See Test Circuits		25	50	ns
$t_{en}$	Delay Time, DCLOCK↓ to D <sub>OUT</sub> Enable	See Test Circuits		50	100	ns
$t_{hDO}$	Output Data Remains Valid After DCLOCK↓	$C_{LOAD} = 100pF$	15	30		ns
$t_f$	D <sub>OUT</sub> Fall Time	See Test Circuits		70	100	ns
$t_r$	D <sub>OUT</sub> Rise Time	See Test Circuits		60	100	ns
$t_{CSD}$	Delay Time, $\overline{CS}$ ↓ to DCLOCK↓	See Operating Sequence			0	ns
$t_{SUCS}$	Delay Time, $\overline{CS}$ ↓ to DCLOCK↑	See Operating Sequence	30			ns

## ABSOLUTE MAXIMUM RATINGS<sup>(1)</sup>

+V <sub>CC</sub> .....	+6V
Analog Input .....	-0.3V to (+V <sub>CC</sub> + 300mV)
Logic Input .....	-0.3V to (+V <sub>CC</sub> + 300mV)
Case Temperature .....	+100°C
Junction Temperature .....	+150°C
Storage Temperature .....	+125°C
External Reference Voltage .....	+5.5V

NOTE: (1) Stresses above these ratings may permanently damage the device.



## ELECTROSTATIC DISCHARGE SENSITIVITY

Electrostatic discharge can cause damage ranging from performance degradation to complete device failure. Burr-Brown Corporation recommends that all integrated circuits be handled and stored using appropriate ESD protection methods.

ESD damage can range from subtle performance degradation to complete device failure. Precision integrated circuits may be more susceptible to damage because very small parametric changes could cause the device not to meet published specifications.

## PIN CONFIGURATION

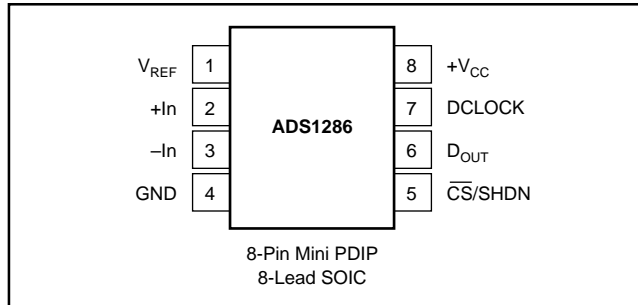

## PIN ASSIGNMENTS

PIN	NAME	DESCRIPTION
1	V <sub>REF</sub>	Reference Input.
2	+In	Non Inverting Input.
3	-In	Inverting Input. Connect to ground or remote ground sense point.
4	GND	Ground.
5	$\overline{\text{CS}}/\text{SHDN}$	Chip Select when low, Shutdown Mode when high.
6	D <sub>OUT</sub>	The serial output data word is comprised of 12 bits of data. In operation the data is valid on the falling edge of DCLOCK. The second clock pulse after the falling edge of CS enables the serial output. After one null bit the data is valid for the next 12 edges.
7	DCLOCK	Data Clock synchronizes the serial data transfer and determines conversion speed.
8	+V <sub>CC</sub>	Power Supply.

## PACKAGE/ORDERING INFORMATION

PRODUCT	INTEGRAL LINEARITY	TEMPERATURE RANGE	PACKAGE	PACKAGE DRAWING NUMBER <sup>(1)</sup>
ADS1286P	±2	0°C to +70°C	Plastic DIP	006
ADS1286PK	±2	0°C to +70°C	Plastic DIP	006
ADS1286PL	±1	0°C to +70°C	Plastic DIP	006
ADS1286U	±2	0°C to +70°C	SOIC	182
ADS1286UK	±2	0°C to +70°C	SOIC	182
ADS1286UL	±1	0°C to +70°C	SOIC	182
ADS1286PA	±2	-40°C to +85°C	Plastic DIP	006
ADS1286PB	±2	-40°C to +85°C	Plastic DIP	006
ADS1286PC	±1	-40°C to +85°C	Plastic DIP	006
ADS1286UA	±2	-40°C to +85°C	SOIC	182
ADS1286UB	±2	-40°C to +85°C	SOIC	182
ADS1286UC	±1	-40°C to +85°C	SOIC	182

NOTE: (1) For detailed drawing and dimension table, please see end of data sheet, or Appendix C of Burr-Brown IC Data Book.

The information provided herein is believed to be reliable; however, BURR-BROWN assumes no responsibility for inaccuracies or omissions. BURR-BROWN assumes no responsibility for the use of this information, and all use of such information shall be entirely at the user's own risk. Prices and specifications are subject to change without notice. No patent rights or licenses to any of the circuits described herein are implied or granted to any third party. BURR-BROWN does not authorize or warrant any BURR-BROWN product for use in life support devices and/or systems.

# TYPICAL PERFORMANCE CURVES

At  $T_A = +25$ ,  $V_{CC} = +5V$ ,  $V_{REF} = +5V$ ,  $f_{SAMPLE} = 12.5kHz$ ,  $f_{CLK} = 16 \cdot f_{SAMPLE}$ , unless otherwise specified.

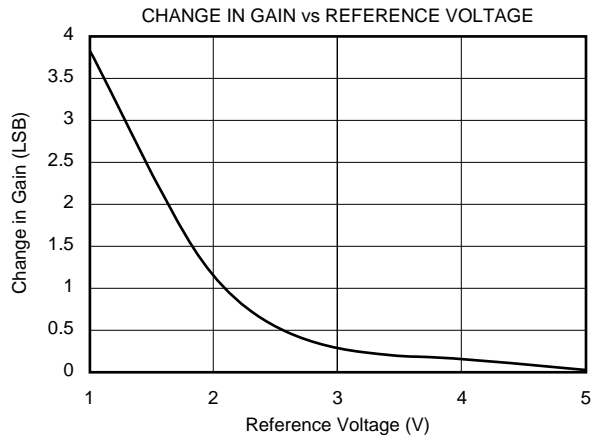
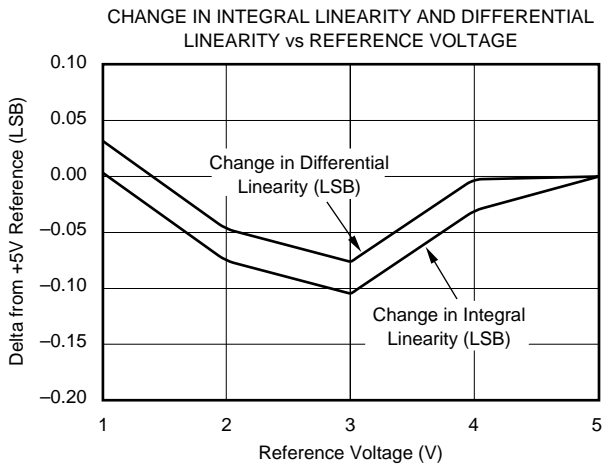
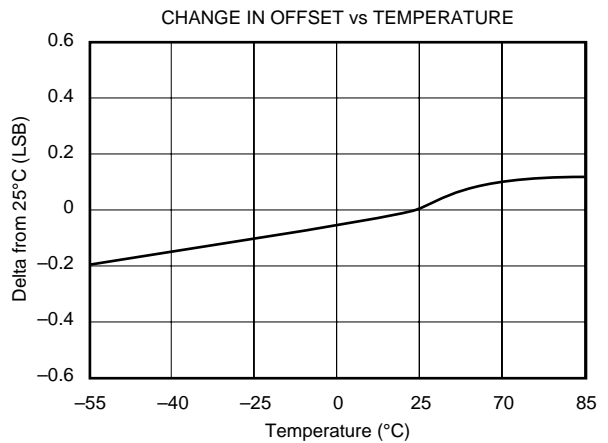
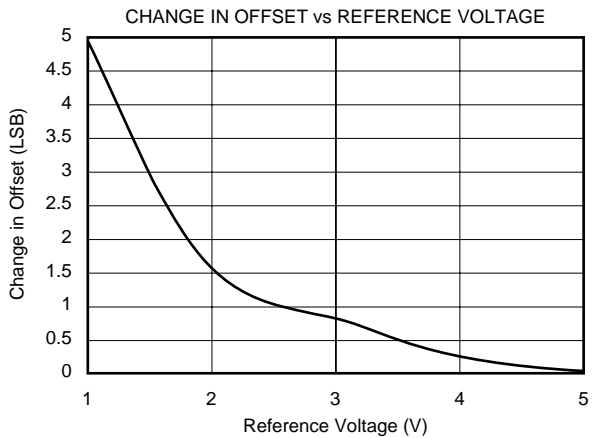
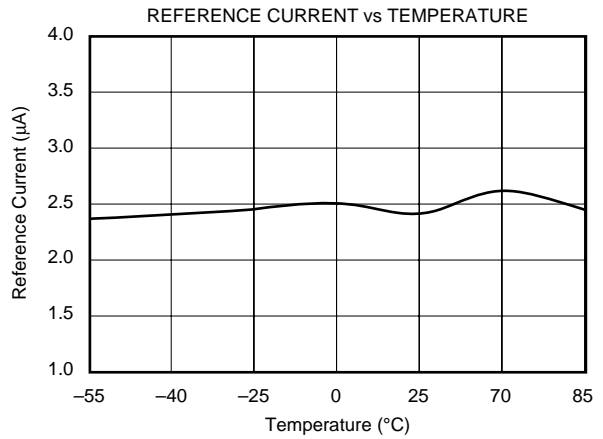
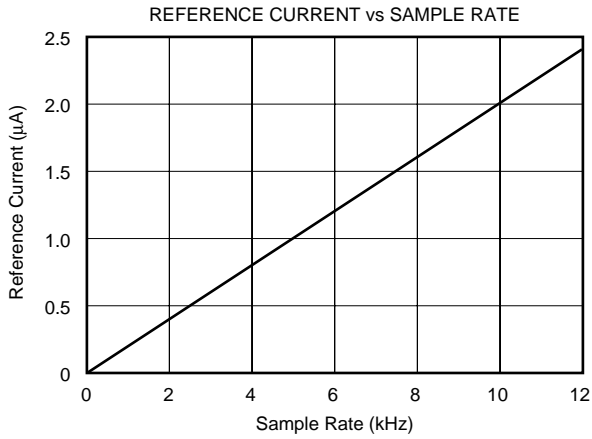

# TYPICAL PERFORMANCE CURVES (CONT)

At  $T_A = +25$ ,  $V_{CC} = +5V$ ,  $V_{REF} = +5V$ ,  $f_{SAMPLE} = 12.5kHz$ ,  $f_{CLK} = 16 \cdot f_{SAMPLE}$ , unless otherwise specified.

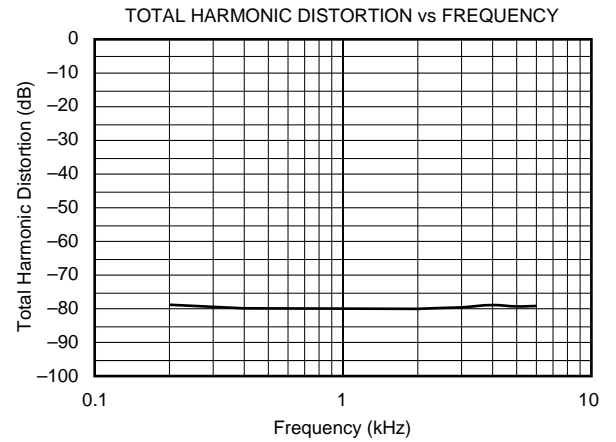
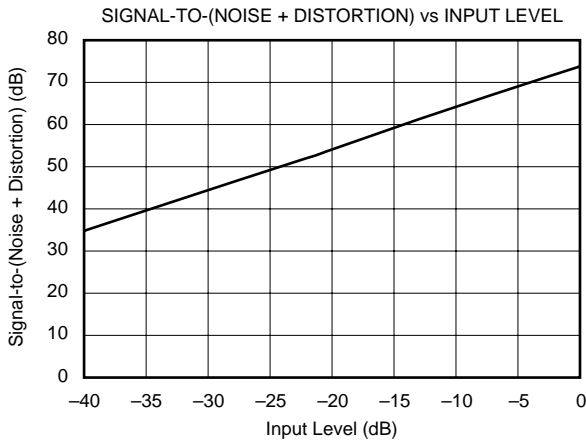
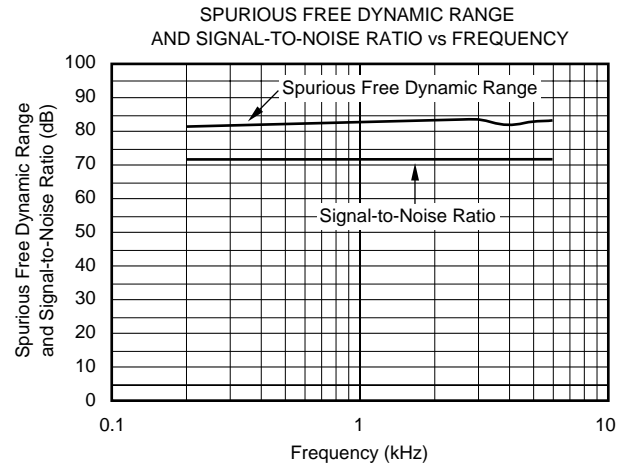
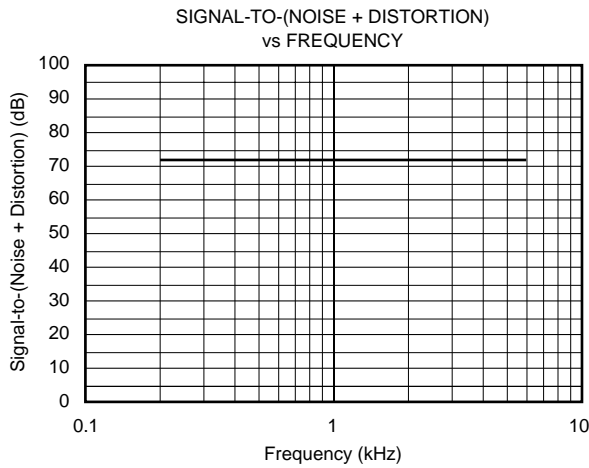
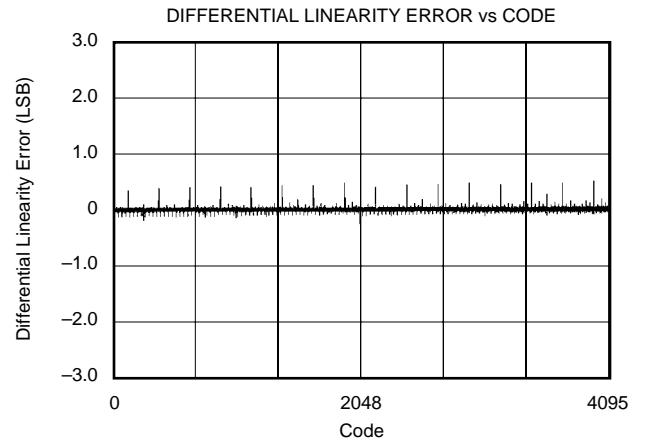
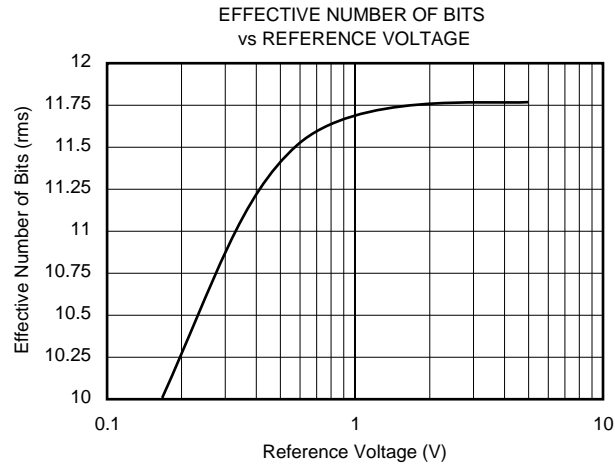

# TYPICAL PERFORMANCE CURVES (CONT)

At  $T_A = +25$ ,  $V_{CC} = +5V$ ,  $V_{REF} = +5V$ ,  $f_{SAMPLE} = 12.5kHz$ ,  $f_{CLK} = 16 \cdot f_{SAMPLE}$ , unless otherwise specified.

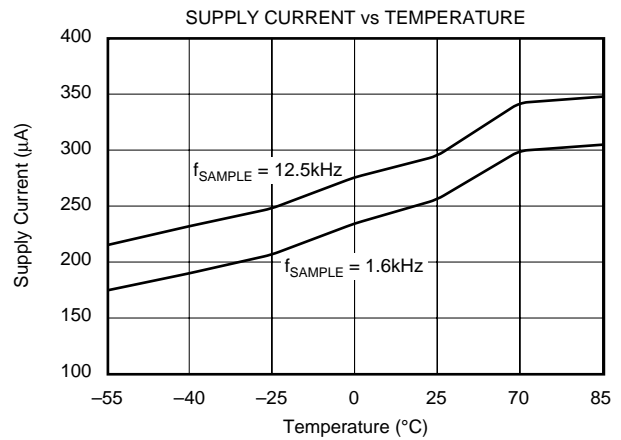
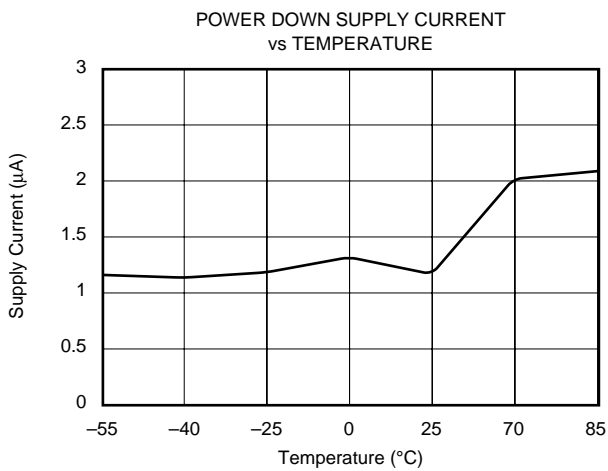
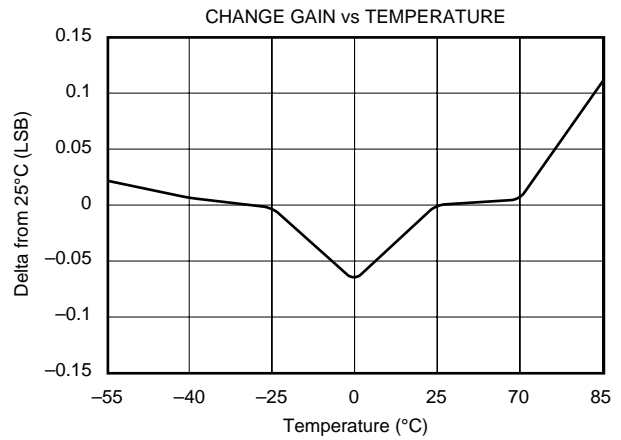
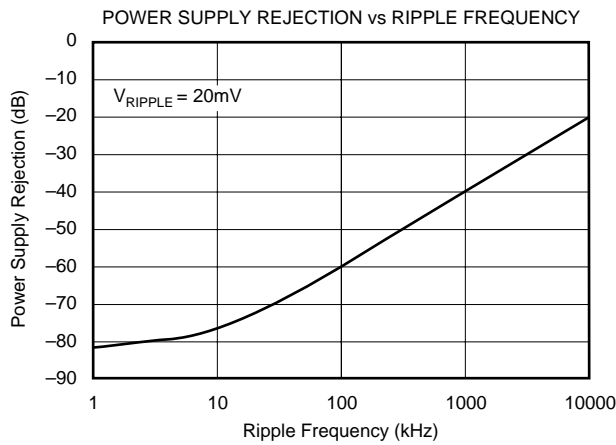
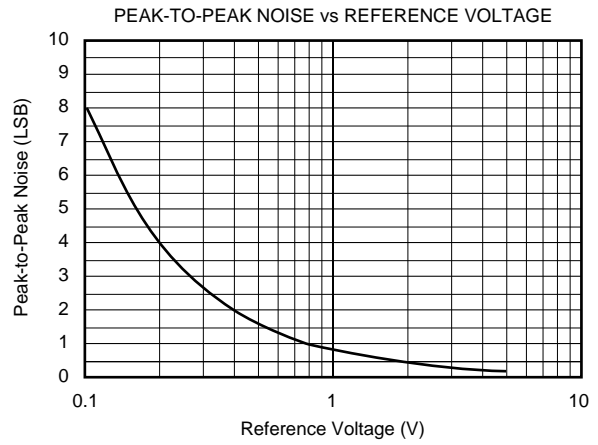
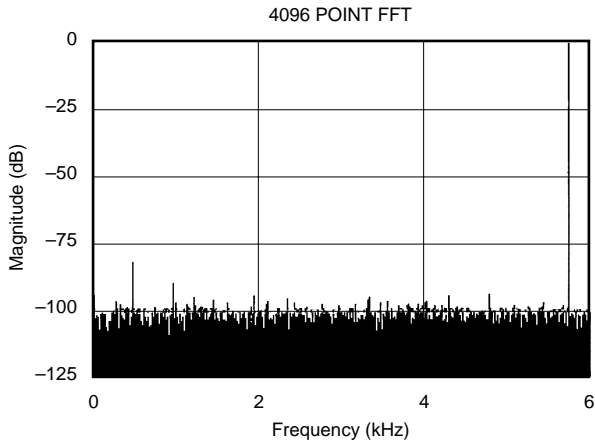

# TYPICAL PERFORMANCE CURVES (CONT)

At  $T_A = +25$ ,  $V_{CC} = +5V$ ,  $V_{REF} = +5V$ ,  $f_{SAMPLE} = 12.5kHz$ ,  $f_{CLK} = 16 \cdot f_{SAMPLE}$ , unless otherwise specified.

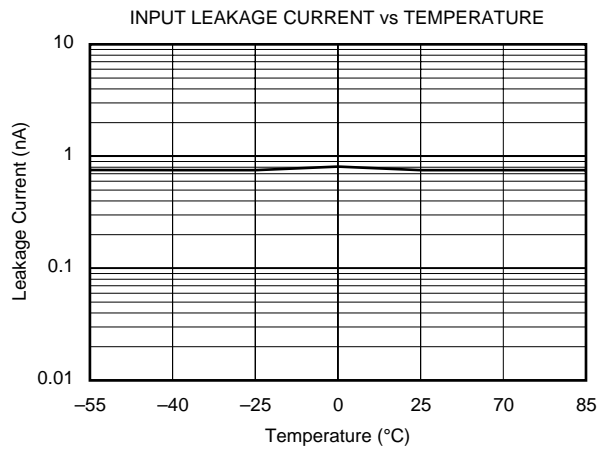
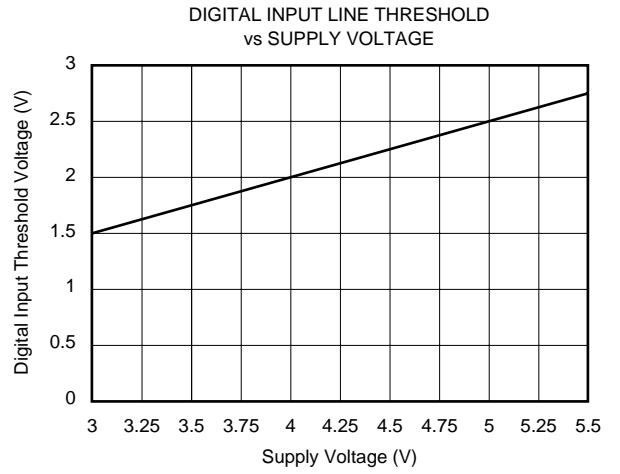
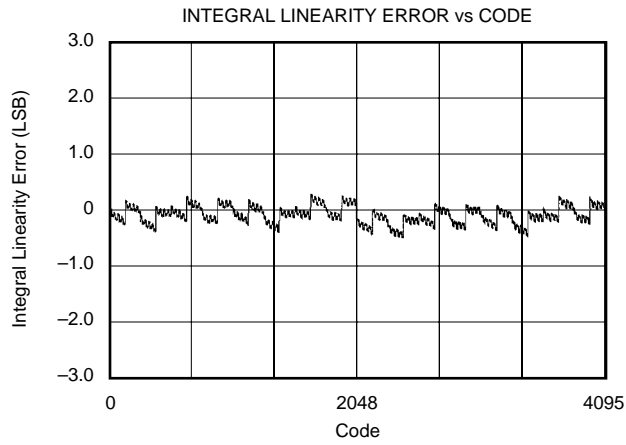

# TIMING DIAGRAMS AND TEST CIRCUITS

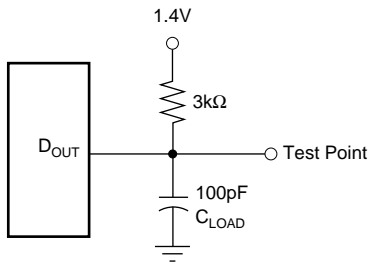

Load Circuit for  $t_{dDO}$ ,  $t_r$ , and  $t_f$



Voltage Waveforms for  $D_{OUT}$  Rise and Fall Times  $t_r$  and  $t_f$

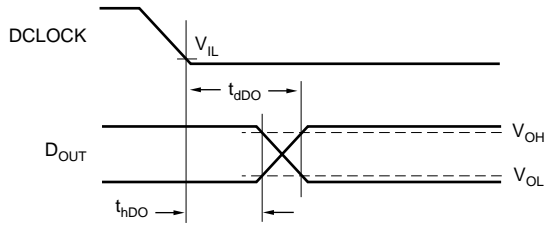

Voltage Waveforms for  $D_{OUT}$  Delay Times,  $t_{dDO}$

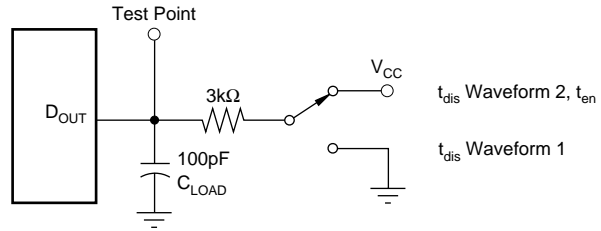

Load Circuit for  $t_{dis}$  and  $t_{den}$

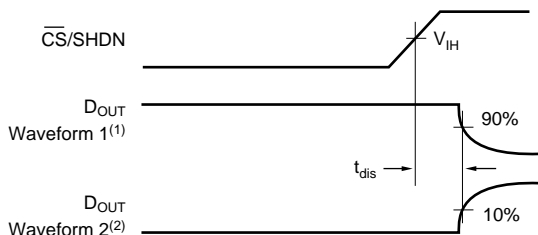

Voltage Waveforms for  $t_{dis}$

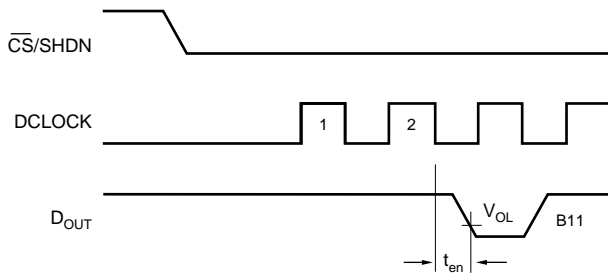

Voltage Waveforms for  $t_{en}$

NOTES: (1) Waveform 1 is for an output with internal conditions such that the output is HIGH unless disabled by the output control. (2) Waveform 2 is for an output with internal conditions such that the output is LOW unless disabled by the output control.



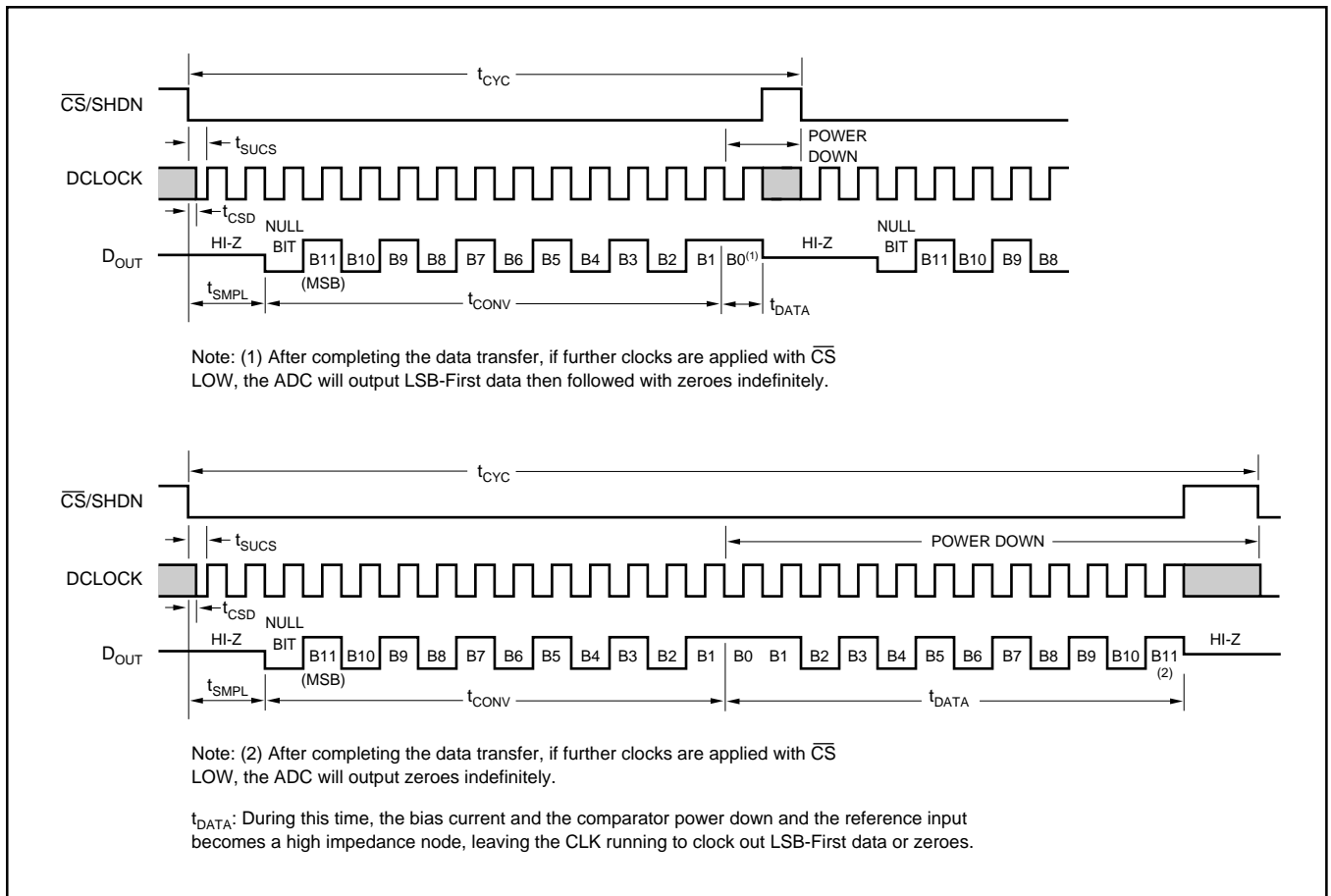

FIGURE 1. ADS1286 Operating Sequence.

## SERIAL INTERFACE

The ADS1286 communicates with microprocessors and other external digital systems via a synchronous 3-wire serial interface. DCLOCK synchronizes the data transfer with each bit being transmitted on the falling DCLOCK edge and captured on the rising DCLOCK edge in the receiving system. A falling  $\overline{CS}$  initiates data transfer as shown in Figure 1. After  $\overline{CS}$  falls, the second DCLOCK pulse enables  $D_{OUT}$ . After one null bit, the A/D conversion result is output on the  $D_{OUT}$  line. Bringing  $\overline{CS}$  high resets the ADS1286 for the next data exchange.

## MICROPOWER OPERATION

With typical operating currents of 250 $\mu$ A and automatic shutdown between conversions, the ADS1286 achieves extremely low power consumption over a wide range of sample rates (see Figure 2). The auto-shutdown allows the supply current to drop with sample rate.

### SHUTDOWN

The ADS1286 is equipped with automatic shutdown features. The device draws power when the  $\overline{CS}$  pin is LOW and shuts down completely when the pin is HIGH. The bias circuit and comparator powers down and the reference input becomes high impedance at the end of each conversion

leaving the DCLOCK running to clock out the LSB first data or zeroes. If the  $\overline{CS}$  input is not running rail-to-rail, the input logic buffer will draw current. This current may be large compared to the typical supply current. To obtain the lowest supply current, bring the  $\overline{CS}$  pin to ground when it is low and to supply voltage when it is high.

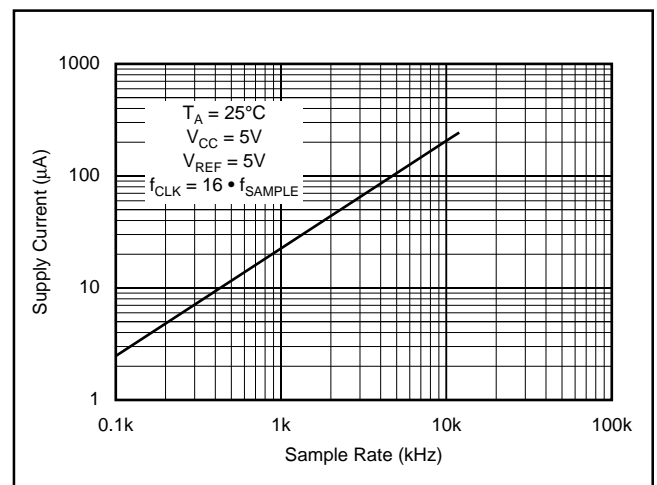

FIGURE 2. Automatic Power Shutdown Between Conversions Allows Power Consumption to Drop with Sample Rate.

## MINIMIZING POWER DISSIPATION

In systems that have significant time between conversions, the lowest power drain will occur with the minimum  $\overline{CS}$  LOW time. Bringing  $\overline{CS}$  LOW, transferring data as quickly as possible, and then bringing it back HIGH will result in the lowest current drain. This minimizes the amount of time the device draws power. After a conversion the A/D automatically shuts down even if  $\overline{CS}$  is held LOW. If the clock is left running to clock out LSB-data or zero, the logic will draw a small amount of current (see Figure 3).

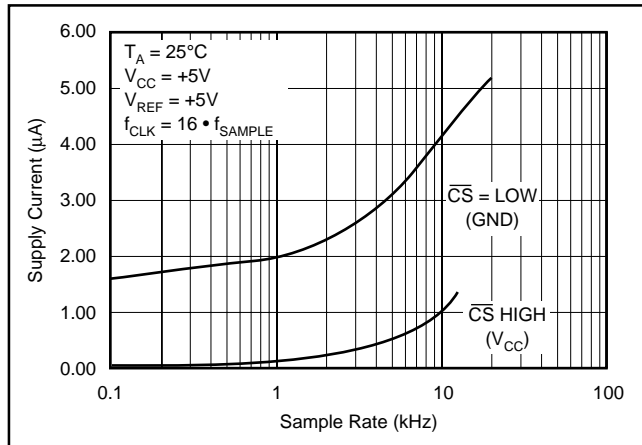

FIGURE 3. Shutdown Current with  $\overline{CS}$  HIGH is Lower than with  $\overline{CS}$  LOW.

## RC INPUT FILTERING

It is possible to filter the inputs with an RC network as shown in Figure 4. For large values of  $C_{FILTER}$  (e.g., 1µF), the capacitive input switching currents are averaged into a net DC current. Therefore, a filter should be chosen with a small resistor and large capacitor to prevent DC drops across the resistor. The magnitude of the DC current is approximately  $I_{DC} = 20\text{pF} \times V_{IN}/t_{CYC}$  and is roughly proportional to  $V_{IN}$ . When running at the minimum cycle time of 64µs, the input current equals 1.56µA at  $V_{IN} = 5\text{V}$ . In this case, a filter resistor of 75Ω will cause 0.1LSB of full-scale error. If a larger filter resistor must be used, errors can be eliminated by increasing the cycle time.

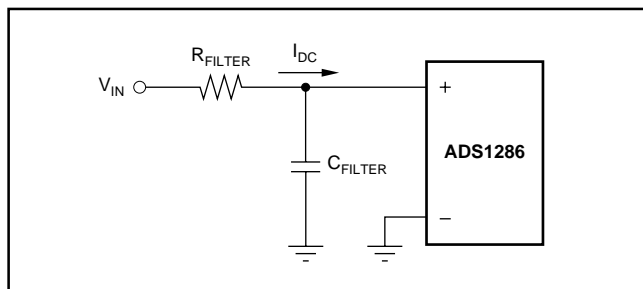

FIGURE 4. RC Input Filtering.

## REDUCED REFERENCE OPERATION

The effective resolution of the ADS1286 can be increased by reducing the input span of the converter. The ADS1286 exhibits good linearity and gain over a wide range of reference voltages (see Typical Performance Curves “Change in Linearity vs Reference Voltage” and “Change in Gain vs Reference Voltage”). However, care must be taken when operating at low values of  $V_{REF}$  because of the reduced LSB size and the resulting higher accuracy requirement placed on the converter. The following factors must be considered when operating at low  $V_{REF}$  values:

1. Offset
2. Noise

### OFFSET WITH REDUCED $V_{REF}$

The offset of the ADS1286 has a larger effect on the output code. When the ADC is operated with reduced reference voltage. The offset (which is typically a fixed voltage) becomes a larger fraction of an LSB as the size of the LSB is reduced. The Typical Performance Curve “Change in Offset vs Reference Voltage” shows how offset in LSBs is related to reference voltage for a typical value of  $V_{OS}$ . For example, a  $V_{OS}$  of 122µV which is 0.1 LSB with a 5V reference becomes 0.5LSB with a 1V reference and 2.5LSBs with a 0.2V reference. If this offset is unacceptable, it can be corrected digitally by the receiving system or by offsetting the negative input of the ADS1286.

### NOISE WITH REDUCED $V_{REF}$

The total input referred noise of the ADS1286 can be reduced to approximately 200µV peak-to-peak using a ground plane, good bypassing, good layout techniques and minimizing noise on the reference inputs. This noise is insignificant with a 5V reference but will become a larger fraction of an LSB as the size of the LSB is reduced.

For operation with a 5V reference, the 200µV noise is only 0.15LSB peak-to-peak. In this case, the ADS1286 noise will contribute virtually no uncertainty to the output code. However, for reduced references, the noise may become a significant fraction of an LSB and cause undesirable jitter in the output code. For example, with a 2.5V reference this same 200µV noise is 0.3LSB peak-to-peak. If the reference is further reduced to 1V, the 200µV noise becomes equal to 0.8LSBs and a stable code may be difficult to achieve. In this case averaging multiple readings may be necessary.

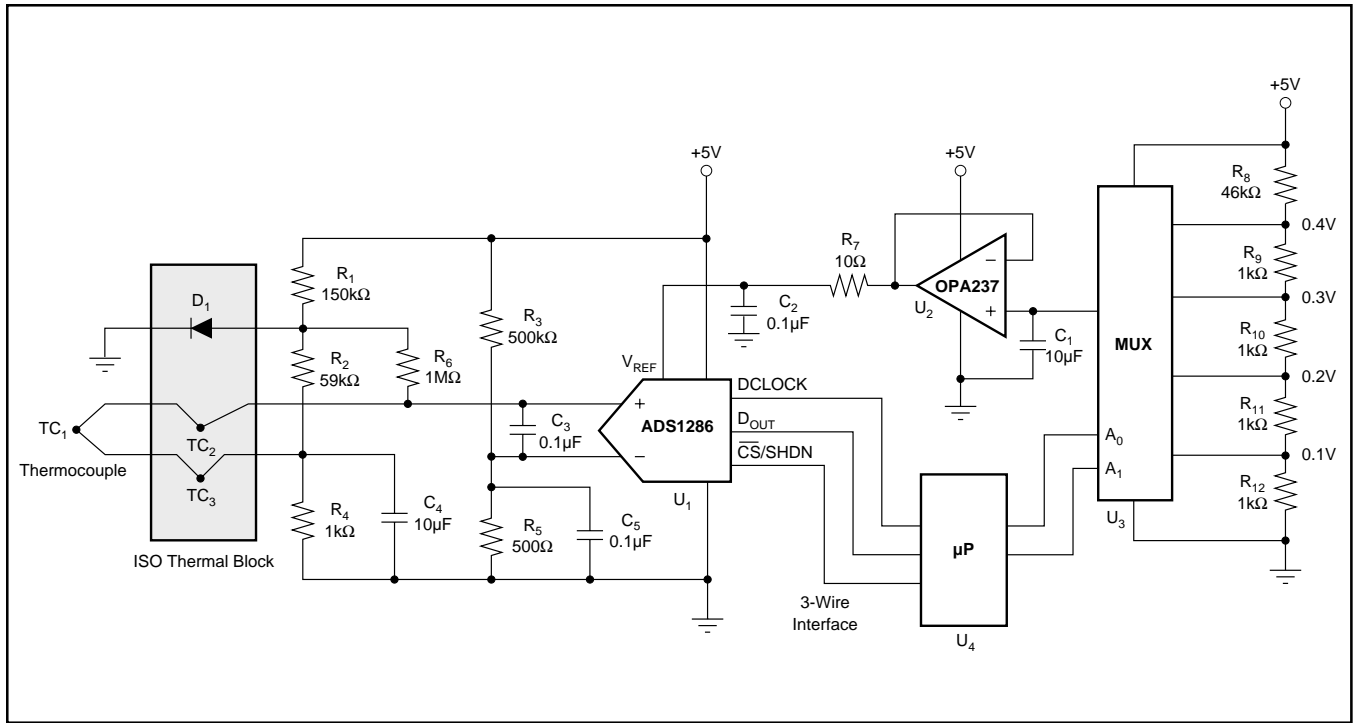

FIGURE 5. Thermocouple Application Using a MUX to Scale the Input Range of the ADS1286.

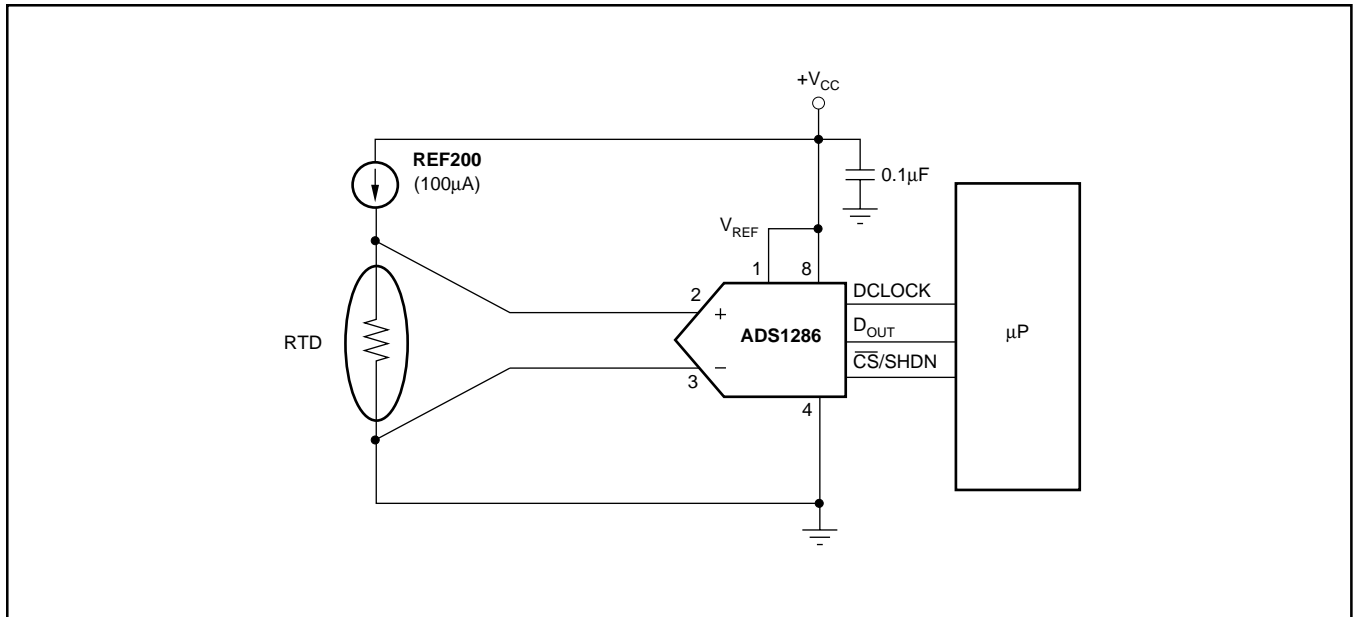

FIGURE 6. ADS1286 with RTD Sensor.

**PACKAGING INFORMATION**

Orderable Device	Status (1)	Package Type	Package Drawing	Pins	Package Qty	Eco Plan (2)	Lead/Ball Finish (6)	MSL Peak Temp (3)	Op Temp (°C)	Device Marking (4/5)	Samples
ADS1286UA	ACTIVE	SOIC	D	8	75	Green (RoHS & no Sb/Br)	NIPDAU	Level-2-260C-1 YEAR	-40 to 85	ADS 1286U A	<a href="#">Samples</a>
ADS1286UA/2K5	ACTIVE	SOIC	D	8	2500	Green (RoHS & no Sb/Br)	NIPDAU	Level-2-260C-1 YEAR	-40 to 85	ADS 1286U A	<a href="#">Samples</a>
ADS1286UA/2K5G4	ACTIVE	SOIC	D	8	2500	Green (RoHS & no Sb/Br)	NIPDAU	Level-2-260C-1 YEAR	-40 to 85	ADS 1286U A	<a href="#">Samples</a>
ADS1286UAG4	ACTIVE	SOIC	D	8	75	Green (RoHS & no Sb/Br)	NIPDAU	Level-2-260C-1 YEAR	-40 to 85	ADS 1286U A	<a href="#">Samples</a>
ADS1286UB	ACTIVE	SOIC	D	8	75	Green (RoHS & no Sb/Br)	NIPDAU	Level-2-260C-1 YEAR	-40 to 85	ADS 1286U B	<a href="#">Samples</a>
ADS1286UC	ACTIVE	SOIC	D	8	75	Green (RoHS & no Sb/Br)	NIPDAU	Level-3-260C-168 HR	-40 to 85	ADS 1286U C	<a href="#">Samples</a>
ADS1286UCG4	ACTIVE	SOIC	D	8	75	Green (RoHS & no Sb/Br)	NIPDAU	Level-3-260C-168 HR	-40 to 85	ADS 1286U C	<a href="#">Samples</a>
ADS1286UL/2K5	ACTIVE	SOIC	D	8	2500	Green (RoHS & no Sb/Br)	NIPDAU	Level-2-260C-1 YEAR	-40 to 85	ADS 1286U L	<a href="#">Samples</a>

(1) The marketing status values are defined as follows:

**ACTIVE:** Product device recommended for new designs.

**LIFEBUY:** TI has announced that the device will be discontinued, and a lifetime-buy period is in effect.

**NRND:** Not recommended for new designs. Device is in production to support existing customers, but TI does not recommend using this part in a new design.

**PREVIEW:** Device has been announced but is not in production. Samples may or may not be available.

**OBSOLETE:** TI has discontinued the production of the device.

(2) **RoHS:** TI defines "RoHS" to mean semiconductor products that are compliant with the current EU RoHS requirements for all 10 RoHS substances, including the requirement that RoHS substance do not exceed 0.1% by weight in homogeneous materials. Where designed to be soldered at high temperatures, "RoHS" products are suitable for use in specified lead-free processes. TI may reference these types of products as "Pb-Free".

**RoHS Exempt:** TI defines "RoHS Exempt" to mean products that contain lead but are compliant with EU RoHS pursuant to a specific EU RoHS exemption.

---

**Green:** TI defines "Green" to mean the content of Chlorine (Cl) and Bromine (Br) based flame retardants meet JS709B low halogen requirements of  $\leq 1000$ ppm threshold. Antimony trioxide based flame retardants must also meet the  $\leq 1000$ ppm threshold requirement.

(3) MSL, Peak Temp. - The Moisture Sensitivity Level rating according to the JEDEC industry standard classifications, and peak solder temperature.

(4) There may be additional marking, which relates to the logo, the lot trace code information, or the environmental category on the device.

(5) Multiple Device Markings will be inside parentheses. Only one Device Marking contained in parentheses and separated by a "~" will appear on a device. If a line is indented then it is a continuation of the previous line and the two combined represent the entire Device Marking for that device.

(6) Lead/Ball Finish - Orderable Devices may have multiple material finish options. Finish options are separated by a vertical ruled line. Lead/Ball Finish values may wrap to two lines if the finish value exceeds the maximum column width.

**Important Information and Disclaimer:** The information provided on this page represents TI's knowledge and belief as of the date that it is provided. TI bases its knowledge and belief on information provided by third parties, and makes no representation or warranty as to the accuracy of such information. Efforts are underway to better integrate information from third parties. TI has taken and continues to take reasonable steps to provide representative and accurate information but may not have conducted destructive testing or chemical analysis on incoming materials and chemicals. TI and TI suppliers consider certain information to be proprietary, and thus CAS numbers and other limited information may not be available for release.

In no event shall TI's liability arising out of such information exceed the total purchase price of the TI part(s) at issue in this document sold by TI to Customer on an annual basis.

## TAPE AND REEL INFORMATION



### QUADRANT ASSIGNMENTS FOR PIN 1 ORIENTATION IN TAPE



\*All dimensions are nominal

Device	Package Type	Package Drawing	Pins	SPQ	Reel Diameter (mm)	Reel Width W1 (mm)	A0 (mm)	B0 (mm)	K0 (mm)	P1 (mm)	W (mm)	Pin1 Quadrant
ADS1286UA/2K5	SOIC	D	8	2500	330.0	12.4	6.4	5.2	2.1	8.0	12.0	Q1
ADS1286UL/2K5	SOIC	D	8	2500	330.0	12.4	6.4	5.2	2.1	8.0	12.0	Q1

**TAPE AND REEL BOX DIMENSIONS**

\*All dimensions are nominal

Device	Package Type	Package Drawing	Pins	SPQ	Length (mm)	Width (mm)	Height (mm)
ADS1286UA/2K5	SOIC	D	8	2500	367.0	367.0	35.0
ADS1286UL/2K5	SOIC	D	8	2500	367.0	367.0	35.0

## IMPORTANT NOTICE AND DISCLAIMER

TI PROVIDES TECHNICAL AND RELIABILITY DATA (INCLUDING DATASHEETS), DESIGN RESOURCES (INCLUDING REFERENCE DESIGNS), APPLICATION OR OTHER DESIGN ADVICE, WEB TOOLS, SAFETY INFORMATION, AND OTHER RESOURCES "AS IS" AND WITH ALL FAULTS, AND DISCLAIMS ALL WARRANTIES, EXPRESS AND IMPLIED, INCLUDING WITHOUT LIMITATION ANY IMPLIED WARRANTIES OF MERCHANTABILITY, FITNESS FOR A PARTICULAR PURPOSE OR NON-INFRINGEMENT OF THIRD PARTY INTELLECTUAL PROPERTY RIGHTS.

These resources are intended for skilled developers designing with TI products. You are solely responsible for (1) selecting the appropriate TI products for your application, (2) designing, validating and testing your application, and (3) ensuring your application meets applicable standards, and any other safety, security, or other requirements. These resources are subject to change without notice. TI grants you permission to use these resources only for development of an application that uses the TI products described in the resource. Other reproduction and display of these resources is prohibited. No license is granted to any other TI intellectual property right or to any third party intellectual property right. TI disclaims responsibility for, and you will fully indemnify TI and its representatives against, any claims, damages, costs, losses, and liabilities arising out of your use of these resources.

TI's products are provided subject to TI's Terms of Sale ([www.ti.com/legal/termsofsale.html](http://www.ti.com/legal/termsofsale.html)) or other applicable terms available either on [ti.com](http://ti.com) or provided in conjunction with such TI products. TI's provision of these resources does not expand or otherwise alter TI's applicable warranties or warranty disclaimers for TI products.

Mailing Address: Texas Instruments, Post Office Box 655303, Dallas, Texas 75265  
Copyright © 2020, Texas Instruments Incorporated