

# 2N3771, 2N3772

## High Power NPN Silicon Power Transistors

These devices are designed for linear amplifiers, series pass regulators, and inductive switching applications.

### Features

- Forward Biased Second Breakdown Current Capability  
 $I_{S/b} = 3.75 \text{ Adc @ } V_{CE} = 40 \text{ Vdc} - 2N3771$   
 $= 2.5 \text{ Adc @ } V_{CE} = 60 \text{ Vdc} - 2N3772$
- These Devices are Pb-Free and are RoHS Compliant

### MAXIMUM RATINGS (Note 1)

Rating	Symbol	2N3771	2N3772	Unit
Collector-Emitter Voltage	$V_{CEO}$	40	60	Vdc
Collector-Emitter Voltage	$V_{CEX}$	50	80	Vdc
Collector-Base Voltage	$V_{CB}$	50	100	Vdc
Emitter-Base Voltage	$V_{EB}$	5.0	7.0	Vdc
Collector Current – Continuous Peak	$I_C$	30 30	20 30	Adc
Base Current – Continuous Peak	$I_B$	7.5 15	5.0 15	Adc
Total Device Dissipation @ $T_C = 25^\circ\text{C}$ Derate above $25^\circ\text{C}$	$P_D$	150 0.855		W W/ $^\circ\text{C}$
Operating and Storage Junction Temperature Range	$T_J, T_{stg}$	-65 to +200		$^\circ\text{C}$

### THERMAL CHARACTERISTICS

Characteristic	Symbol	Max	Unit
Thermal Resistance, Junction-to-Case	$\theta_{JC}$	1.17	$^\circ\text{C/W}$

Stresses exceeding those listed in the Maximum Ratings table may damage the device. If any of these limits are exceeded, device functionality should not be assumed, damage may occur and reliability may be affected.

1. Indicates JEDEC registered data.



**ON Semiconductor®**

[www.onsemi.com](http://www.onsemi.com)

**20 and 30 AMPERE  
POWER TRANSISTORS  
NPN SILICON  
40 and 60 VOLTS, 150 WATTS**

### MARKING DIAGRAM

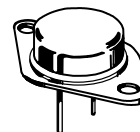

**TO-204AA (TO-3)  
CASE 1-07  
STYLE 1**

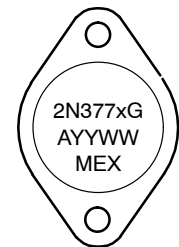

2N377x = Device Code  
 x = 1 or 2  
 G = Pb-Free Package  
 A = Assembly Location  
 YY = Year  
 WW = Work Week  
 MEX = Country of Origin

### ORDERING INFORMATION

Device	Package	Shipping
2N3771G	TO-204 (Pb-Free)	100 Units / Tray
2N3772G	TO-204 (Pb-Free)	100 Units / Tray

## 2N3771, 2N3772

### ELECTRICAL CHARACTERISTICS (T<sub>C</sub> = 25°C unless otherwise noted)

Characteristic		Symbol	Min	Max	Unit
<b>OFF CHARACTERISTICS</b>					
Collector–Emitter Sustaining Voltage (Note 2 and 3) (I <sub>C</sub> = 0.2 Adc, I <sub>B</sub> = 0)	2N3771 2N3772	V <sub>CEO(sus)</sub>	40 60	– –	Vdc
Collector–Emitter Sustaining Voltage (I <sub>C</sub> = 0.2 Adc, V <sub>EB(off)</sub> = 1.5 Vdc, R <sub>BE</sub> = 100 Ω)	2N3771 2N3772	V <sub>CEX(sus)</sub>	50 80	– –	Vdc
Collector–Emitter Sustaining Voltage (I <sub>C</sub> = 0.2 Adc, R <sub>BE</sub> = 100 Ω)	2N3771 2N3772	V <sub>CER(sus)</sub>	45 70	– –	Vdc
Collector Cutoff Current (Note 2) (V <sub>CE</sub> = 30 Vdc, I <sub>B</sub> = 0) (V <sub>CE</sub> = 50 Vdc, I <sub>B</sub> = 0) (V <sub>CE</sub> = 25 Vdc, I <sub>B</sub> = 0)	2N3771 2N3772	I <sub>CEO</sub>	– –	10 10	mAdc
Collector Cutoff Current (Note 2) (V <sub>CE</sub> = 50 Vdc, V <sub>EB(off)</sub> = 1.5 Vdc) (V <sub>CE</sub> = 100 Vdc, V <sub>EB(off)</sub> = 1.5 Vdc) (V <sub>CE</sub> = 45 Vdc, V <sub>EB(off)</sub> = 1.5 Vdc) (V <sub>CE</sub> = 30 Vdc, V <sub>EB(off)</sub> = 1.5 Vdc, T <sub>C</sub> = 150°C)  (V <sub>CE</sub> = 45 Vdc, V <sub>EB(off)</sub> = 1.5 Vdc, T <sub>C</sub> = 150°C)	2N3771 2N3772 2N6257 2N3771 2N3772	I <sub>CEV</sub>	– – – – –	2.0 5.0 4.0 10 10	mAdc
Collector Cutoff Current (Note 2) (V <sub>CB</sub> = 50 Vdc, I <sub>E</sub> = 0) (V <sub>CB</sub> = 100 Vdc, I <sub>E</sub> = 0)	2N3771 2N3772	I <sub>CB0</sub>	– –	2.0 5.0	mAdc
Emitter Cutoff Current (Note 2) (V <sub>BE</sub> = 5.0 Vdc, I <sub>C</sub> = 0) (V <sub>BE</sub> = 7.0 Vdc, I <sub>C</sub> = 0)	2N3771 2N3772	I <sub>EBO</sub>	– –	5.0 5.0	mAdc
<b>ON CHARACTERISTICS (Note 2)</b>					
DC Current Gain (Note 3) (I <sub>C</sub> = 15 Adc, V <sub>CE</sub> = 4.0 Vdc) (I <sub>C</sub> = 10 Adc, V <sub>CE</sub> = 4.0 Vdc) (I <sub>C</sub> = 8.0 Adc, V <sub>CE</sub> = 4.0 Vdc) (I <sub>C</sub> = 30 Adc, V <sub>CE</sub> = 4.0 Vdc) (I <sub>C</sub> = 20 Adc, V <sub>CE</sub> = 4.0 Vdc)	2N3771 2N3772 2N3771 2N3772	h <sub>FE</sub>	15 15 5.0 5.0	60 60 – –	–
Collector–Emitter Saturation Voltage (I <sub>C</sub> = 15 Adc, I <sub>B</sub> = 1.5 Adc) (I <sub>C</sub> = 10 Adc, I <sub>B</sub> = 1.0 Adc) (I <sub>C</sub> = 30 Adc, I <sub>B</sub> = 6.0 Adc) (I <sub>C</sub> = 20 Adc, I <sub>B</sub> = 4.0 Adc)	2N3771 2N3772 2N3771 2N3772	V <sub>CE(sat)</sub>	– – – –	2.0 1.4 4.0 4.0	Vdc
Base–Emitter On Voltage (I <sub>C</sub> = 15 Adc, V <sub>CE</sub> = 4.0 Vdc) (I <sub>C</sub> = 10 Adc, V <sub>CE</sub> = 4.0 Vdc) (I <sub>C</sub> = 8.0 Adc, V <sub>CE</sub> = 4.0 Vdc)	2N3771 2N3772	V <sub>BE(on)</sub>	– –	2.7 2.2	Vdc
<b>*DYNAMIC CHARACTERISTICS (Note 2)</b>					
Current–Gain — Bandwidth Product (I <sub>C</sub> = 1.0 Adc, V <sub>CE</sub> = 4.0 Vdc, f <sub>test</sub> = 50 kHz)		f <sub>T</sub>	0.2	–	MHz
Small–Signal Current Gain (I <sub>C</sub> = 1.0 Adc, V <sub>CE</sub> = 4.0 Vdc, f = 1.0 kHz)		h <sub>fe</sub>	40	–	–
<b>SECOND BREAKDOWN</b>					
Second Breakdown Energy with Base Forward Biased, t = 1.0 s (non–repetitive) (V <sub>CE</sub> = 40 Vdc) (V <sub>CE</sub> = 60 Vdc)	2N3771 2N3772	I <sub>S/b</sub>	3.75 2.5	– –	Adc

2. Indicates JEDEC registered data.

3. Pulse Test: 300 μs, Rep. Rate 60 cps.

## 2N3771, 2N3772

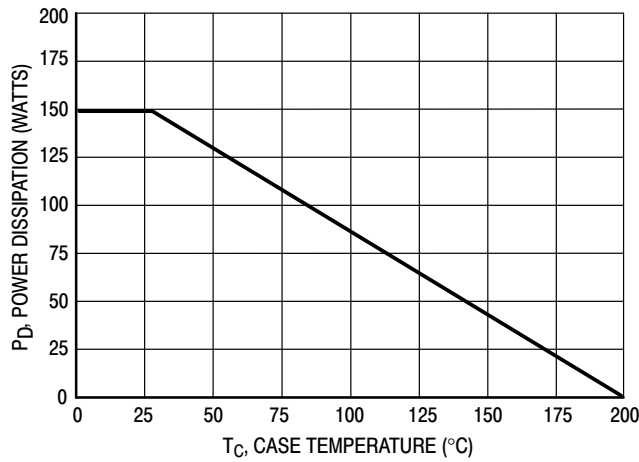

**Figure 1. Power Derating**

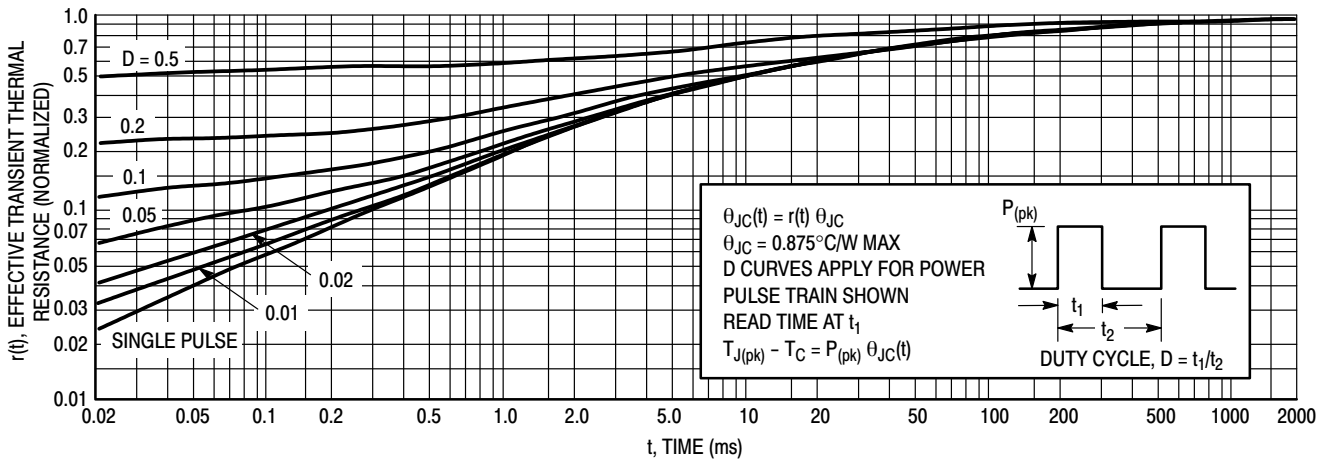

**Figure 2. Thermal Response — 2N3771, 2N3772**

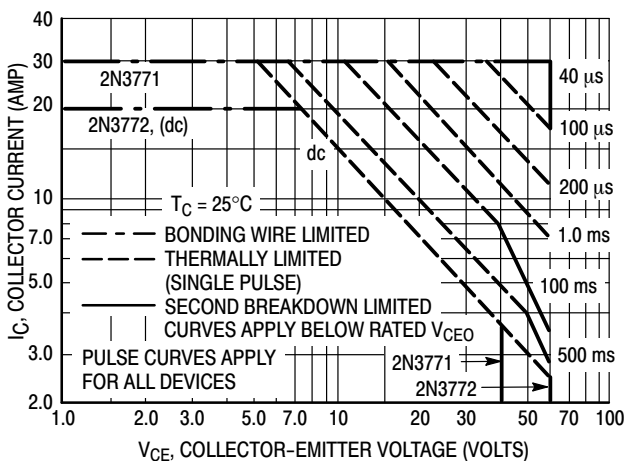

**Figure 3. Active-Region Safe Operating Area — 2N3771, 2N3772**

There are two limitations on the power handling ability of a transistor: average junction temperature and second breakdown. Safe operating area curves indicate  $I_C - V_{CE}$  limits of the transistor that must be observed for reliable operation: i.e., the transistor must not be subjected to greater dissipation than the curves indicate.

Figure 3 is based on JEDEC registered Data. Second breakdown pulse limits are valid for duty cycles to 10% provided  $T_{J(pk)} < 200^\circ\text{C}$ .  $T_{J(pk)}$  may be calculated from the data of Figure 2. Using data of Figure 2 and the pulse power limits of Figure 3,  $T_{J(pk)}$  will be found to be less than  $T_{J(max)}$  for pulse widths of 1 ms and less. When using ON Semiconductor transistors, it is permissible to increase the pulse power limits until limited by  $T_{J(max)}$ .

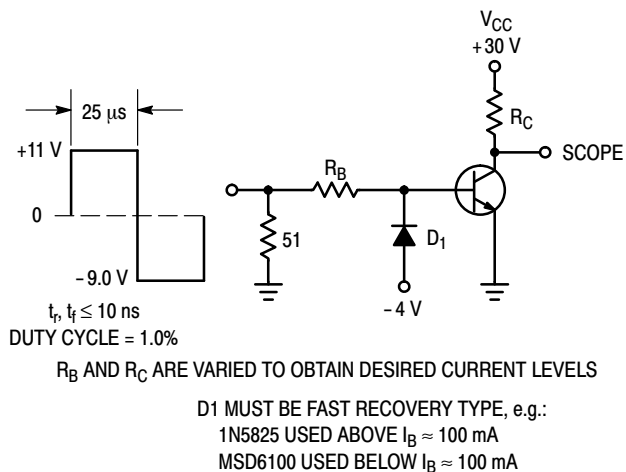

Figure 4. Switching Time Test Circuit

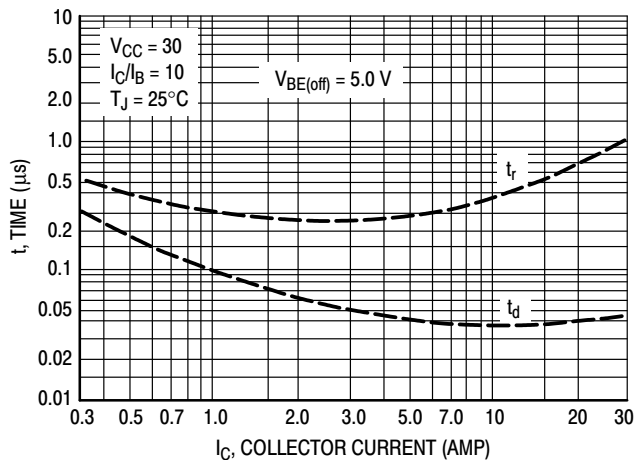

Figure 5. Turn-On Time

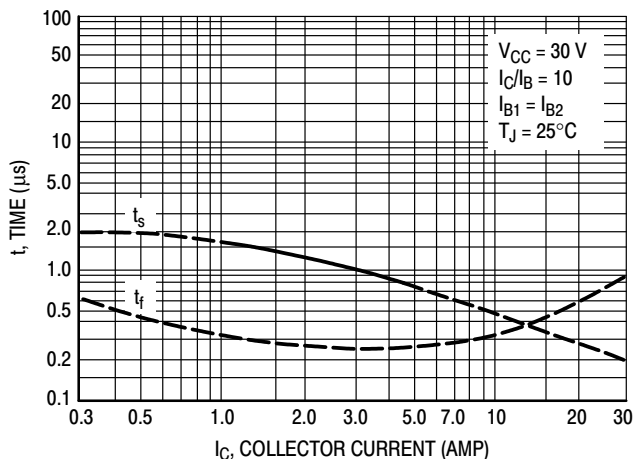

Figure 6. Turn-Off Time

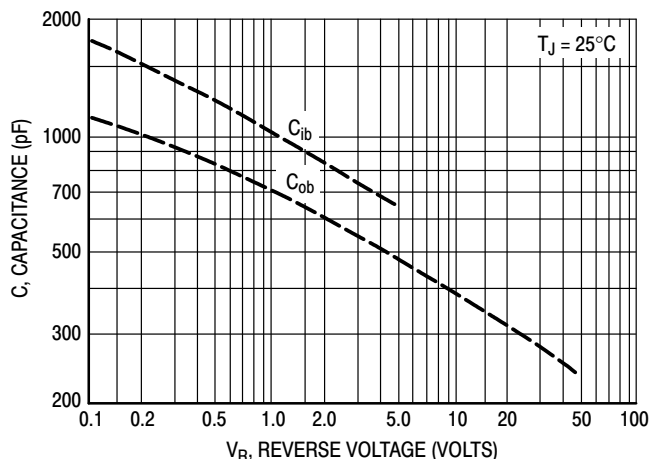

Figure 7. Capacitance

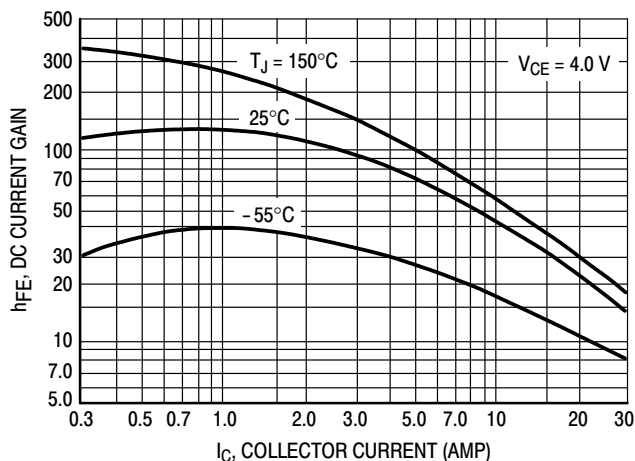

Figure 8. DC Current Gain

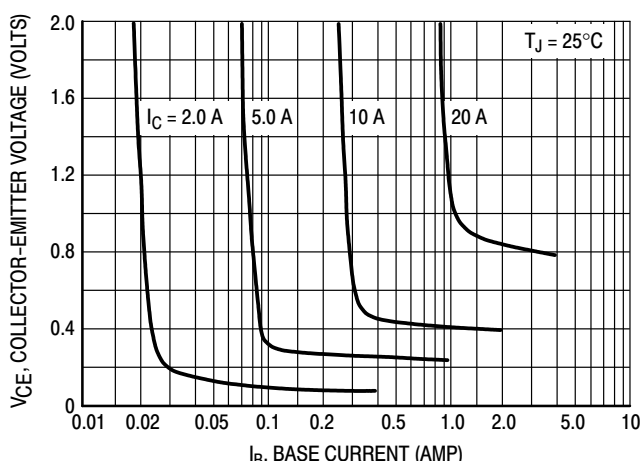

Figure 9. Collector Saturation Region

# MECHANICAL CASE OUTLINE PACKAGE DIMENSIONS



## TO-204 (TO-3) CASE 1-07 ISSUE Z

DATE 05/18/1988



SCALE 1:1



- NOTES:
1. DIMENSIONING AND TOLERANCING PER ANSI Y14.5M, 1982.
  2. CONTROLLING DIMENSION: INCH.
  3. ALL RULES AND NOTES ASSOCIATED WITH REFERENCED TO-204AA OUTLINE SHALL APPLY.

DIM	INCHES		MILLIMETERS	
	MIN	MAX	MIN	MAX
A	1.550 REF	---	39.37 REF	---
B	---	1.050	---	26.67
C	0.250	0.335	6.35	8.51
D	0.038	0.043	0.97	1.09
E	0.055	0.070	1.40	1.77
G	0.430 BSC	---	10.92 BSC	---
H	0.215 BSC	---	5.46 BSC	---
K	0.440	0.480	11.18	12.19
L	0.665 BSC	---	16.89 BSC	---
N	---	0.830	---	21.08
Q	0.151	0.165	3.84	4.19
U	1.187 BSC	---	30.15 BSC	---
V	0.131	0.188	3.33	4.77

- |  |  |   |   |   |
|--|--|---|---|---|
| <p>STYLE 1:<br/>PIN 1. BASE<br/>2. EMITTER<br/>CASE: COLLECTOR</p> | <p>STYLE 2:<br/>PIN 1. BASE<br/>2. COLLECTOR<br/>CASE: EMITTER</p> | <p>STYLE 3:<br/>PIN 1. GATE<br/>2. SOURCE<br/>CASE: DRAIN</p>           | <p>STYLE 4:<br/>PIN 1. GROUND<br/>2. INPUT<br/>CASE: OUTPUT</p>       | <p>STYLE 5:<br/>PIN 1. CATHODE<br/>2. EXTERNAL TRIP/DELAY<br/>CASE: ANODE</p> |
| <p>STYLE 6:<br/>PIN 1. GATE<br/>2. EMITTER<br/>CASE: COLLECTOR</p> | <p>STYLE 7:<br/>PIN 1. ANODE<br/>2. OPEN<br/>CASE: CATHODE</p>     | <p>STYLE 8:<br/>PIN 1. CATHODE #1<br/>2. CATHODE #2<br/>CASE: ANODE</p> | <p>STYLE 9:<br/>PIN 1. ANODE #1<br/>2. ANODE #2<br/>CASE: CATHODE</p> |   |

ON Semiconductor and are trademarks of Semiconductor Components Industries, LLC (SCILLC). SCILLC reserves the right to make changes without further notice to any products herein. SCILLC makes no warranty, representation or guarantee regarding the suitability of its products for any particular purpose, nor does SCILLC assume any liability arising out of the application or use of any product or circuit, and specifically disclaims any and all liability, including without limitation special, consequential or incidental damages. "Typical" parameters which may be provided in SCILLC data sheets and/or specifications can and do vary in different applications and actual performance may vary over time. All operating parameters, including "Typicals" must be validated for each customer application by customer's technical experts. SCILLC does not convey any license under its patent rights nor the rights of others. SCILLC products are not designed, intended, or authorized for use as components in systems intended for surgical implant into the body, or other applications intended to support or sustain life, or for any other application in which the failure of the SCILLC product could create a situation where personal injury or death may occur. Should Buyer purchase or use SCILLC products for any such unintended or unauthorized application, Buyer shall indemnify and hold SCILLC and its officers, employees, subsidiaries, affiliates, and distributors harmless against all claims, costs, damages, and expenses, and reasonable attorney fees arising out of, directly or indirectly, any claim of personal injury or death associated with such unintended or unauthorized use, even if such claim alleges that SCILLC was negligent regarding the design or manufacture of the part. SCILLC is an Equal Opportunity/Affirmative Action Employer.

ON Semiconductor and  are trademarks of Semiconductor Components Industries, LLC dba ON Semiconductor or its subsidiaries in the United States and/or other countries. ON Semiconductor owns the rights to a number of patents, trademarks, copyrights, trade secrets, and other intellectual property. A listing of ON Semiconductor's product/patent coverage may be accessed at [www.onsemi.com/site/pdf/Patent-Marking.pdf](http://www.onsemi.com/site/pdf/Patent-Marking.pdf). ON Semiconductor reserves the right to make changes without further notice to any products herein. ON Semiconductor makes no warranty, representation or guarantee regarding the suitability of its products for any particular purpose, nor does ON Semiconductor assume any liability arising out of the application or use of any product or circuit, and specifically disclaims any and all liability, including without limitation special, consequential or incidental damages. Buyer is responsible for its products and applications using ON Semiconductor products, including compliance with all laws, regulations and safety requirements or standards, regardless of any support or applications information provided by ON Semiconductor. "Typical" parameters which may be provided in ON Semiconductor data sheets and/or specifications can and do vary in different applications and actual performance may vary over time. All operating parameters, including "Typicals" must be validated for each customer application by customer's technical experts. ON Semiconductor does not convey any license under its patent rights nor the rights of others. ON Semiconductor products are not designed, intended, or authorized for use as a critical component in life support systems or any FDA Class 3 medical devices or medical devices with a same or similar classification in a foreign jurisdiction or any devices intended for implantation in the human body. Should Buyer purchase or use ON Semiconductor products for any such unintended or unauthorized application, Buyer shall indemnify and hold ON Semiconductor and its officers, employees, subsidiaries, affiliates, and distributors harmless against all claims, costs, damages, and expenses, and reasonable attorney fees arising out of, directly or indirectly, any claim of personal injury or death associated with such unintended or unauthorized use, even if such claim alleges that ON Semiconductor was negligent regarding the design or manufacture of the part. ON Semiconductor is an Equal Opportunity/Affirmative Action Employer. This literature is subject to all applicable copyright laws and is not for resale in any manner.

## PUBLICATION ORDERING INFORMATION

### LITERATURE FULFILLMENT:

Email Requests to: [orderlit@onsemi.com](mailto:orderlit@onsemi.com)

ON Semiconductor Website: [www.onsemi.com](http://www.onsemi.com)

### TECHNICAL SUPPORT

North American Technical Support:  
Voice Mail: 1 800-282-9855 Toll Free USA/Canada  
Phone: 011 421 33 790 2910

### Europe, Middle East and Africa Technical Support:

Phone: 00421 33 790 2910

For additional information, please contact your local Sales Representative