

SURFACE MOUNT (SMT) & THRU HOLE (THM) BUTTON CELL RETAINERS

Economical and reliable SMT and THM coin cell retainers specifically designed for miniature electronic applications with limited board space.

- Available in Thru Hole Mount (THM) or Surface Mount (SMT) configurations
- Retains battery securely to withstand shock and vibration
- THM legs maintain relative position during and after soldering
- Ideally suited for High Density packaging
- Reliable spring tension assures low contact resistance
- SMT solder tail with "flow-hole" design for increased joint strength
- Solder tail located outside of retainer body which facilitates visual inspection of the solder joints

4.8mm to 10mm BUTTON CELL RETAINERS

AVAILABLE ON TAPE AND REEL

4.8mm



Surface Mount

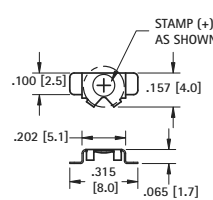

STAMP (+) AS SHOWN

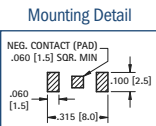

Mounting Detail

MATERIAL: .006 (.15) Phosphor Bronze, Gold Plate (Flash)

CAT. NO. BULK	ON TAPE & REEL	BATTERY REFERENCE
2994	2994TR	ML414

Tape & Reel Spec's: 16mm wide; 8mm pitch; 13 inch reel (1500 pieces per reel)



Thru Hole Mount

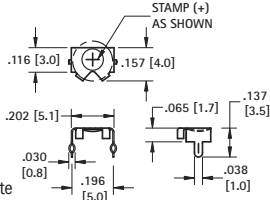

STAMP (+) AS SHOWN

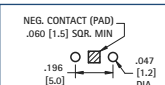

Mounting Detail

MATERIAL: .006 (.15) Phosphor Bronze, Tin-Nickel Plate

CAT. NO.	BATTERY REFERENCE
2995	ML414

AVAILABLE ON TAPE AND REEL

5.8mm



Surface Mount

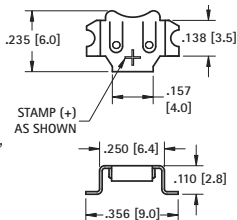

STAMP (+) AS SHOWN

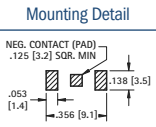

Mounting Detail

MATERIAL: .006 (.15) Phosphor Bronze, Tin-Nickel Plate

CAT. NO. BULK	ON TAPE & REEL	BATTERY REFERENCE
2986	2986TR	379, 317

Tape & Reel Spec's: 16mm wide; 8mm pitch; 13 inch reel (1500 pieces per reel)



Thru Hole Mount

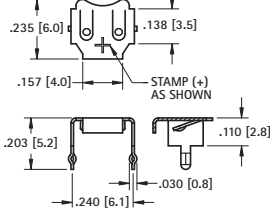

STAMP (+) AS SHOWN

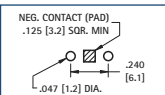

Mounting Detail

MATERIAL: .006 (.15) Phosphor Bronze, Tin-Nickel Plate

CAT. NO.	BATTERY REFERENCE
2987	379, 317

AVAILABLE ON TAPE AND REEL

6.8mm



Surface Mount

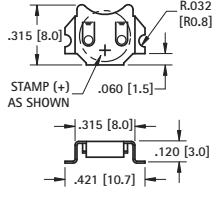

STAMP (+) AS SHOWN

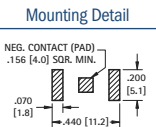

Mounting Detail

MATERIAL: .010 (.25) Phosphor Bronze

CAT. NO. BULK	ON TAPE & REEL	FINISH	BATTERY REFERENCE
2998	2998TR	Tin-Nickel	MC621, V364, SC621, DR13H,
3098	3098TR	Matte Tin	DR77, V13AT, 377

Tape & Reel Spec's: 24mm wide; 12mm pitch; 13 inch reel (1000 pieces per reel)



Thru Hole Mount

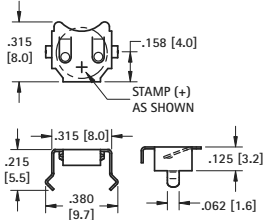

STAMP (+) AS SHOWN

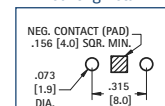

Mounting Detail

MATERIAL: .010 (.25) Phosphor Bronze, Tin-Nickel Plate

CAT. NO.	BATTERY REFERENCE
2999	MC621, V364, SC621, DR13H, DR77, V13AT, 377

AVAILABLE ON TAPE AND REEL

7.9mm



Surface Mount

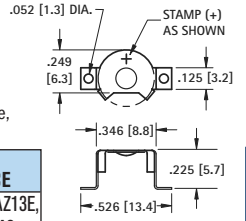

STAMP (+) AS SHOWN

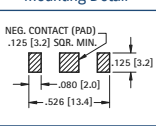

Mounting Detail

MATERIAL: .010 (.25) Phosphor Bronze, Gold Plate (Flash)

CAT. NO. BULK	ON TAPE & REEL	BATTERY REFERENCE
2988	2988TR	Size 13, DA13, AZ13E, 393, SR754, SR48

Tape & Reel Spec's: 24mm wide; 12mm pitch; 13 inch reel (800 pieces per reel)



Thru Hole Mount

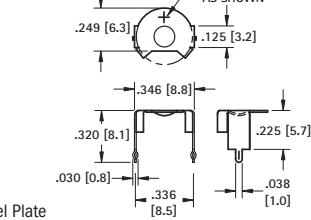

STAMP (+) AS SHOWN

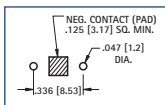

Mounting Detail

MATERIAL: .010 (.25) Phosphor Bronze, Tin-Nickel Plate

CAT. NO.	BATTERY REFERENCE
2989	Size 13, DA13, AZ13E, 393, SR754, SR48

AVAILABLE ON TAPE AND REEL

9 - 10mm



Surface Mount

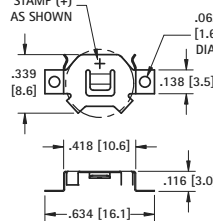

STAMP (+) AS SHOWN

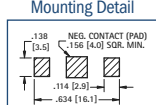

Mounting Detail

MATERIAL: .006 (.15) Phosphor Bronze, Tin-Nickel Plate

CAT. NO. BULK	ON TAPE & REEL	FINISH	BATTERY REFERENCE
3030	3030TR	Tin-Nickel	CR927, CR1025
3050	3050TR	Matte Tin	

Tape & Reel Spec's: 24mm wide; 12mm pitch; 13 inch reel (1500 pieces per reel)



Thru Hole Mount

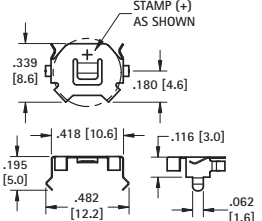

STAMP (+) AS SHOWN

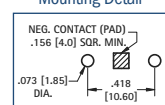

Mounting Detail

MATERIAL: .006 (.15) Phosphor Bronze, Tin-Nickel Plate

CAT. NO.	BATTERY REFERENCE
3031	CR927, CR1025

LOCKING COIN CELL RETAINERS

- Coin cell is secured even in shock & vibration applications
- Battery can be removed without use of tools

- Compatible with all wave and reflow soldering processes
- Tin-Nickel plating is ideal for High temperature, lead free, soldering

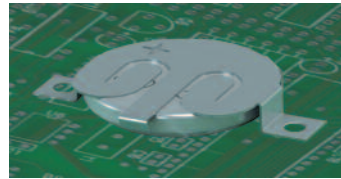
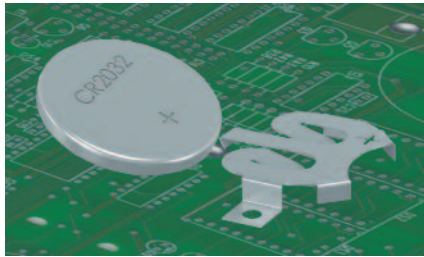

Toolless Battery installation:

1. Tilt battery so that top edge of battery will slide under retaining tab.
2. Level battery and slide into retainer until retaining tab snaps over battery.

Locking Retainer:

Battery will stay retained even in severe shock applications such as hand held devices. Battery can be removed by lifting retaining tab and pushing battery from back end of retainer.

SMT

THM

- Flow hole solder tail designed for increased joint strength
- Compatible with most vacuum and mechanical pick and place assembly systems
- All conductive polystyrene carrier tape meets ANSI/EIA-481 standard

- Snap-In legs will maintain positioning prior and during soldering
- Compatible with wave solder application

MATERIAL: .010 (.25) Phosphor Bronze, Tin-Nickel Plate



Surface Mount

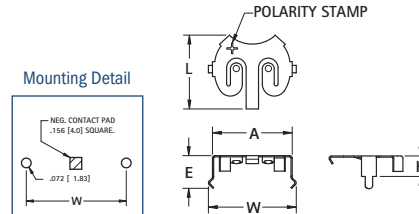
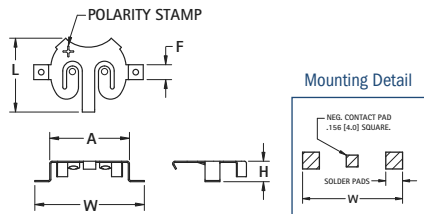

Thru Hole Mount

AVAILABLE ON TAPE AND REEL

Surface Mount									Thru Hole Mount	
CAT. NO.	ON TAPE & REEL	A	H	L	W	CELL DIA.	BATTERY REFERENCE	CAT. NO.	BULK	
2894	2984TR	.520 (13.2)	.106 (2.7)	.494 (12.5)	.700 (17.8)	12mm	CR1220	2895		
2896	2986TR	.670 (17.0)	.171 (4.3)	.620 (15.8)	.920 (23.4)	16mm	BR1632	2897		
2898	2988TR	.830 (21.1)	.171 (4.3)	.771 (19.6)	1.210 (30.7)	20mm	CR2032	2899		

SURFACE MOUNT (SMT) & THRU-HOLE (THM) INSULATED RETAINERS



Surface Mount

20mm CELLS

- Ideal for 6 volt or 3 volt applications
- Two coin cell batteries can be installed in series
- Plastic insulator prevents shorting of battery, within the holder, when installed improperly
- Low profile
- Battery release ports for easy battery replacement
- Refer to pages 8 & 11 for a complete offering of coin cell retainers

MATERIAL: Contacts: .010 (.25) Phosphor Bronze Insulator: High Temperature, Nylon 46, UL Rated 94V-0



Thru Hole Mount

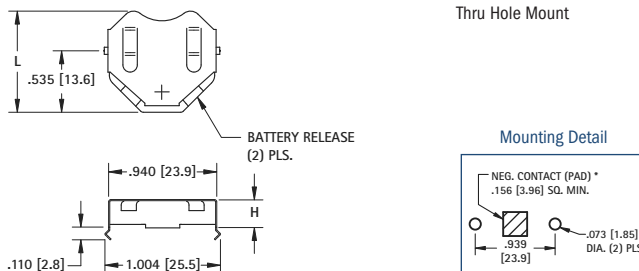
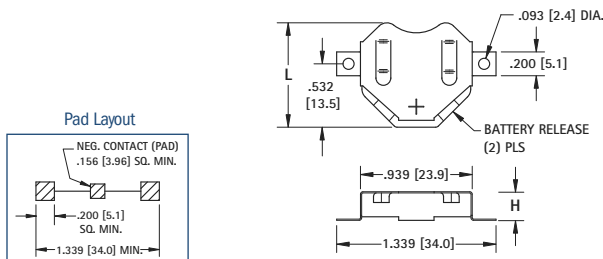

AVAILABLE ON TAPE AND REEL

Surface Mount						BATTERY REFERENCE				Thru Hole Mount	
Tin-Nickel Plate			Matte Tin Plate			6 VOLT (2) CELLS		3 VOLT (1) CELL		Tin-Nickel Plate	
CAT. NO.	CAT. NO.	ON TAPE & REEL	CAT. NO.	CAT. NO.	ON TAPE & REEL	L	H	L	H	CAT. NO.	CAT. NO.
3020-2	3020	3020TR	3070-2	3070	3070TR	.890 (22.6)	.156 (4.0)	2012, 2016	2020, 2025	.890 (22.6)	.156 (4.0)
3022-2	3022	3022TR	3072-2	3072	3072TR	.877 (22.3)	.240 (6.1)	2020, 2025	2032	.877 (22.3)	.240 (6.1)
3024-2	3024	3024TR	3074-2	3074	3074TR	.877 (22.3)	.295 (7.5)	2032	Not Applicable	.877 (22.3)	.295 (7.5)

* Supplied Unassembled

Tape & Reel Specs: 56mm wide; 28mm pitch; 13 inch reel: **3020TR, 3070TR** 400 pieces per reel; **3022TR, 3072TR** 250 pieces per reel; **3024TR, 3074TR** 250 pieces per reel

THRU HOLE (THM) COIN CELL RETAINERS

11.6mm to 30mm COIN CELL RETAINERS



- Snap-In legs maintain relative positioning prior and during soldering
- Compatible with wave soldering processes
- Thru hole solder legs provides excellent mechanical strength
- Lowest profile mounting as compared to coin cell holders
- Economical design allows for PCB pads to be used as negative contacts
- Tin Nickel plating provides low contact resistance and will hold up to high temperature lead free soldering
- Battery can be easily replaced without any tools

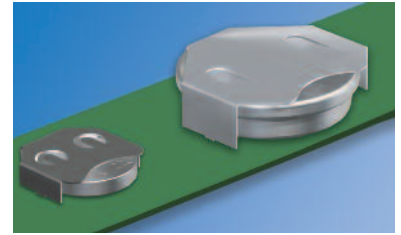

MATERIAL: .010 (.25) Phosphor Bronze, Tin-Nickel Plate

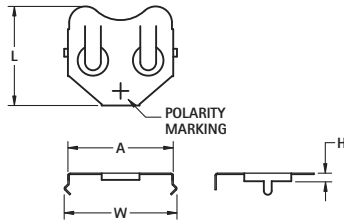
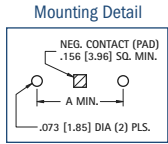

FIG. 1 - Compact

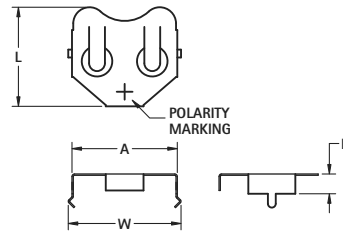
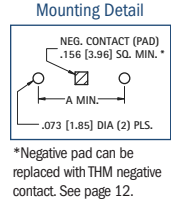

FIG. 2 - Low Profile



CAT. NO.	FIG.	A	H	L	W	CELL DIA.	BATTERY REFERENCE
2997	2	.520 (13.2)	.235 (6.0)	.475 (12.1)	.585 (14.9)	11.6mm	SR43, 186, 386, A76, LR44, 357, MS76, PX76A, G-13, 303, V313
3001	2	.520 (13.2)	.118 (3.0)	.475 (12.1)	.585 (14.9)	12mm	CR1216, BR1220, CL1225, SR1120, D381, 391, 191
3013	2	.664 (16.9)	.156 (4.0)	.594 (15.1)	.723 (18.4)	16mm	BR1616, CR1612, CR1616, CR1620, CR1632
3027	1	.831 (21.1)	.085 (2.2)	.782 (19.9)	.890 (22.6)	20mm	BR2016, CR2016, DL2016
3003	2	.831 (21.1)	.156 (4.0)	.782 (19.9)	.890 (22.6)	20mm	BR2320, CL2330, CR2320, BR2325, CR2325, DL2325
3005	2	.939 (23.9)	.156 (4.0)	.832 (21.1)	1.004 (25.5)	23mm	BR2320, CL2330, CR2320, BR2325, CR2325, DL2325
3011	2	.939 (23.9)	.240 (6.1)	.819 (20.8)	1.004 (25.5)	23mm	CR2354, DL2354
3007	1	1.000 (25.4)	.156 (4.0)	.918 (23.3)	1.055 (26.8)	24mm	CR2430, DL2430
3009	2	1.000 (25.4)	.230 (5.8)	.890 (22.6)	1.059 (26.9)	24mm	CR2450, DL2450
3039	2	1.000 (25.4)	.336 (8.5)	.890 (22.6)	1.059 (26.9)	24mm	CR2477, DL2477
3047	2	1.227 (31.2)	.167 (4.2)	1.020 (25.9)	1.340 (34.0)	30mm	CR3032

THRU HOLE (THM) ULTRA LOW PROFILE COIN CELL RETAINER



The Ultra Low Profile Coin Cell retainers are designed specifically for the most popular 20mm & 24mm coin cells. It will provide reliable contact as well as retain the coin cell with the minimum space needed. Ideal for small applications such as remote controls or active RFID tags.

- Slim design - saves valuable board space
- Narrow face allows for quick and easy battery replacement
- Designed for specific batteries - lowest height design

MATERIAL: .010 (.25) Phosphor Bronze, Tin-Nickel Plate

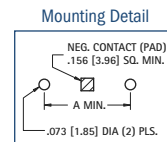
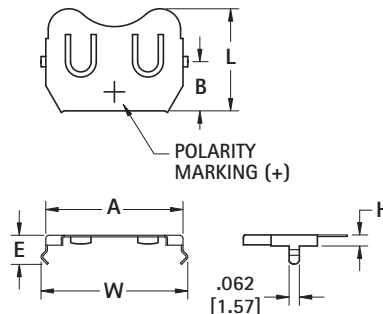

CAT. NO.	A	H	L	W	CELL DIA.	BATTERY REFERENCE
3029	.831 (21.1)	.067 (1.7)	.618 (15.7)	.890 (22.6)	20mm	CR2012, DL2012
3035*	.835 (21.2)	.170 (4.3)	.600 (15.2)	.880 (22.3)	20mm	CR2032 also CR2025, CR2020
3033	1.000 (25.4)	.067 (1.7)	.681 (17.3)	1.055 (26.8)	24mm	CR2412, BR2412

* Nickel Plate

SURFACE MOUNT (SMT) COIN CELL RETAINERS

- Compatible with reflow soldering processes
- Solder tails located outside of retainer which facilitates visual inspection of solder joint
- Compatible with most vacuum and mechanical pick & place assembly system
- All conductive carrier tape meets ANSA/EIA-481 standards
- Economical design allows for PCB pads to be used as negative contacts
- Matte Tin Plate for lower soldering temperatures. Ideal when other temperature sensitive components are being used

- Tin Nickel plating provides low contact resistance and will hold up to high temperature lead free soldering
- Dual spring contact assures battery will have proper contact with PCB
- Battery can be easily replaced without any tools

SURFACE MOUNT (SMT)

AVAILABLE ON TAPE AND REEL

- All conductive polystyrene carrier tape meets ANSI/EIA-481 standards

MATERIAL: .010 (.25) Phosphor Bronze

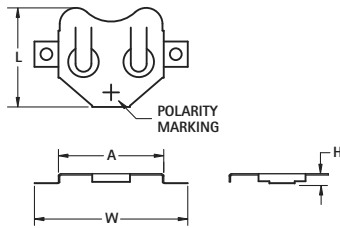
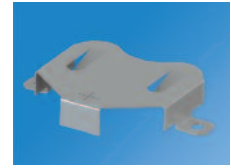
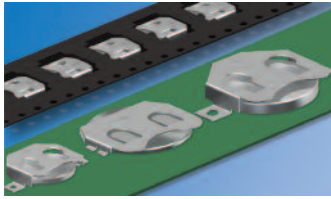
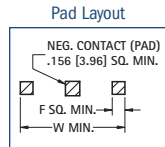
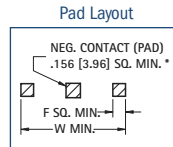

FIG. 1 - Compact



*SMT negative contact pads not recommended for compact retainers.



*Negative pad can be replaced with SMT negative contact. See page 12.

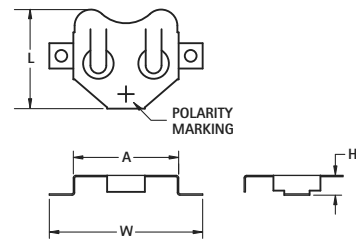

FIG. 2 - Low Profile

TIN-NICKEL PLATE		MATTE TIN PLATE		FIG.	A	H	L	W	CELL DIA.	BATTERY REFERENCE	TAPE & REEL SPEC'S
CAT. NO. BULK	ON TAPE & REEL	CAT. NO. BULK	ON TAPE & REEL								
2996	2996TR	3096	3096TR	2	.520 (13.2)	.235 (6.0)	.475 (12.1)	.700 (17.8)	11.6mm	SR43, 186, 386, A76, LR44, 357, MS76, PX76A, G-13, 303, V313	32mm wide; 16mm pitch; 600/reel
3000	3000TR	3080	3080TR	2	.520 (13.2)	.125 (3.2)	.475 (12.1)	.745 (18.9)	12mm	CR1216, BR1220, CL1225, SR1120, D381, 391, 191	32mm wide; 16mm pitch; 1000/reel
3012	3012TR	3092	3092TR	2	.664 (16.9)	.156 (4.0)	.594 (15.1)	.914 (23.2)	16mm	BR1612, CR1616, CR1620, DL1632	44mm wide; 24mm pitch; 600/reel
3026	3026TR	3078	3078TR	1	.831 (21.1)	.085 (2.2)	.782 (19.9)	1.210 (30.7)	20mm	BR2016, CR2016, DL2016	44mm wide; 24mm pitch; 1000/reel
3002	3002TR	3082	3082TR	2	.831 (21.1)	.156 (4.0)	.782 (19.9)	1.210 (30.7)	20mm	BR2016, DL2020, CR2025, CR2032	44mm wide; 24mm pitch; 500/reel
3004	3004TR	3084	3084TR	2	.939 (23.9)	.156 (4.0)	.832 (21.1)	1.339 (34.0)	23mm	BR2320, CL2325, CR2330, DL2335	56mm wide; 32mm pitch; 400/reel
3010	3010TR	3090	3090TR	2	.939 (23.9)	.240 (6.1)	.819 (20.8)	1.339 (34.0)	23mm	CR2354, DL2354	56mm wide; 32mm pitch; 200/reel
3006	3006TR	3086	3086TR	1	1.000 (25.4)	.156 (4.0)	.918 (23.3)	1.400 (35.6)	24mm	CR2430, DL2430	56mm wide; 32mm pitch; 400/reel
3008	3008TR	3088	3088TR	2	1.000 (25.4)	.230 (5.8)	.890 (22.6)	1.400 (35.6)	24mm	CR2450, DL2450	56mm wide; 32mm pitch; 200/reel
3046	3046TR	—	—	2	1.227 (14.3)	.167 (4.2)	1.020 (25.9)	1.627 (41.3)	30mm	CR3032	56mm wide; 32mm pitch; 400/reel

SURFACE MOUNT (SMT) ULTRA LOW PROFILE COIN CELL RETAINER



AVAILABLE ON TAPE AND REEL

Ultra Low Profile Coin Cell Retainers are designed specifically for the most popular coin cells. It will provide reliable contact as well as retain the coin cell with the minimum space needed. Ideal for small applications such as remote controls or active RFID tags.

- Slim design - saves valuable board space
- Narrow face allows for quick and easy battery replacement
- Designed for specific batteries - lowest height design

MATERIAL: .010 (.25) Phosphor Bronze, Tin-Nickel Plate

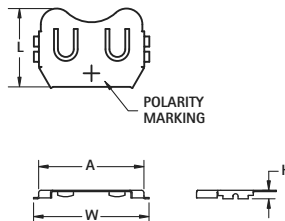
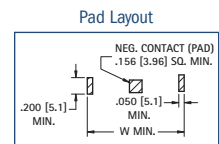

FIG. 3 - Ultra Low



*SMT negative contact pads not recommended for Ultra Low Profile retainers.

TIN-NICKEL PLATE		MATTE TIN PLATE		FIG.	A	H	L	W	CELL DIA.	BATTERY REFERENCE	TAPE & REEL SPEC'S
CAT. NO. BULK	ON TAPE & REEL	CAT. NO. BULK	ON TAPE & REEL								
3028	3028TR	3038	3038TR	3	.831 (21.1)	.067 (1.7)	.618 (15.7)	.911 (23.1)	20mm	BR2012, CR2012, DL2012	44mm wide; 24mm pitch; 1000/reel
3034*	3034TR*	3044*	3044TR*	3	.835 (21.2)	.160 (4.1)	.635 (16.1)	0.915 (23.1)	20mm	BR2016, DL2020, CR2025, CR2032	44mm wide; 24mm pitch; 1000/reel
3032	3032TR	3042	3042TR	3	1.000 (25.4)	.067 (1.7)	.681 (17.3)	1.080 (27.4)	24mm	BR2412, CR2412	44mm wide, 24mm pitch, 1000/reel

*Nickel Plate

SURFACE MOUNT (SMT) COIN CELL ENCLOSURE CONTACTS

- Contacts for Enclosure cases with self contained battery compartments
- Design facilitates easy battery access, removal & installation

- Suitable for industrial and consumer product applications
- Spring contacts adjust to variations in battery diameter for a dependable connection

- Positive and Negative contacts can be used as a design pair or individually on a PCB
- Accommodates cell diameters from 12mm to 30mm

AVAILABLE ON TAPE AND REEL

MATERIAL: .006 (.15) Stainless Steel, Gold Plate (Flash)

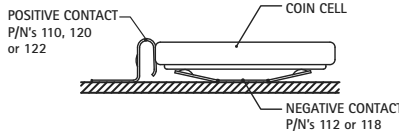
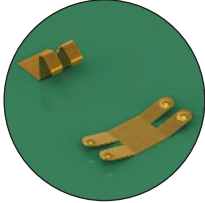

Refer to page 38 for Mounting Details

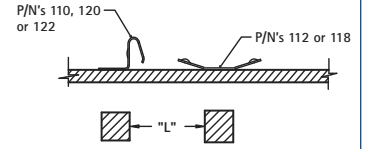

CONTACT SELECTION GUIDE

BATTERY DIAMETER	BATTERY REFERENCE	CAT. NO. REFERENCE	MOUNTING DETAIL
Accommodates 12mm to 16mm	CR1212, CR1216, CR1220, CR1612, CR1616, CR1620	120 (Pos) & 118 (Neg)	See page 38
	CR1225, CR1625, CR1632	110 (Pos) & 118 (Neg)	See page 38
Accommodates 20mm to 30mm	CR2012, CR2016, CR2020, CR2320, CR2412	120 (Pos) & 112 (Neg)	See page 38
	CR2025, CR2032, CR2325, CR2330, CR2430, CR3032	110 (Pos) & 112 (Neg)	See page 38
	CR2050, CR2335, CR2354, CR2430, CR2440, CR2450, CR2477, CR3048	122 (Pos) & 112 (Neg)	See page 38

12mm to 30mm COIN CELL CONTACTS

POSITIVE

LOW BATTERY HEIGHT
1.2mm to 2.0mm

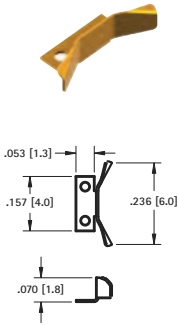

CAT. NO. 120 Bulk

CAT. NO. 120TR Tape & Reel

Tape & Reel Spec's: 16mm wide, 8mm pitch, 13 inch reel, 3000 pieces per reel

MEDIUM BATTERY HEIGHT
2.0mm to 3.2mm

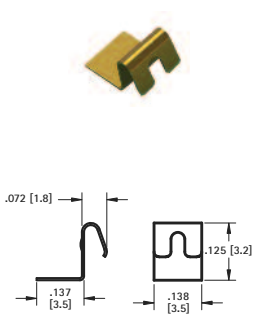

CAT. NO. 110 Bulk

CAT. NO. 110TR Tape & Reel

Tape & Reel Spec's: 16mm wide, 8mm pitch, 13 inch reel, 2000 pieces per reel

TALL BATTERY HEIGHT
3.5mm to 7.7mm

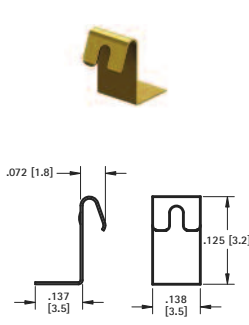

CAT. NO. 122 Bulk

CAT. NO. 122TR Tape & Reel

Tape & Reel Spec's: 16mm wide, 8mm pitch, 13 inch reel, 1000 pieces per reel

NEGATIVE

BATTERY DIAMETER
12mm to 16mm

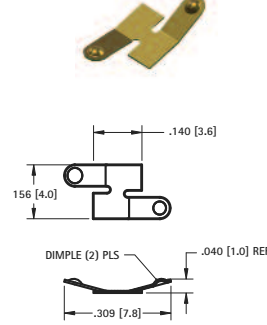

CAT. NO. 118 Bulk

CAT. NO. 118TR Tape & Reel

Tape & Reel Spec's: 24mm wide, 8mm pitch, 13 inch reel, 5000 pieces per reel

BATTERY DIAMETER
20mm to 30mm

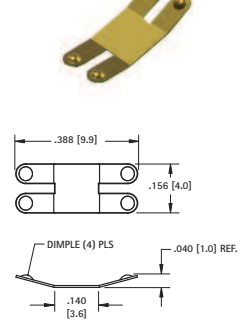

CAT. NO. 112 Bulk

CAT. NO. 112TR Tape & Reel

Tape & Reel Spec's: 24mm wide, 8mm pitch, 13 inch reel, 5000 pieces per reel

SURFACE MOUNT (SMT) & THRU-HOLE (THM) NEGATIVE BATTERY CONTACTS

AVAILABLE ON TAPE AND REEL



- Assures proper contact

Pad Layout

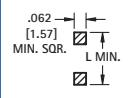

SMT COMPACT*

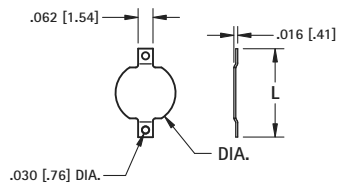

DWG. 1 MATERIAL: .008 (.20) Brass



- Assures proper contact

Pad Layout

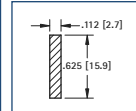

SMT SPRING CONTACT*

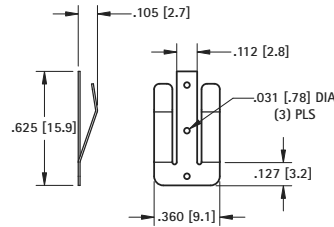

DWG. 2 MATERIAL: .010 (.25) Phosphor Bronze

THM SNAP IN*



- Assures proper contact

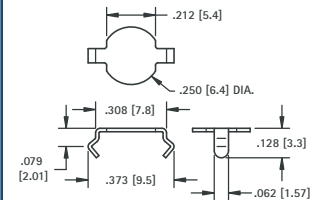

MATERIAL: .008 (.20) Phosphor Bronze, Tin-Nickel Plate

CAT. NO. 2990

Mounting Detail

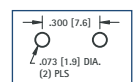

TIN-NICKEL PLATE		MATTE TIN PLATE		DWG.	L	DIA.	TAPE & REEL SPECS
CAT. NO. BULK	ON TAPE & REEL	CAT. NO. BULK	ON TAPE & REEL				
2991	2991TR	2981	2981TR	1	.368 (9.4)	.250 (6.4)	16mm wide, 8mm pitch, 1500/7 reel
2992	2992TR	2982	2982TR	1	.289 (7.4)	.186 (4.7)	16mm wide, 12mm pitch, 1000/7 reel
2993	2993TR	2983	2983TR	2	.625 (15.9)	-	24mm wide, 16mm pitch, 1000/13 reel

*Note: Cannot be used with Cat. No. 3028, 3029, 3032, 3038, 3042, 3026, 3078.