

LOC		DIST		REVISIONS			
P	LTN	DESCRIPTION	DATE	DWN	APVD		
D4		REVISED PER ECO-19-018884	12DEC2019	WLS	DZ		
D5		REVISED PER ECN-21-107394	01JUL2021	WLS	VS		

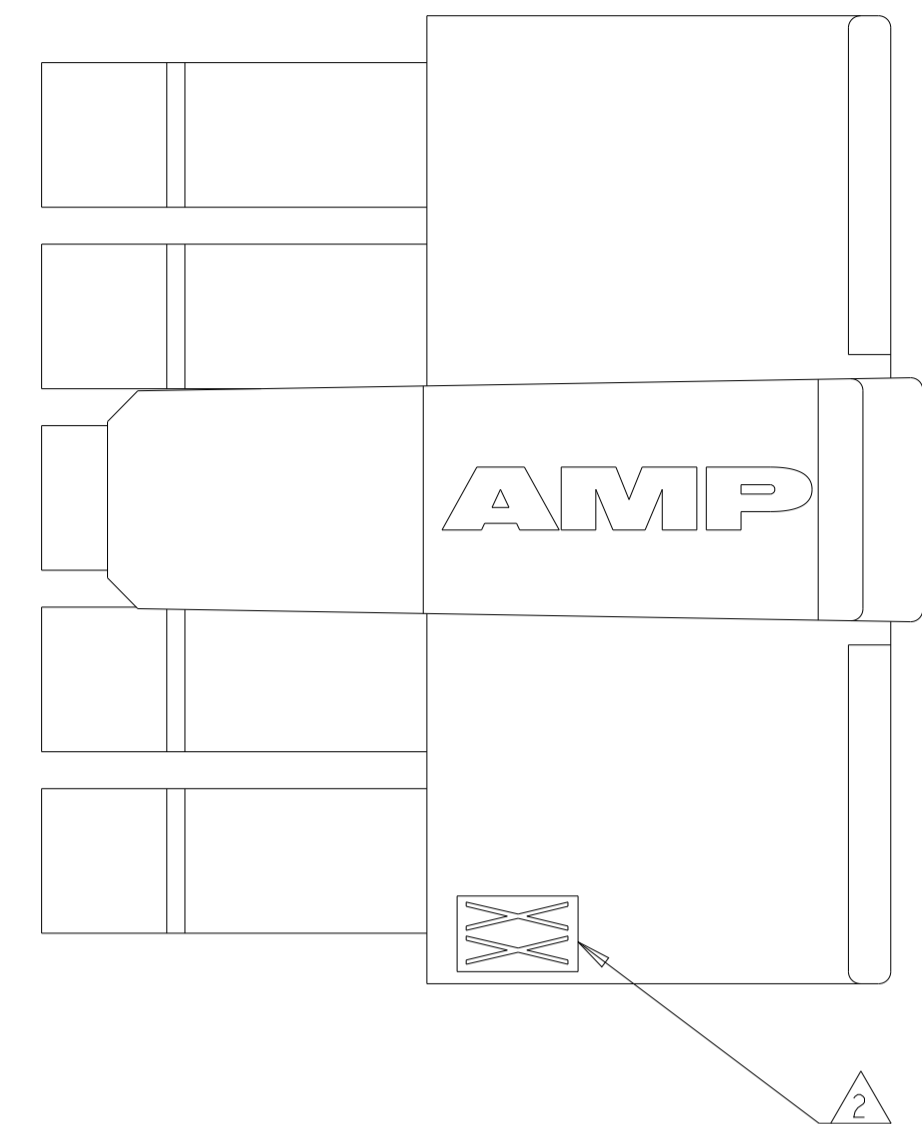

- △ 1 CIRCUIT 1 IDENTIFIER, LOCATED APPROXIMATELY AS SHOWN.
- △ 2 LAST CIRCUIT IDENTIFIER, LOCATED APPROXIMATELY AS SHOWN.
- △ 3 MATERIAL PA66/6 UL94-V0. COLOR - BLACK
- △ 4 PRELIMINARY MATERIAL PA66 UL94-V0 GW. COLOR - NATURAL
- △ 5 MATERIAL ID ">PA<" LOCATED IN APPROX AREA SHOWN, APPROX 0.01 HIGH.
- △ 6 PRELIMINARY PART NUMBER NOT RELEASED FOR PRODUCTION

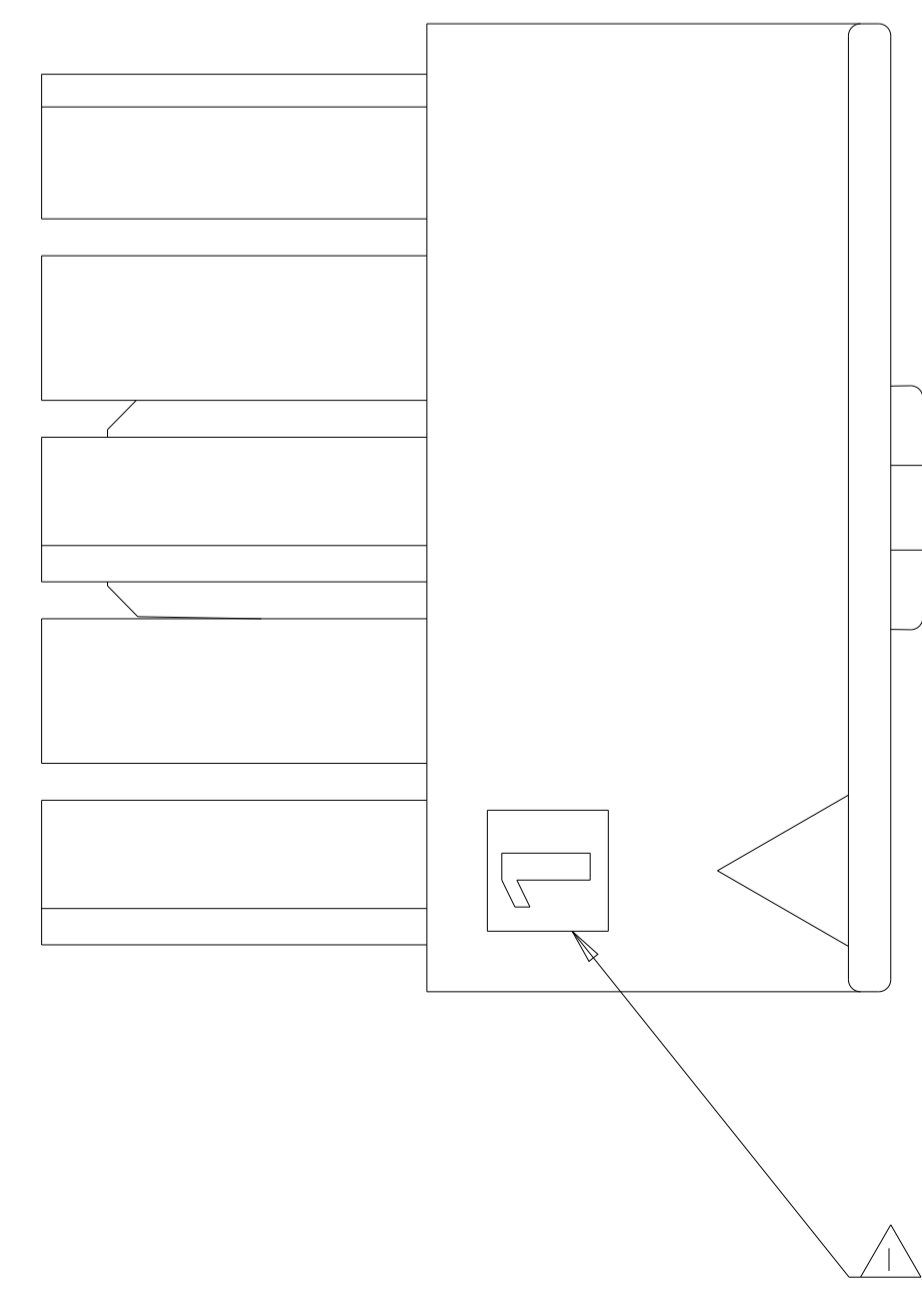
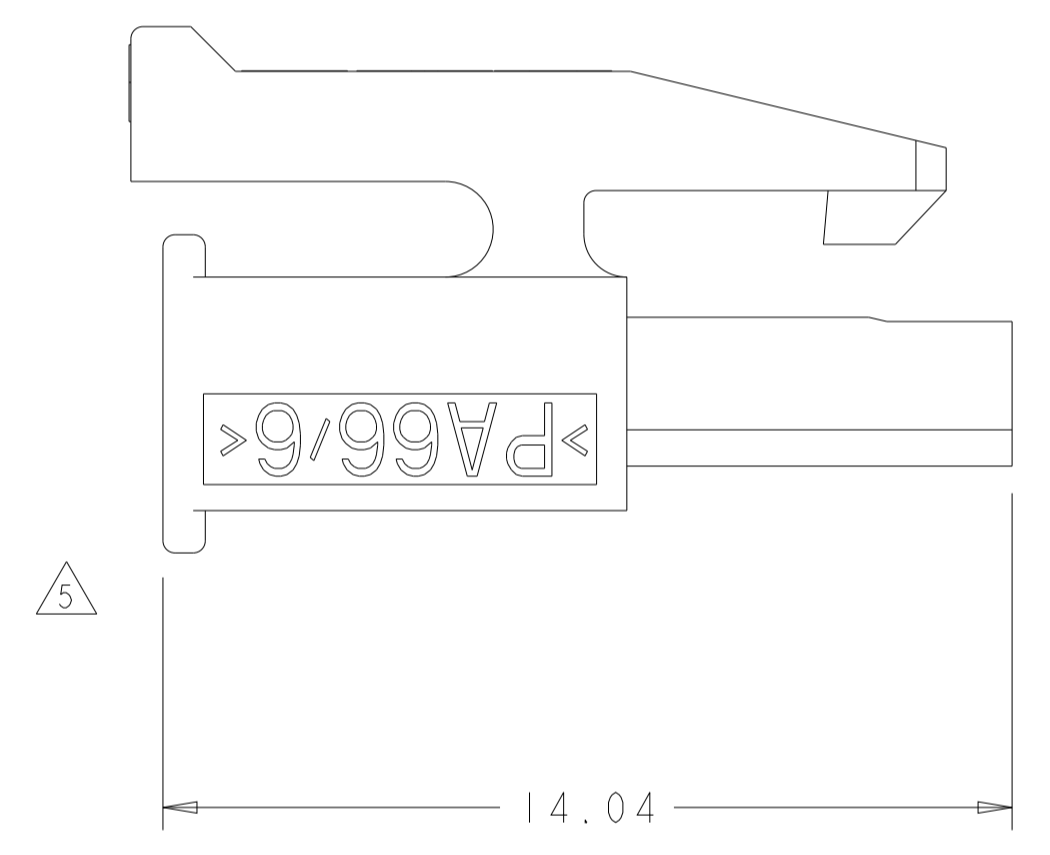
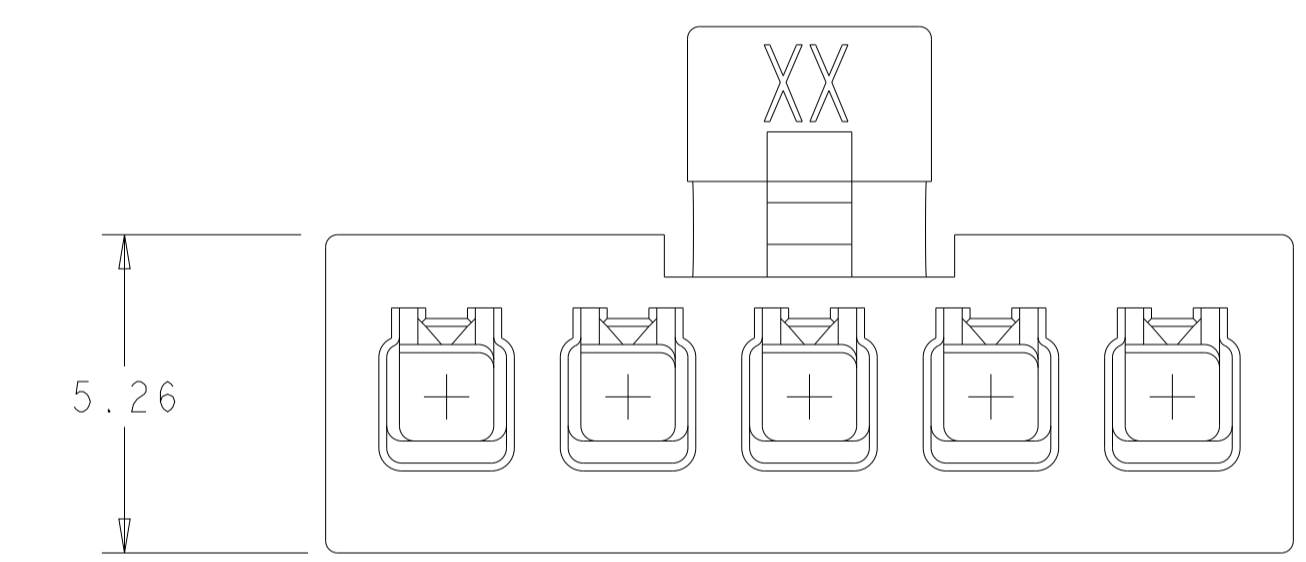
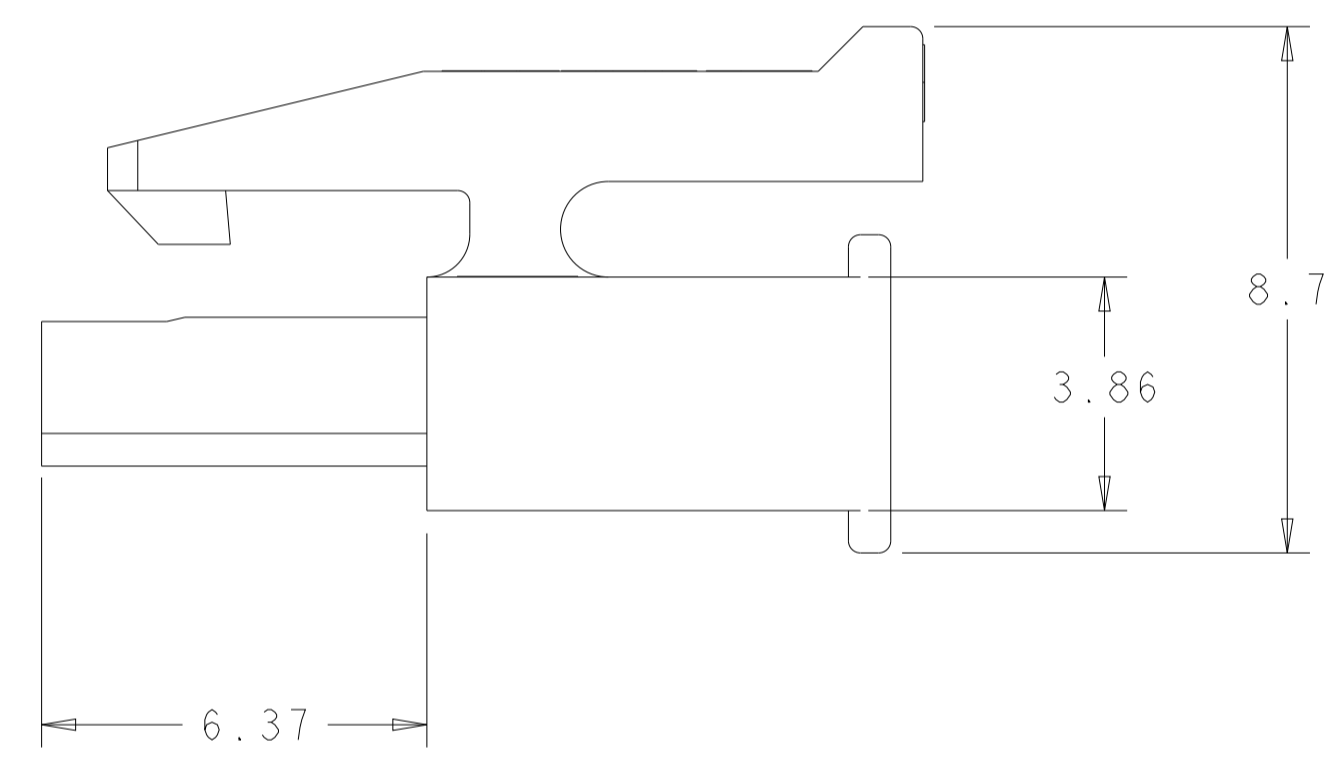
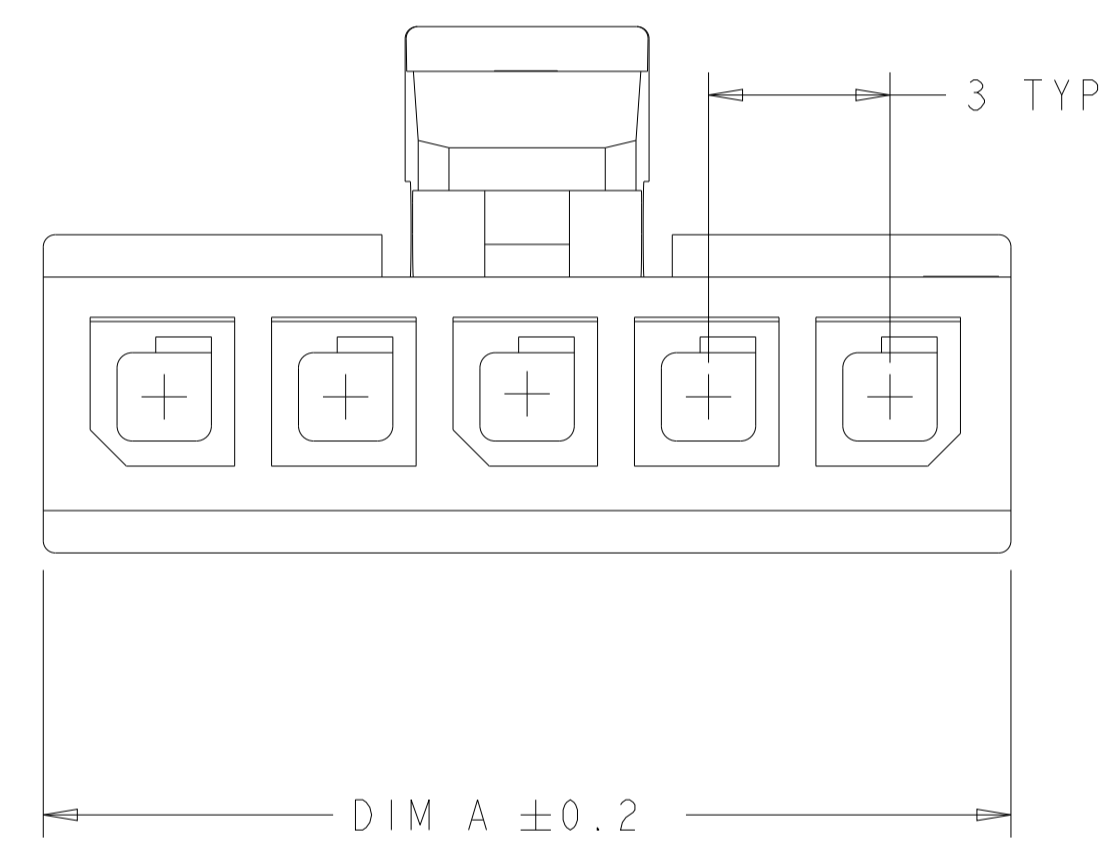

OBSOLETE	-19	6	△ 2-1445022-6/△ 6
OBSOLETE	-16	5	△ 2-1445022-5/△ 6
OBSOLETE	-13	4	2-1445022-4
OBSOLETE	-10	3	△ 2-1445022-3/△ 6
OBSOLETE	-7	2	2-1445022-2
	37	12	1-1445022-2
	34	11	1-1445022-1
	31	10	1-1445022-0
	28	9	1445022-9
	25	8	1445022-8
	22	7	1445022-7
	19	6	1445022-6
	16	5	1445022-5
	13	4	1445022-4
	10	3	1445022-3
	7	2	1445022-2
REMARK	DIM A	NO OF POS.	PART NO.

THIS DRAWING IS A CONTROLLED DOCUMENT.

DWN: R. WHITAKER 14AUG2001
 CHK: C. JONES 14AUG2001
 APVD: C. JONES 14AUG2001

STE TE Connectivity

RECEPTACLE HOUSING, 2 TO 12 POSITION, SINGLE ROW, MICRO MATE-L-LOK(TM)

SIZE: A1 CAGE CODE: 100779 DRAWING NO: 1445022

SCALE: 8:1 SHEET 1 OF 1 REV: D5

Mouser Electronics

Authorized Distributor

Click to View Pricing, Inventory, Delivery & Lifecycle Information:

[TE Connectivity:](#)

[1445022-4](#)