

Data sheet | Item number: 281-652

4-conductor through terminal block; 4 mm²; center marking; for DIN-rail 35 x 15 and 35 x 7.5; CAGE CLAMP®; 4,00 mm²; gray

<https://www.wago.com/281-652>

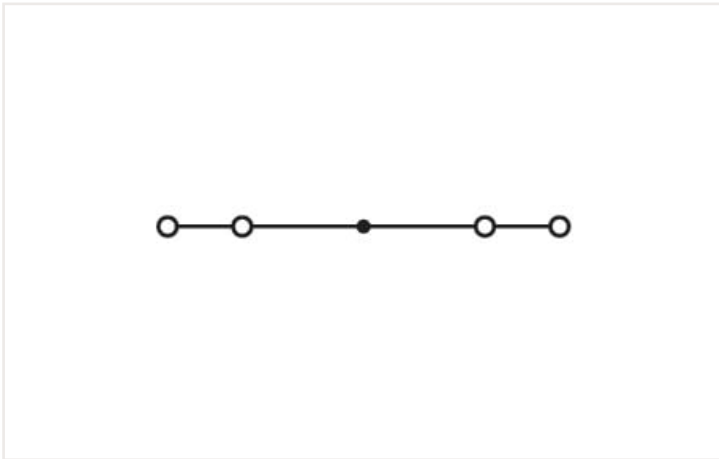
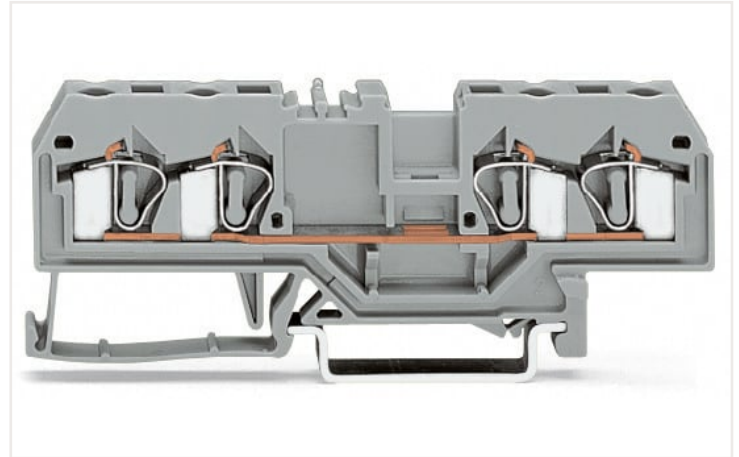
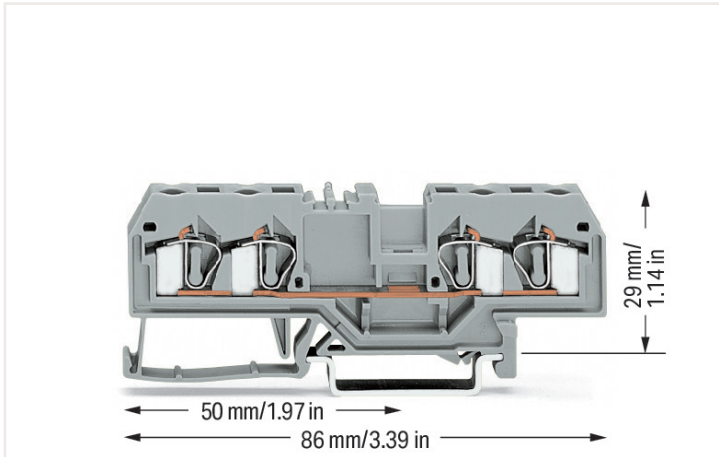

Electrical data

Ratings per IEC/EN

Ratings per	IEC/EN 60947-7-1
Nominal voltage (III/3)	800 V
Rated impulse voltage (III/3)	8 kV
Rated current	26 A
Legend (ratings)	(III / 3) ≙ Overvoltage category III / Pollution degree 3

Power loss

Power loss, per pole (potential)	0.676 W
Rated current I_N for specified power loss	26 A
Resistance value for specified, current-dependent power loss	0.001 Ω

Connection data

Connection points	4
Total number of potentials	1
Number of levels	1

Connection 1

Connection technology	CAGE CLAMP®
Actuation type	Operating tool
Connectable conductor materials	Copper Aluminum

Connection 1

Connectable conductor materials (note)

Terminating Aluminum Conductors

WAGO spring clamp terminal blocks are suitable for solid aluminum conductors up to 4 mm²/12 AWG if WAGO "Alu-Plus" Contact Paste [249-130](#) is used for termination.

"Alu-Plus" Contact Paste Advantages:

- Automatically destroys the oxide film during clamping.
- Prevents fresh oxidation at the clamping point.
- Prevents electrolytic corrosion between aluminum and copper conductors (in the same terminal block).
- Provides long-term protection against corrosion.

Using terminal blocks with CAGE CLAMP® Spring Pressure Connection Technology, **aluminum conductors must first be cleaned with a blade** and then immediately be inserted into the clamping units filled with "Alu-Plus" Contact Paste.

It is also possible to apply WAGO "Alu-Plus" **additionally** on the whole surface of the aluminum conductor before termination.

Please note that the nominal currents must be adapted to the reduced conductivity of the aluminum conductors::

2.5 mm² = 16 A

4 mm² = 22 A

Solid conductor	0.08 ... 4 mm ² / 28 ... 12 AWG
Fine-stranded conductor	0.08 ... 4 mm ² / 28 ... 12 AWG
Strip length	9 ... 10 mm / 0.35 ... 0.39 inches
Wiring direction	Front-entry wiring

Physical data

Width	6 mm / 0.236 inches
Height	86 mm / 3.386 inches
Depth from upper-edge of DIN-rail	29 mm / 1.142 inches

Mechanical data

Design	horizontal type
Mounting type	DIN-35 rail
Marking level	Center marking

Material data

Note (material data)	Information on material data can be found here
Color	gray
Material group	I
Insulation material	Polyamide (PA66)
Flammability class per UL94	V0
Fire load	0.21 MJ
Weight	12.6 g

Environmental requirements

Processing temperature	-35 ... +85 °C
Continuous operating temperature	-60 ... +105 °C

Commercial data

Product Group	1 (Rail Mounted Terminal Blocks)
eCl@ss 10.0	27-14-11-20
eCl@ss 9.0	27-14-11-20
ETIM 8.0	EC000897
ETIM 7.0	EC000897
PU (SPU)	50 Stück
Packaging type	Box
Country of origin VKOrg Germany	DE
GTIN	4044918486354
Customs tariff number VKOrg Germany	85369010000

Approvals and certificates

General approvals



Approval	Standard	Certificate name
CCA DEKRA Certification B.V.	EN 60947, IEC 60947	NTR NL-7454/A1
CSA DEKRA Certification B.V.	C22.2 No. 158	1505034
KEMA/KEUR DEKRA Certification B.V.	EN 60947	71-107288
UL Underwriters Laboratories Inc.	UL 1059	E45172

Approvals for marine applications



Approval	Standard	Certificate name
ABS American Bureau of Shipping	-	20-HG1941090-PDA
DNV GL Det Norske Veritas, Germanischer Lloyd	-	TAE00001V2
LR Lloyds Register	EN 60947	91/20112 (E9)

Downloads

Environmental Product Compliance

Compliance Search

Environmental Product
Compliance 281-652



Documentation

Additional Information

Technical Section pdf
2142.18 KB



Bid Text

281-652	19.02.2019	xml 3.17 KB	
281-652	28.02.2017	doc 24.00 KB	

CAD/CAE-Data

CAD data	CAE data
2D/3D Models 281-652	EPLAN Data Portal 281-652
	WSCAD Universe 281-652
	ZUKEN Portal 281-652

1 Compatible products

1.1 Required accessories

1.1.1 End plate

1.1.1.1 End plate

Item no.: 281-334 End and intermediate plate; 2.5 mm thick; gray	Item no.: 281-335 End and intermediate plate; 2.5 mm thick; orange	Item no.: 281-338 Separator plate; 2 mm thick; oversized; gray	Item no.: 281-339 Separator plate; 2 mm thick; oversized; orange
Item no.: 284-336 Step-down cover plate; 1 mm thick; for 4-conductor 279-831, 280-833 and 281-652 terminal blocks; gray	Item no.: 284-346 Step-down cover plate; 1 mm thick; for 4-conductor 279-831, 280-833 and 281-652 terminal blocks; orange		

1.2 Optional accessories

1.2.1 DIN-rail

1.2.1.1 Mounting accessories

Item no.: 210-196 Aluminum carrier rail; 35 x 8.2 mm; 1.6 mm thick; 2 m long; unslotted; similar to EN 60715; silver-colored	Item no.: 210-198 Copper carrier rail; 35 x 15 mm; 2.3 mm thick; 2 m long; unslotted; according to EN 60715; copper-colored	Item no.: 210-508 Steel carrier rail; 35 x 15 mm; 1.5 mm thick; 2 m long; slotted; galvanized; similar to EN 60715; silver-colored	Item no.: 210-197 Steel carrier rail; 35 x 15 mm; 1.5 mm thick; 2 m long; slotted; similar to EN 60715; silver-colored
Item no.: 210-506 Steel carrier rail; 35 x 15 mm; 1.5 mm thick; 2 m long; unslotted; galvanized; similar to EN 60715; silver-colored	Item no.: 210-114 Steel carrier rail; 35 x 15 mm; 1.5 mm thick; 2 m long; unslotted; similar to EN 60715; silver-colored	Item no.: 210-118 Steel carrier rail; 35 x 15 mm; 2.3 mm thick; 2 m long; unslotted; according to EN 60715; silver-colored	Item no.: 210-115 Steel carrier rail; 35 x 7.5 mm; 1 mm thick; 2 m long; slotted; according to EN 60715; "Hole width 18 mm; silver-colored
Item no.: 210-112 Steel carrier rail; 35 x 7.5 mm; 1 mm thick; 2 m long; slotted; according to EN 60715; "Hole width 25 mm; silver-colored	Item no.: 210-504 Steel carrier rail; 35 x 7.5 mm; 1 mm thick; 2 m long; slotted; galvanized; according to EN 60715; silver-colored	Item no.: 210-113 Steel carrier rail; 35 x 7.5 mm; 1 mm thick; 2 m long; unslotted; according to EN 60715; silver-colored	Item no.: 210-505 Steel carrier rail; 35 x 7.5 mm; 1 mm thick; 2 m long; unslotted; galvanized; according to EN 60715; silver-colored

1.2.2 Ferrule

1.2.2.1 Ferrule



Item no.: 216-301

Ferrule; Sleeve for 0.25 mm² / AWG 24; insulated; electro-tin plated; yellow



Item no.: 216-302

Ferrule; Sleeve for 0.34 mm² / 22 AWG; insulated; electro-tin plated; light turquoise



Item no.: 216-241

Ferrule; Sleeve for 0.5 mm² / 20 AWG; insulated; electro-tin plated; electrolytic copper; gastight crimped; acc. to DIN 46228, Part 4/09.90; white



Item no.: 216-201

Ferrule; Sleeve for 0.5 mm² / 20 AWG; insulated; electro-tin plated; white



Item no.: 216-242

Ferrule; Sleeve for 0.75 mm² / 18 AWG; insulated; electro-tin plated; electrolytic copper; gastight crimped; acc. to DIN 46228, Part 4/09.90; gray



Item no.: 216-202

Ferrule; Sleeve for 0.75 mm² / 18 AWG; insulated; electro-tin plated; gray



Item no.: 216-243

Ferrule; Sleeve for 1 mm² / AWG 18; insulated; electro-tin plated; electrolytic copper; gastight crimped; acc. to DIN 46228, Part 4/09.90; red



Item no.: 216-203

Ferrule; Sleeve for 1 mm² / AWG 18; insulated; electro-tin plated; red



Item no.: 216-204

Ferrule; Sleeve for 1.5 mm² / AWG 16; insulated; electro-tin plated; black



Item no.: 216-244

Ferrule; Sleeve for 1.5 mm² / AWG 16; insulated; electro-tin plated; electrolytic copper; gastight crimped; acc. to DIN 46228, Part 4/09.90; black



Item no.: 216-205

Ferrule; Sleeve for 2.08 mm² / AWG 14; insulated; electro-tin plated; yellow



Item no.: 216-206

Ferrule; Sleeve for 2.5 mm² / AWG 14; insulated; electro-tin plated; blue



Item no.: 216-246

Ferrule; Sleeve for 2.5 mm² / AWG 14; insulated; electro-tin plated; electrolytic copper; gastight crimped; acc. to DIN 46228, Part 4/09.90; blue



Item no.: 216-106

Ferrule; Sleeve for 2.5 mm² / AWG 14; un-insulated; electro-tin plated; silver-colored

1.2.3 Installation

1.2.3.1 Mounting accessories



Item no.: 709-167

Cover carrier; Type 1; incl. fixing/retaining screws and knurled nut; suitable for 279 to 282 and 880 Series rail-mounted terminal blocks; suitable for 264 Series miniature rail-mounted terminal blocks; suitable for 270 Series sensor and actuator terminal blocks; gray



Item no.: 709-153

Cover; Type 1; suitable for cover carrier, type 1; 1 m long; transparent



Item no.: 209-106

Mounting carrier; for isolated mounting on DIN 35 rails; gray



Item no.: 249-116

Screwless end stop; 6 mm wide; for DIN-rail 35 x 15 and 35 x 7.5; gray

1.2.4 Insulation stop

1.2.4.1 Insulation stop



Item no.: 281-470

Insulation stop; 0.08 - 0.2 mm² "s" (0.14 mm² "f-st"); 5 pieces/strip; white



Item no.: 281-471

Insulation stop; 0.25 - 0.5 mm²; 5 pieces/strip; light gray



Item no.: 281-472

Insulation stop; 0.75 - 1.5 mm²; 5 pieces/strip; dark gray

1.2.5 Jumper

1.2.5.1 Jumper



Item no.: 281-490
Jumper; 10-way; insulated; gray



Item no.: 281-482
Jumper; 2-way; insulated; gray



Item no.: 281-492
Jumper; 2-way; insulated; gray



Item no.: 281-483
Jumper; 3-way; insulated; gray



Item no.: 281-485
Jumper; 5-way; insulated; gray



Item no.: 281-402
Jumper; insulated; gray



Item no.: 281-409
Jumper; insulated; gray



Item no.: 281-422
Jumper; insulated; yellow-green



Item no.: 781-452
Staggered jumper; from 1 to 2; insulated; gray



Item no.: 781-453
Staggered jumper; from 1 to 3; insulated; gray



Item no.: 781-454
Staggered jumper; from 1 to 4; insulated; gray



Item no.: 781-455
Staggered jumper; from 1 to 5; insulated; gray



Item no.: 781-456
Staggered jumper; from 1 to 6; insulated; gray



Item no.: 283-414
Step-down jumper; from 283 to 281 series; insulated; gray



Item no.: 284-414
Step-down jumper; from 284/282 to 281/280/279 series; insulated; gray



Item no.: 709-110
Wire commoning chain; 2.5 mm²; insulated; black



Item no.: 709-111
Wire commoning chain; 2.5 mm²; insulated; black



Item no.: 709-112
Wire commoning chain; 2.5 mm²; insulated; black



Item no.: 210-103
Wire commoning chain; insulated; black



Item no.: 210-123
Wire commoning chain; insulated; blue

1.2.6 Marking

1.2.6.1 Group marker carrier



Item no.: 209-140
Group marker carrier; gray



Item no.: 209-141
Group marker carrier; gray



Item no.: 209-142
Group marker carrier; gray



Item no.: 249-105
Group marker carrier; gray

1.2.6.2 Marker



Item no.: 793-5501/000-006
WMB marking card; as card; for terminal block width 5 - 17.5 mm; stretchable 5 - 5.2 mm; plain; snap-on type; blue



Item no.: 793-5501/000-007
WMB marking card; as card; for terminal block width 5 - 17.5 mm; stretchable 5 - 5.2 mm; plain; snap-on type; gray



Item no.: 793-5501/000-023
WMB marking card; as card; for terminal block width 5 - 17.5 mm; stretchable 5 - 5.2 mm; plain; snap-on type; green



Item no.: 793-5501/000-017
WMB marking card; as card; for terminal block width 5 - 17.5 mm; stretchable 5 - 5.2 mm; plain; snap-on type; light green



Item no.: 793-5501/000-012
WMB marking card; as card; for terminal block width 5 - 17.5 mm; stretchable 5 - 5.2 mm; plain; snap-on type; orange



Item no.: 793-5501/000-005
WMB marking card; as card; for terminal block width 5 - 17.5 mm; stretchable 5 - 5.2 mm; plain; snap-on type; red



Item no.: 793-5501/000-024
WMB marking card; as card; for terminal block width 5 - 17.5 mm; stretchable 5 - 5.2 mm; plain; snap-on type; violet



Item no.: 793-5501
WMB marking card; as card; for terminal block width 5 - 17.5 mm; stretchable 5 - 5.2 mm; plain; snap-on type; white



Item no.: 793-5501/000-002
WMB marking card; as card; for terminal block width 5 - 17.5 mm; stretchable 5 - 5.2 mm; plain; snap-on type; yellow



Item no.: 793-501/000-006
WMB marking card; as card; not stretchable; plain; snap-on type; blue



Item no.: 793-501/000-007
WMB marking card; as card; not stretchable; plain; snap-on type; gray



Item no.: 793-501/000-023
WMB marking card; as card; not stretchable; plain; snap-on type; green



Item no.: 793-501/000-017
WMB marking card; as card; not stretchable; plain; snap-on type; light green



Item no.: 793-501/000-012
WMB marking card; as card; not stretchable; plain; snap-on type; orange



Item no.: 793-501/000-005
WMB marking card; as card; not stretchable; plain; snap-on type; red



Item no.: 793-501/000-024
WMB marking card; as card; not stretchable; plain; snap-on type; violet



Item no.: 793-501
WMB marking card; as card; not stretchable; plain; snap-on type; white



Item no.: 793-501/000-002
WMB marking card; as card; not stretchable; plain; snap-on type; yellow



Item no.: 2009-115/000-006
WMB-Inline; for Smart Printer; 1500 pieces on roll; stretchable 5 - 5.2 mm; plain; snap-on type; blue



Item no.: 2009-115/000-007
WMB-Inline; for Smart Printer; 1500 pieces on roll; stretchable 5 - 5.2 mm; plain; snap-on type; gray

1.2.6.2 Marker



Item no.: 2009-115/000-023
WMB-Inline; for Smart Printer; 1500 pieces on roll; stretchable 5 - 5.2 mm; plain; snap-on type; green



Item no.: 2009-115/000-017
WMB-Inline; for Smart Printer; 1500 pieces on roll; stretchable 5 - 5.2 mm; plain; snap-on type; light green



Item no.: 2009-115/000-012
WMB-Inline; for Smart Printer; 1500 pieces on roll; stretchable 5 - 5.2 mm; plain; snap-on type; orange



Item no.: 2009-115/000-024
WMB-Inline; for Smart Printer; 1500 pieces on roll; stretchable 5 - 5.2 mm; plain; snap-on type; violet



Item no.: 2009-115
WMB-Inline; for Smart Printer; 1500 pieces on roll; stretchable 5 - 5.2 mm; plain; snap-on type; white



Item no.: 2009-115/000-002
WMB-Inline; for Smart Printer; 1500 pieces on roll; stretchable 5 - 5.2 mm; plain; snap-on type; yellow

1.2.7 Protective warning marker

1.2.7.1 Cover



Item no.: 281-415
Protective warning marker; for 5 terminal blocks; with high-voltage symbol, black; yellow

1.2.8 Push-in type wire jumper

1.2.8.1 Jumper

Item no.: 249-126
Push-in type wire jumper; 0.75 mm²; insulated; 110 mm long; black

Item no.: 249-123
Push-in type wire jumper; 0.75 mm²; insulated; 180 mm long; black

Item no.: 249-127
Push-in type wire jumper; 0.75 mm²; insulated; 250 mm long; black

Item no.: 249-125
Push-in type wire jumper; insulated; 60 mm long; black

1.2.9 Test and measurement

1.2.9.1 Testing accessories



Item no.: 249-148
B-type spacer module; modular; e.g., for bridging commoned terminal blocks; gray



Item no.: 249-147
B-type test plug module; modular; 2,50 mm²; gray



Item no.: 249-145
L-type end module; modular; with rigid contact pin; End module; 2,50 mm²; gray



Item no.: 249-146
L-type spacer module; modular; e.g., bridging commoned terminal blocks; gray



Item no.: 249-144
L-type test plug module; modular; with spring-loaded contact pin; Center module; 2,50 mm²; gray



Item no.: 281-419
Spacer module; modular; bridging commoned terminal blocks; gray



Item no.: 280-404
Test plug adapter; 5 mm wide; for test plug (2.3 mm Ø); suitable for 1.5 mm² - 4 mm² tbs; gray



Item no.: 209-170
Test plug adapter; 8.3 mm wide; for 4 mm Ø test plugs; suitable for 1.5 mm² - 10 mm² tbs; gray



Item no.: 281-418
Test plug module; modular; suitable for all WAGO 281, 776, 777 and 781 series rail-mounted terminal blocks with jumper slots in the current bar; gray



Item no.: 281-407
Test plug; 6 mm wide; Nominal current 24 A; for 0.08 mm² - 2.5 mm²; 2,50 mm²; gray

1.2.10 Tool

1.2.10.1 Operating tool



Item no.: 210-658

Operating tool; Blade: 3.5 x 0.5 mm; with a partially insulated shaft; angled; short; multicoloured

Item no.: 210-720

Operating tool; Blade: 3.5 x 0.5 mm; with a partially insulated shaft; multicoloured

Item no.: 210-657

Operating tool; Blade: 3.5 x 0.5 mm; with a partially insulated shaft; short; multicoloured

Installation notes

Installation

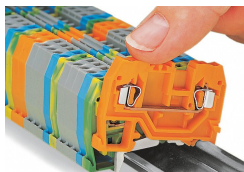

Snapping a terminal block onto the DIN-rail.

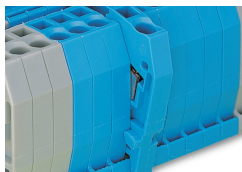

Quick assembly keys prevent reverse mounting.

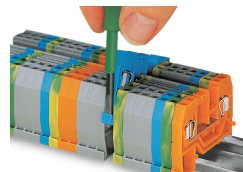

Removing a terminal block from the assembly.



Steel DIN-rails are not suited for PEN (ground and N-conductor) applications per EN 60947-7-2 (VDE 0611, Part 3).

Conductor termination

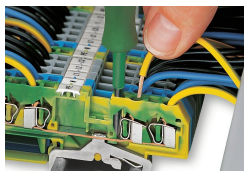

CAGE CLAMP® connection
Inserting a conductor.

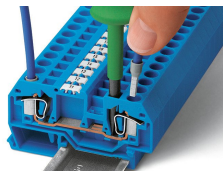

CAGE CLAMP® connection
Inserting a conductor.
With ferruled conductors, it is necessary to use a terminal block one size larger than the conductor's nominal cross-section.

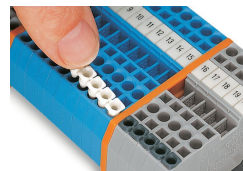

Inserting insulation stops.

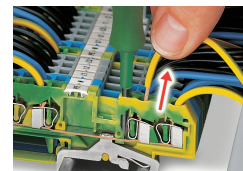

CAGE CLAMP® connection
Removing a solid conductor.

Testing

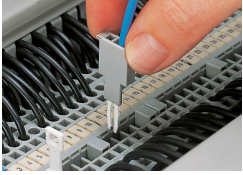

Testing with a test plug. Picture shows a test plug fitted with CAGE CLAMP®.

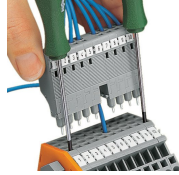

L-type test plug modules fitted with CAGE CLAMP®

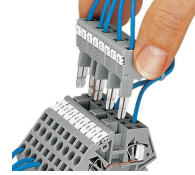

B-type test plug modules fitted with CAGE CLAMP®

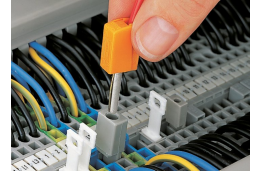

Testing with a test plug. Picture shows a test plug adapter (209-170).

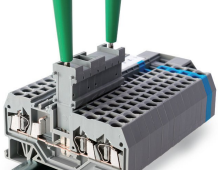

Test plugs modules are directly plugged into the jumper contact slot of the current bar.

Cover

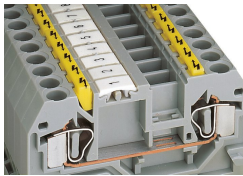

Protective warning markers inserted into the operating slots

Marking

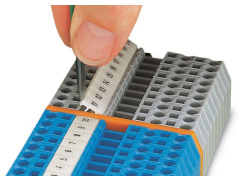

Labeling via WMB Multi Marking System.

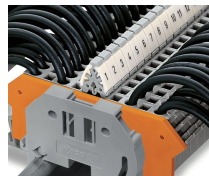

Terminal block marking with double marker carriers (209-128) Terminal blocks with side marking