

THIS DRAWING IS UNPUBLISHED.

RELEASED FOR PUBLICATION

20

© COPYRIGHT 20 BY -

ALL RIGHTS RESERVED.

REVISIONS

P	LTR	DESCRIPTION	DATE	DWN	APVD
	H2	REDRAWN (ECR-15-005089)	09APR2015	M.G.	M.G.

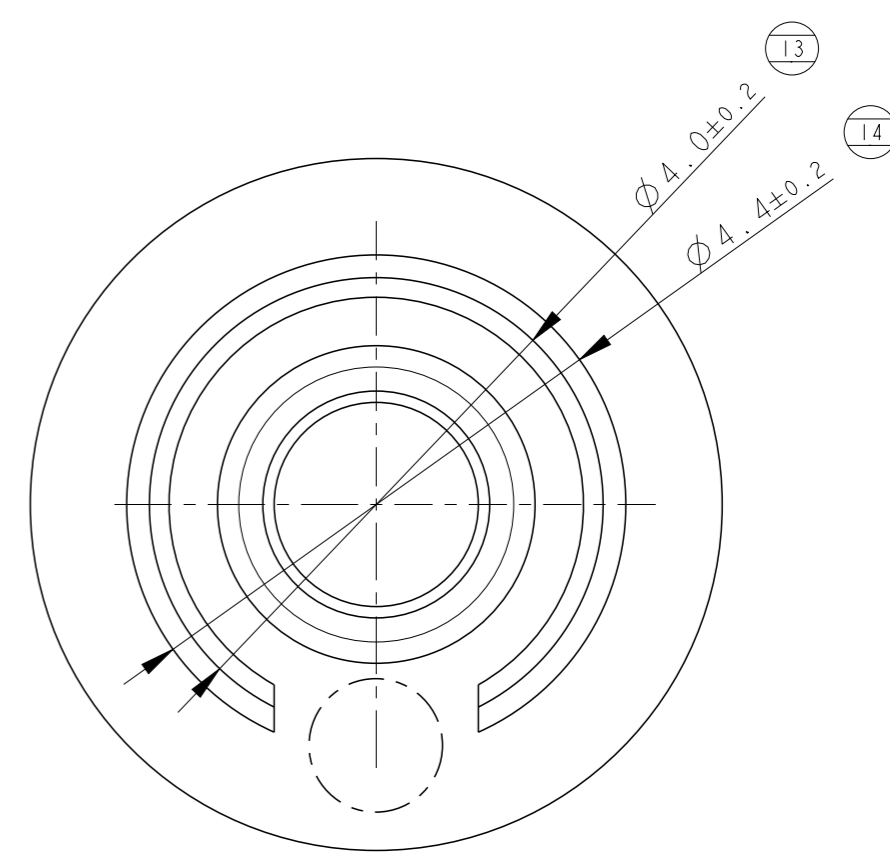
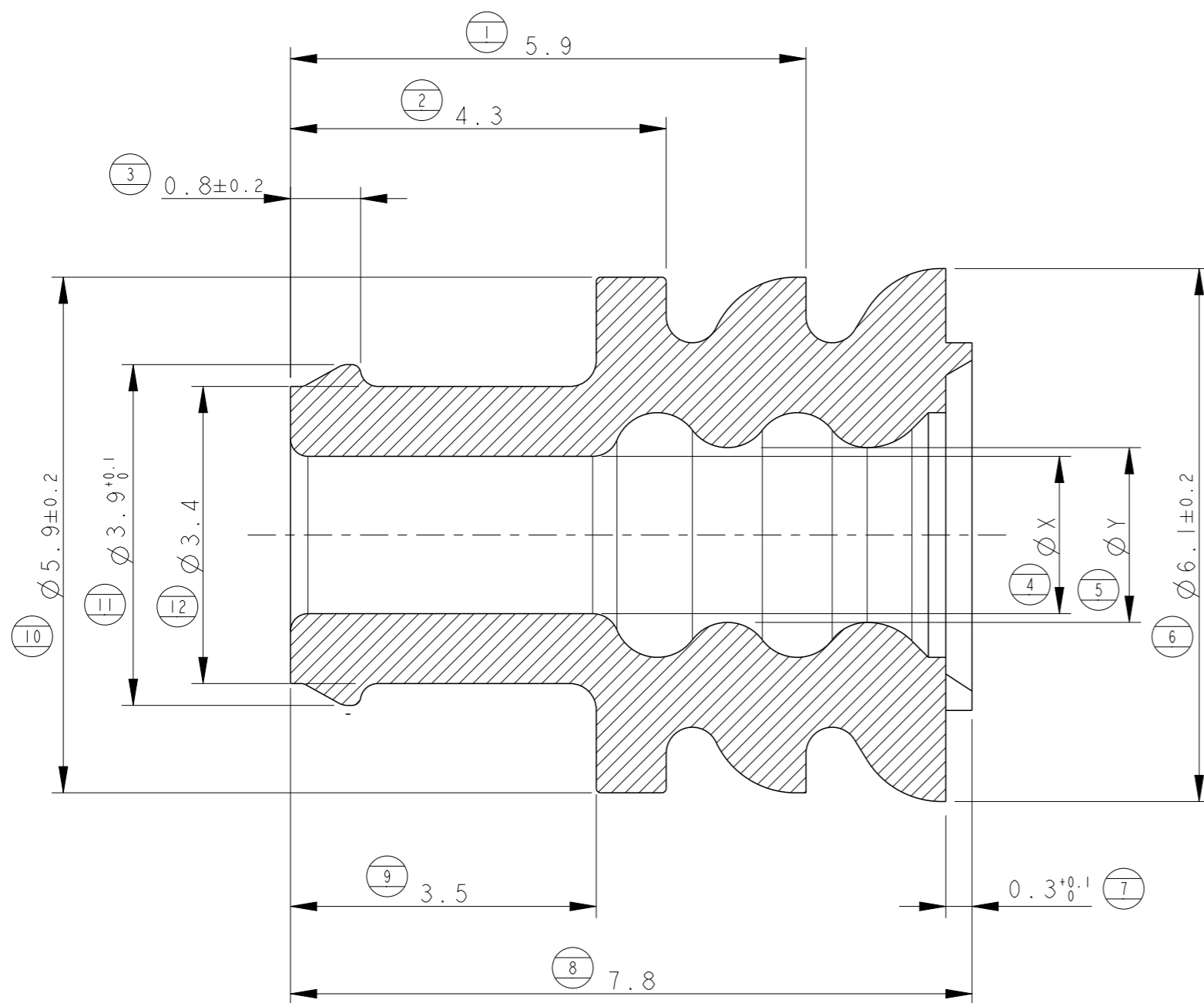

SCALE 5:1

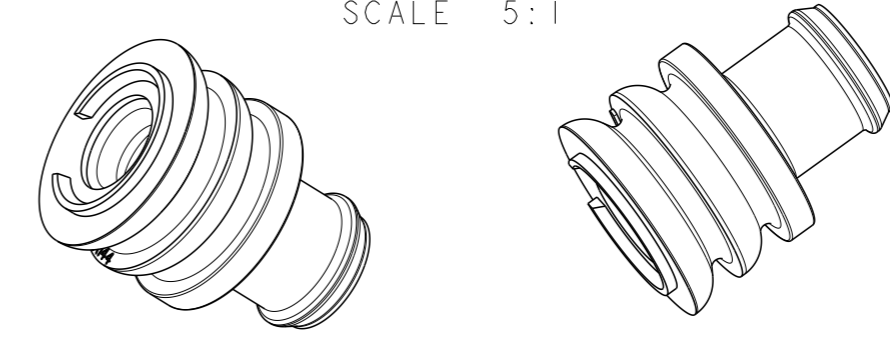

SUITABLE FOR INS. DIA	DIM. "Y"	DIM. "X"	COLOUR	MATERIAL	REV.	P/N
1.2 - 1.6	1.0 ± 0.2	1.0 ± 0.2	WHITE	FLUORSILICONE RUBBER (FSL)	H	281934-5
			GREEN		H	281934-4
2.5 - 3.3	2.0 ± 0.2	1.8 ± 0.2	RED	SILICONE RUBBER (LSR)	H	281934-3
1.7 - 2.4	1.4 ± 0.2	1.4 ± 0.2	YELLOW		H	281934-2

THIS DRAWING IS A CONTROLLED DOCUMENT.

DIMENSIONS: mm

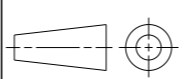

MATERIAL SEE TABLE

TOLERANCES UNLESS OTHERWISE SPECIFIED:	
0 PLC	±0.3
1 PLC	±0.3
2 PLC	±-
3 PLC	±-
4 PLC	±-
ANGLES	±2°
FINISH	-

DWN	C. BERTINI	12-'88
CHK	A. BRUNI	05-'92
APVD	-	-
PRODUCT SPEC	-	-
APPLICATION SPEC	-	-
WEIGHT	-	-
Customer Drawing		

		TE Connectivity	
		NAME SINGLE WIRE SEAL	
SIZE	A3	CAGE CODE	-
DRAWING NO	C-281934	RESTRICTED TO	-
SCALE	15:1	SHEET	1 OF 1
REV	H2		

Mouser Electronics

Authorized Distributor

Click to View Pricing, Inventory, Delivery & Lifecycle Information:

[TE Connectivity:](#)

[281934-3](#)