

KBP2005G-G Thru. KBP210G-G

Reverse Voltage: 50 to 1000V

Forward Current: 2.0 Amp

RoHS Device

Features

- Surge overload rating -60 amperes peak.
- Ideal for printed circuit board.
- UL recognized file # E349301

Mechanical Data

- Case: Molded plastic body over passivated junctions.
- Epoxy: UL 94V-0 rate flame retardant.
- Polarity: Polarity symbols marked on case.
- Mounting position: Any

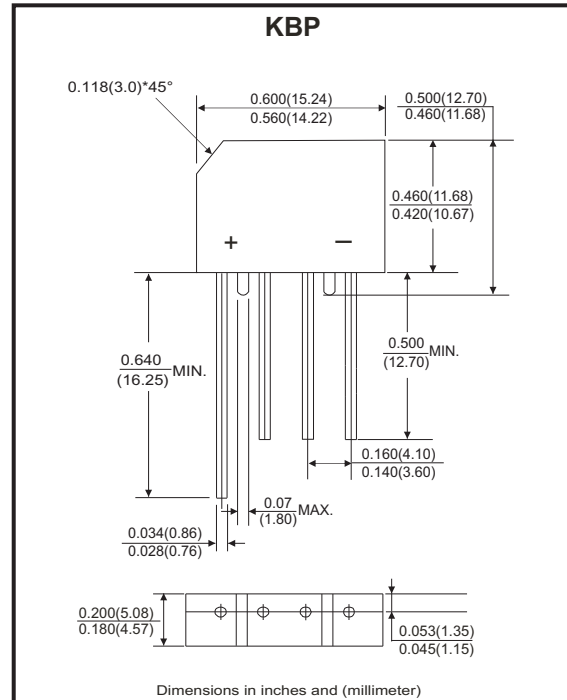

Maximum ratings and electrical characteristics

Rating at 25°C ambient temperature unless otherwise specified.
 Single phase, half wave, 60Hz, resistive or inductive load.
 For capacitive load, derate current by 20%

Parameter	Symbol	KBP 2005G-G	KBP 201G-G	KBP 202G-G	KBP 204G-G	KBP 206G-G	KBP 208G-G	KBP 210G-G	Unit
Maximum Recurrent Peak Reverse Voltage	V_{RRM}	50	100	200	400	600	800	1000	V
Maximum RMS Bridge Input Voltage	V_{RMS}	35	70	140	280	420	560	700	V
Maximum DC Blocking Voltage	V_{DC}	50	100	200	400	600	800	1000	V
Maximum Average Forward Rectified Output Current @ $T_A=50^\circ C$	$I_{(AV)}$	2.0							A
Peak Forward Surge Current, 8.3ms Single Half Sine-Wave Super Imposed On Rated Load	I_{FSM}	60							A
Maximum Forward Voltage Drop Per Bridge Element at 2.0A Peak	V_F	1.1							V
Maximum Reverse Current at Rated DC Blocking Voltage Per Element	I_R	10.0							μA
Maximum Reverse Current at Rated DC Blocking Voltage Per Element @ $T_J=100^\circ C$	I_R	1.0							mA
Operating Temperature Range	T_J	-55 to +150							$^\circ C$
Storage Temperature Range	T_{STG}	-55 to +150							$^\circ C$

Company reserves the right to improve product design, functions and reliability without notice.

REV: C

Rating and Characteristics Curves (KBP2005G-G Thru. KBP210G-G)

Fig.1 - Derating Curve Output Rectified Current

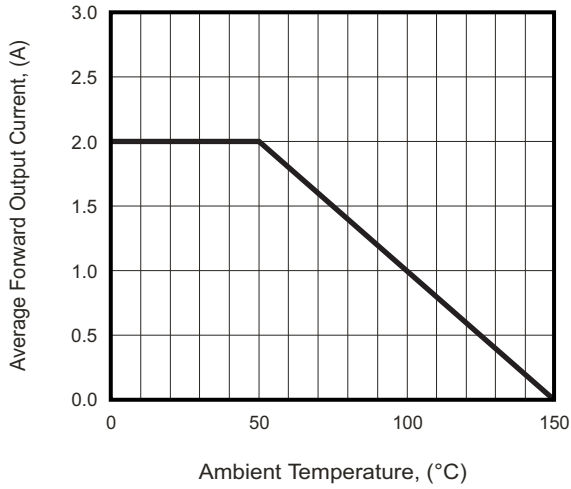

Fig.2 - Max. Forward Surge Current

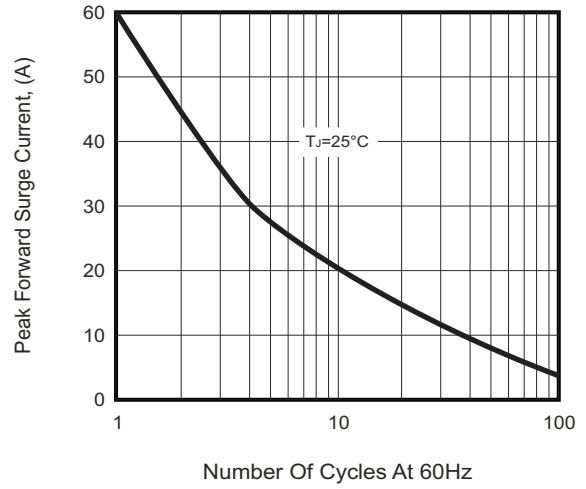

Fig.3 - Typical Forward Characteristics

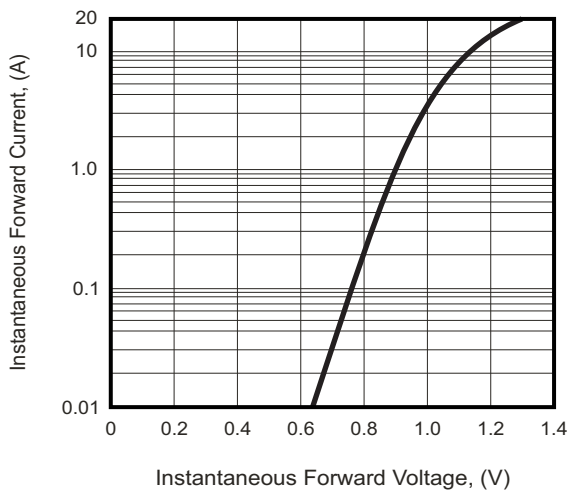
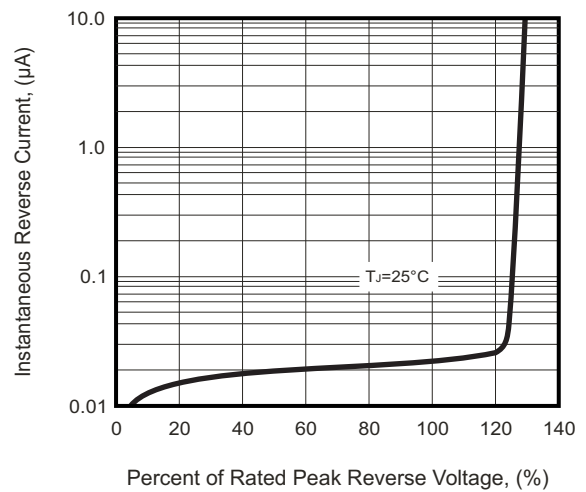
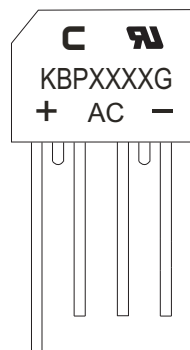

Fig.4 - Typical Reverse Characteristics



Marking Code

Part Number	Marking code
KBP2005G-G	KBP2005G
KBP201G-G	KBP201G
KBP202G-G	KBP202G
KBP204G-G	KBP204G
KBP206G-G	KBP206G
KBP208G-G	KBP208G
KBP210G-G	KBP210G



XXX / XXXX = Product type marking code

C = Compchip Logo

Standard Packaging

Case Type	BULK PACK	
	BOX (pcs)	CARTON (pcs)
KBP	500	5,000

Case Type	TUBE PACK	
	TUBE (pcs)	BOX (pcs)
KBP	30	1,200

Mouser Electronics

Authorized Distributor

Click to View Pricing, Inventory, Delivery & Lifecycle Information:

[Comchip Technology:](#)

[KBP204G-G](#)